



Trimble TX6/TX8

3D Laser Scanner

USER GUIDE

Version 1.00
Revision B
May 2017

Corporate Office

Trimble Inc.
935 Stewart Drive
Sunnyvale, CA 94085
USA
www.trimble.com

GeoSpatial business area

Trimble Inc.
GeoSpatial business area
10355 Westmoor Drive,
Suite #100
Westminster, CO 80021
USA
800-538-7800 (toll free in USA)
+1-937-245-5600 Phone
+1-937-233-9004 Fax
<http://www.trimble.com/support/>

Legal Notices

© 2017, Trimble Inc. All rights reserved.

Trimble, the Globe & Triangle logo, and RealWorks are trademarks of Trimble Inc., registered in the United States and in other countries.

All other trademarks are the property of their respective owners.

Release Notice

This is the May 2017 release (Revision B) of the Trimble TX6/TX8 3D Laser Scanner User Guide. It applies to version 1.00 of the 3D Laser Scanner.

Product Limited Warranty Information

For applicable product Limited Warranty information, please refer to the Limited Warranty Card included with this Trimble product, or consult your local Trimble authorized dealer.

Notices

USA

Class B Statement – Notice to Users. This equipment has been tested and found to comply with the limits for a Class B digital device, pursuant to Part 15 of the FCC rules and Part 90. These limits are designed to provide reasonable protection against harmful interference in a residential installation. This equipment generates, uses, and can radiate radio frequency energy and, if not installed and used in accordance with the instructions, may cause harmful interference to radio communication. However, there is no guarantee that interference will not occur in a particular installation. If this equipment does cause harmful interference to radio or television reception, which can be determined by turning the equipment off and on, the user is

encouraged to try to correct the interference by one or more of the following measures:

- Increase the separation between the equipment and the receiver.
- Connect the equipment into an outlet on a circuit different from that to which the receiver is connected.
- Consult the dealer or an experienced radio/TV technician for help.

Changes and modifications not expressly approved by the manufacturer or registrant of this equipment can void your authority to operate this equipment under Federal Communications Commission rules.

Canada

This Class B digital apparatus complies with Canadian ICES-003.

Cet appareil numérique de la classe B est conforme à la norme NMB-003 du Canada.

Europe

The Product has been tested and found to comply with the requirements for a Class B device pursuant to European Council Directive 2014/30/EU on EMC.



The Product complies with European Council Directive 2006/42/EC on Machinery and European Council Directive 2011/65 (RoHS).

Australia and New Zealand

This product conforms with the regulatory requirements of the Australian Communications and Media Authority (ACMA) EMC framework, thus satisfying the requirements for RCM Marking and sale within Australia and New Zealand.



Taiwan – Battery Recycling Requirements

The product contains a removable Lithium-ion battery. Taiwanese regulations require that waste batteries are recycled.



廢電池請回收

Waste Electrical and Electronic Equipment (WEEE)

For product recycling instructions and more information, please go to www.trimble.com/Corporate/Environmental_Compliance.aspx.



Recycling in Europe: To recycle Trimble WEEE (Waste Electrical and Electronic Equipment, products that run on electrical power.), Call +31 497 53 24 30, and ask for the "WEEE Associate". Or, mail a request for recycling instructions to:

Trimble Europe BV
c/o Menlo Worldwide Logistics
Meerheide 45
5521 DZ Eersel, NL

FCC Declaration of Conformity

We, Trimble Inc.
935 Stewart Drive
PO Box 3642
Sunnyvale, CA 94088-3642
United States
+1-408-481-8000

Declare under sole responsibility that DoC products comply with Part 15 of FCC Rules.

Operation is subject to the following two conditions:

- (1) This device may not cause harmful interference, and
- (2) This device must accept any interference received, including interference that may cause undesired operation.

Declaration of Conformity (laser performance)

This is to certify that 3D scanner model Trimble TX6 and TX8 complies with the performance requirements of IEC 60825-1 ⁽¹⁾ and US FDA 21 CFR §1040.10 ⁽²⁾ as a Class 1 laser device.

⁽¹⁾ IEC 60825-1: 2014 Edition 2.0. Safety of laser products - Part 1: Equipment classification and requirements. IEC, Geneva.

⁽²⁾ Federal Performance Standard for Laser Products, 21 §CFR 1040.10, Center for Devices and Radiological Health, Silver Springs, Maryland, USA.

EC Declaration of Conformity

We, Trimble (MENSI S.A.S.)
174 avenue du Maréchal de Lattre de Tassigny
94120 Fontenay-sous-Bois
France

Declare under sole responsibility that the product, Trimble TX6, part number 28010049, and Trimble TX8, part number 28020049 are in conformity with the following European standards:

Electromagnetic Compatibility:

Standard NF EN 61326-1 (July 2006)

In compliance with EMC Directive 2014/30/EU.

In compliance with Machinery Directive 2006/42/EC.

In compliance with RoHS Directive 2011/65 (RoHS).

In compliance with RTTE Directive 1999/5/ED

Environment: Electrical equipment for measurement, control and laboratory use

Conformity has been demonstrated on one production representative sample. Conformity to EMC standards of each manufactured unit is ensured by implementation of internal documented procedures.

Safety Information

Before you use your Trimble product, make sure that you have read the user manual and understood all safety requirements. Failure to follow the instructions, warnings and precautions may lead to device damage, and/or user injury.

 **WARNING** – This alert warns of a potential hazard which, if not avoided, could result in severe injury or even death.

 **CAUTION** – This alert warns of a potential hazard or unsafe practice that could result in minor injury or property damage or irretrievable data loss.

NOTE – *An absence of specific alerts does not mean that there are no safety risks involved.*

Use and care

This product is designed to withstand the rough treatment and tough environment that typically occurs in construction applications. However, the scanner is a high-precision electronic instrument and should be treated with reasonable care.

Also see, [Care and maintenance](#).

 **CAUTION** – Operating or storing the instrument outside the specified temperature range can damage it.

 **CAUTION** – Please read carefully the manual before using the instrument. Failure to follow the instructions, warnings and precautions that are in the manual may lead to device damage, and/or user injury.

Laser safety

This is to certify that the 3D scanner model, Trimble TX6 and TX8, comply with the performance requirements of IEC 60825-1¹ and US FDA 21 CFR §1040.10² as a Class 1 laser device.

¹IEC 60825-1: 2014 Edition 2.0. Safety of laser products - Part 1: Equipment classification and requirements. IEC, Geneva.

²Federal Performance Standard for Laser Products, 21 §CFR 1040.10, Center for Devices and Radiological Health, Silver Springs, Maryland, USA.

Hazard label



This label is placed on each side of the instrument. It warns you to keep your hands away from moving parts when the instrument is rotating. Failure to follow the instruction may cause injury to yourself or damage to the instrument.

Class 1 Laser Product label



The TX 3D scanner complies with the performance requirements of international standard IEC 60825-1 2014 as a CLASS 1 LASER PRODUCT and is therefore labeled as follows in accordance with the requirements of this standard. The Laser Warning Label is placed on the bottom and back of the instrument.

The TX 3D scanner operates in a laser wavelength of 1,5 μm (invisible light), with a beam divergence of 0.177 mrad Gaussian and an output laser power of 6 kW peak.

Battery safety

 **WARNING** – Do not damage the rechargeable Lithium-ion battery. A damaged battery can cause an explosion or fire, and can result in personal injury and/or property damage. To prevent injury or damage:

- Do not use or charge the battery if it appears to be damaged. Signs of damage include, but are not limited to, discoloration, warping, and leaking battery fluid.
 - Do not expose the battery to fire, high temperature, or direct sunlight.
 - Do not immerse the battery in water.
 - Do not use or store the battery inside a vehicle during hot weather.
 - Do not drop or puncture the battery.
 - Do not open the battery or short-circuit its contacts.
-

 **WARNING** – Avoid contact with the rechargeable Lithium-ion battery if it appears to be leaking. Battery fluid is corrosive, and contact with it can result in personal injury and/or property damage. To prevent injury or damage:

- If the battery leaks, avoid contact with the battery fluid.
 - If battery fluid gets into your eyes, immediately rinse your eyes with clean water and seek medical attention. Do not rub your eyes!
 - If battery fluid gets onto your skin or clothing, immediately use clean water to wash off the battery fluid.
-

 **WARNING** – Charge and use the rechargeable Lithium-ion battery only in strict accordance with the instructions. To prevent injury or damage:

- Discontinue charging a battery that gives off extreme heat or a burning odor.
 - Never attempt to remove, replace, or repair the battery yourself.
 - If the battery requires attention, send the receiver to an authorized Trimble Service Center.
 - Use the battery only in Trimble equipment that is specified to use it.
 - Use the battery only for its intended use and according to the instructions in the product description.
-

 **WARNING** – Charging or using the battery in unauthorized equipment can cause an explosion or fire, and can result in personal injury and/or equipment damage. To prevent injury and damage:

- Do not charge or use the battery if it appears to be damaged or leaking.
- Charge the battery only in a Trimble product that is specified to charge it.
- Be sure to follow all instructions that are provided with the battery charger.
- Discontinue charging a battery that gives off extreme heat or burning odor.
- Use the battery only for its intended use and according to the instructions in the product documentation.

 **WARNING** – Discharge all Trimble batteries before disposing of them. Disposal must be done in accordance with local and national guidelines.

Contents

User Guide	1
Safety Information	5
Use and care	5
Laser safety	5
Hazard label	6
Class 1 Laser Product label	6
Battery safety	7
Contents	9
1 Introduction	12
Unpacking the instrument	13
Shipping box	13
Instrument case	14
Inspecting the instrument case	15
Opening the instrument case	16
Items in the instrument case	17
Remove the instrument from the case	18
Lifting the instrument	19
Pulling the instrument case	21
Transporting the instrument	22
Packing the instrument case into the shipping box	22
Care and maintenance	23
Cleaning	23
Removing moisture	23
Technical support	24
Related information	24
2 Instrument and Accessories	25
Instrument views	26
Front of instrument	26
Back of instrument	27
Left side of instrument	28
Right side of instrument	29
Battery/USB flash drive compartment	30
Accessories	31

External power supply kit	31
USB flash drive	32
Battery kit	32
Smart battery	33
Two-bay charger	36
Tribrach	38
Micro fiber lens cleaning cloth	39
Stylus pen kit	39
TX USB external cable	39
TX Auto-Start	40
3 Setup	41
Setting up the tripod	42
Setting up the tribrach	42
Leveling the tribrach	43
Centering over a known point	44
Setting up the instrument	46
Settling down the instrument on the tribrach	47
USB flash drive	48
Inserting the USB flash drive	48
Removing the USB flash drive	49
Powering the instrument	50
Using an external power supply	50
Inserting a battery	51
Removing a battery	52
Turning the instrument on and off	53
Turning on the instrument	53
Turning off the instrument	53
Connecting the instrument to a remote device	54
Connecting to the instrument over the WLAN	54
Connecting to the instrument with a TX series cable	56
Plugging the TX Auto-Start into the instrument	59
Changing the default settings	60
Measuring the instrument heights	60
Measuring the ground-to-bottom mark distance	61
Computing the instrument height (IH)	61
4 Software	62
Touch screen	63
Projects	65

Managing projects	66
Managing stations	69
Managing scans	71
Leveling	80
Checking the leveling status of the instrument	80
Leveling the instrument	81
Activating (or deactivating) the compensator	82
Activating (or deactivating) the Auto level check	82
Scan parameters	83
Choosing a scan mode	84
Setting the color acquisition mode	86
Enabling the fixed exposure mode	87
Choosing a scan precision	87
Applying an atmospheric correction	89
Entering the instrument height	92
Using the self-timer	93
Settings	95
Setting the date and time	96
Selecting the measurement units	97
Managing the USB flash drive	97
Maintenance	99
Personal settings	103
Scanning Face	104
Setting a wireless connection	106
5 Specifications	110
Scanner only specifications	111
Shipping box specifications	112
Instrument case specifications	112
External power supply specifications	112
USB flash drive specifications	113
Battery kit specifications	113
Smart battery specifications	113
Two-bay charger specifications	114
Tribrach specifications	114
Micro fiber lens cleaning cloth specifications	115
USB cable specifications	115
Auto-Start specifications	115

Introduction

- ▶ Unpacking the instrument
- ▶ Transporting the instrument
- ▶ Care and maintenance
- ▶ Related information
- ▶ Technical support

The Trimble® TX6 and TX8 are high-performance 3D laser scanners that rapidly measures angles and distances to create three-dimensional views.

Unpacking the instrument

Shipping box

The Trimble TX 3D scanner is packed inside an instrument case, and the instrument case is transported inside a shipping box. The shipping box is a cardboard box with two foam pads—one on top and one on bottom.

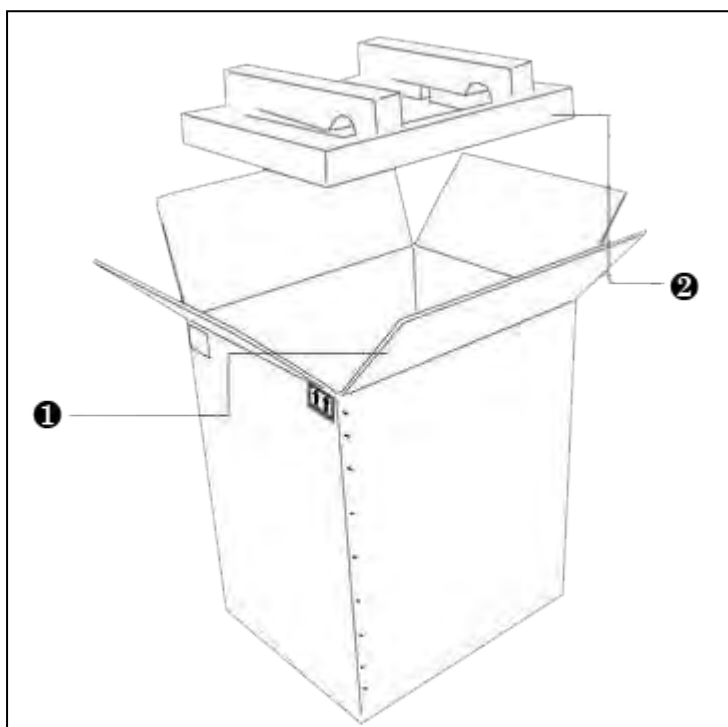

Item	Description
------	-------------

- | | |
|---|----------------|
| ❶ | Flap |
| ❷ | Foam pads (x2) |

To open the shipping box:

1. Open the seam by cutting the tape or staples.
2. Unfold the four flaps and then remove the top foam padding.

NOTE – Trimble recommends that you keep the shipping box and its foam padding in case you need to transport the instrument; the box and foam padding provide additional safety for the instrument. See [Transporting the instrument](#).

Instrument case

The instrument case is made of lightweight HPX resin. This is strong and durable and ensures a watertight, airtight, dust-proof, chemical resistant and corrosion proof environment for the scanner.

The case has a Vortex® valve on the front that can be used to equalize the atmospheric pressure after quick changes. It also has heavy duty wheels with stainless steel bearings, telescoping handle, and press and pull latches.

The Trimble TX 3D scanner is fitted into a high-density foam mould that protects it against impact, vibration, and shock.

Left/front side view



Item	Description
①	Press and pull latch
②	Double-layered, soft grip handle
③	In-line wheel
④	Press and pull latch (x 2)
⑤	Auto-pressure release valve
⑥	Double-layered, soft grip handle

Bottom view



Item	Description
❶	Retractable handle
❷	Lock for retractable handle

Inspecting the instrument case

If the instrument case is not in good condition, examine the items inside for visible damage. If any items are damaged, immediately notify the carrier and your Trimble sales representative.

Keep the shipping box, the instrument case, and all packing material for the carrier to inspect.

Opening the instrument case

⚠ CAUTION – Take care when removing the instrument from the case. Use proper lifting form for heavy objects.

1. Place the instrument case on the bottom side.
2. Press and pull the four latches:



3. Open the cover of the instrument case.

Items in the instrument case

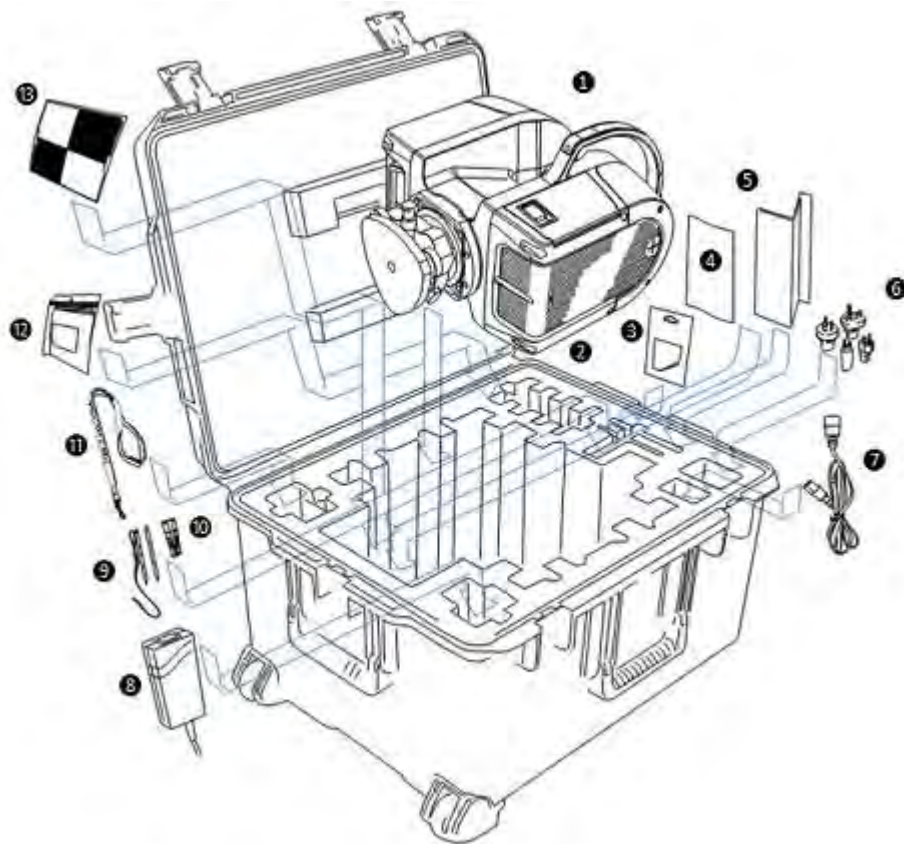

Item	Description
①	Trimble TX3D scanner and tribrach
②	Storage location for batteries (x4)
③	Set of screen protectors
④	Regulatory information
⑤	Getting Started Guide
⑥	Interchangeable adapter (x4)
⑦	Power supply cable
⑧	DC power supply
⑨	Stylus pen kit
⑩	USB flash drive
	Trimble stylus pen lanyard
	Cleaning cloth 50 pcs/bag
	Pack of 10 adhesive targets T3

Remove the instrument from the case

CAUTION – Take care when removing the instrument from the case. Use proper lifting form for heavy objects.

1. Place the instrument case on the bottom side.
2. Press and pull the four latches:



3. Open the cover of the instrument case.
4. With one hand, grasp the instrument handle, and then place the other hand on the base of the instrument as shown:



5. Lift the instrument assembly out of the case:



Lifting the instrument

To lift the instrument, there are two grips in addition to the handle:

- The upper grip is located near the top on the side opposite the main handle.
- The lower grip is located on the bottom of the scanner on the side opposite the main handle.

Use the method that you find most comfortable to lift the scanner. The options are:

- With one hand, grasp the handle, and then grasp the upper grip with the other hand:

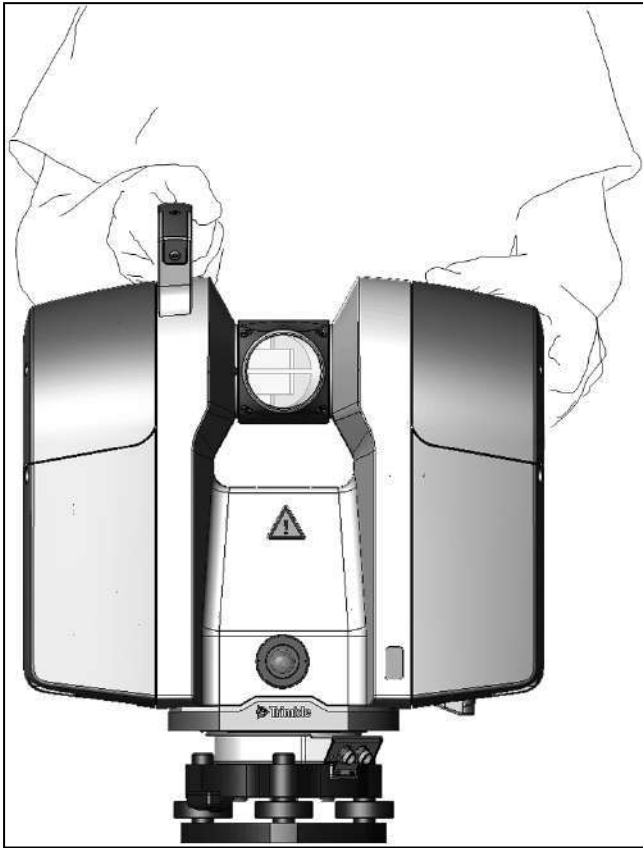

- With one hand, grasp the handle and then grasp the bottom grip with the other hand:

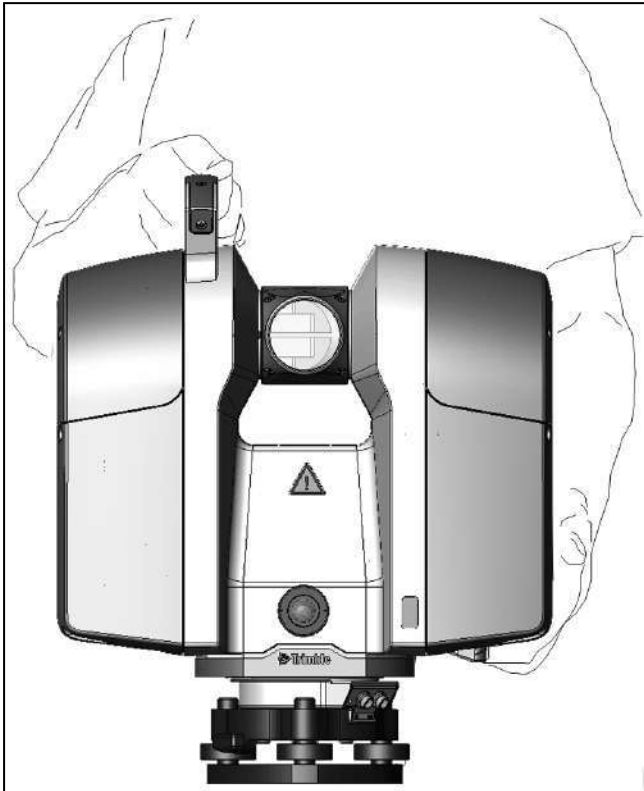

Pulling the instrument case

⚠ CAUTION – Make sure that the instrument case is securely closed before carrying out this procedure.

You can pull the instrument case using the retractable pull handle.

1. Place the instrument case stood up on its left/front side.
2. Push and hold the lock to the right to release the telescoping handle.
3. Extract the telescoping handle to its full length.
4. Hold the telescoping handle firmly and tilt the box slightly so that it leans on its wheels.

Transporting the instrument

When transporting the instrument, Trimble recommends the following:

- Use the instrument case (or preferably, the instrument case inside the original shipping box with the original foam padding blocks) to transport the instrument. The box(es) are designed to protect the instrument against shock and vibration.

Ensure that the instrument case is completely closed before moving or carrying it.

- Fix a warning label, **HANDLE WITH CARE**, to the instrument case or shipping box.

Packing the instrument case into the shipping box

1. If required, assemble the shipping box—open the box, fold in the pair of flaps along the width of the shipping box, fold in the pair of flaps along the length of the shipping box and then fasten the seam with tape or staples.
2. Place a foam pad inside the shipping box.
3. Insert the instrument case (with all the items in place) into the shipping box.
4. Place the second foam pad on top of the instrument case.
5. Close the shipping box by folding in the flaps and then fastening the seam with tape or staples.

Care and maintenance

 **WARNING** – DO NOT remove any covers from the instrument. This instrument is designed to withstand normal electromagnetic disturbance from the environment but it contains circuits that are sensitive to static electricity.

If an unauthorized person opens the instrument cover, the function of the instrument is not guaranteed and the warranty will be invalidated. The instrument is designed and tested to withstand field conditions, but like all precision instruments, it requires care and maintenance. To get the best results from the instrument, take the following steps:

- Do not subject the equipment to rough jolts or careless treatment.
 - Keep the rotating mirror lens clean. Use only lens paper or other material that is designed for cleaning optical equipment.
 - Keep the instrument protected and in an upright position, preferably in the instrument case.
 - Do not carry the instrument while the instrument is mounted on a tripod. Doing so can damage the tribrach screws.
 - Whenever manually rotating the instrument, use a slow and steady movement.
 - Do not carry the instrument by the rotating mirror. Use the handle.
 - When you need extremely precise measurements, make sure that the instrument has adapted to the surrounding temperature. Significant variations in instrument temperature can affect precision.
-

Cleaning

 **CAUTION** – DO NOT use strong detergents such as benzene or thinners on the instrument or the instrument case.

Be very careful when cleaning the instrument, especially when removing sand or dust from the mirror lens. **DO NOT** use coarse or dirty cloth or hard paper. Trimble recommends that you use anti-static lens paper, a cotton wad, or a lens brush. To clean the exterior of the instrument, use a cloth lightly dampened with water.

Removing moisture

If the instrument has been in damp weather, take the instrument indoors and remove the instrument from the instrument case. Leave the instrument to dry naturally. If condensation forms on the mirror lens, allow the moisture to evaporate naturally.

Technical support

If you have a problem and cannot find the information you need in the product documentation, contact your local dealer. Alternatively, go to the Support area of the Trimble website (www.trimble.com/support/). Select the product you need information on. Product updates, documentation, and any support issues are available for download.

Related information

Sources of related information include the following:

- Release notes – The release notes describe new features of the product, information not included in the manuals, and any changes to the manuals. They can be downloaded from the Trimble website at www.trimble.com/support/.
- Trimble training courses – Consider a training course to help you use your instrument to its fullest potential. For more information, go to the Trimble website at www.trimble.com/support/index_training.aspx.

Instrument and Accessories

- ▶ Instrument views
- ▶ Accessories

This chapter describes the instrument and its controls. Trimble recommends that you take the time to familiarize yourself with the names and locations of the controls.

Instrument views

Front of instrument

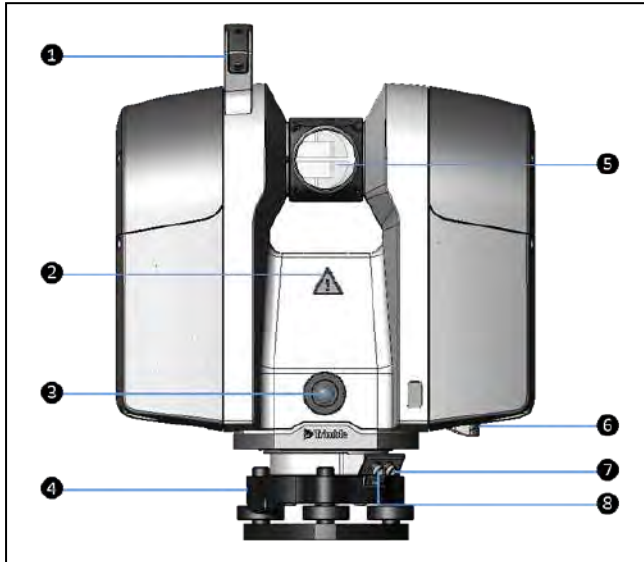

Item	Description
❶	Handle
❷	Hazard symbol label
❸	Camera
❹	Tribrach
	<i>NOTE – The Tribrach that comes with a Trimble TX8 3D scanner has an optical plummet. The tribrach that comes with a Trimble TX6 3D scanner has no optical plummet.</i>
❺	Spinning mirror
	⚠ WARNING – Stay clear of spinning mirror when in use.
❻	Bottom grip
❼	Power connector
❽	USB – Remote control connector

Back of instrument

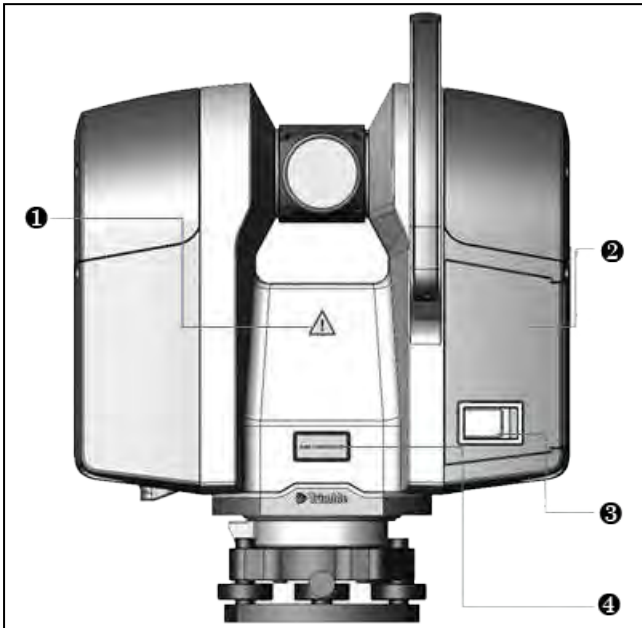

Item	Description
①	Hazard symbol label
②	Battery compartment door
③	Door latch
④	Laser warning label

Left side of instrument

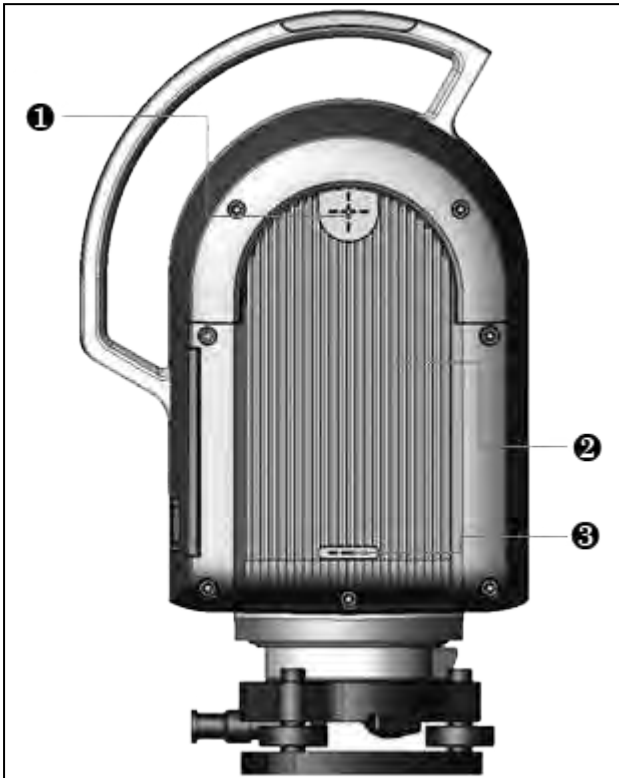

Item	Description
①	Top measurement mark
②	Instrument housing with integrated heat exchanger
③	Bottom measurement mark

Right side of instrument

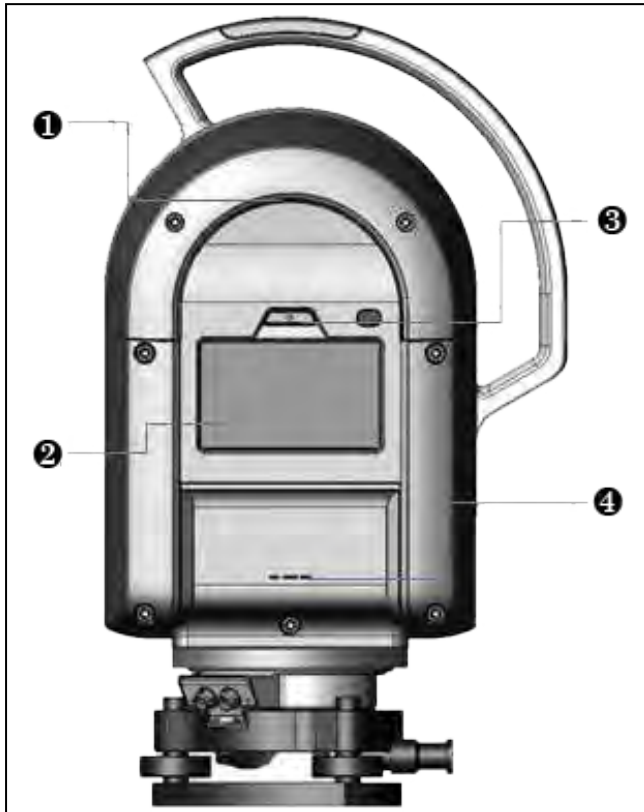

Item	Description
❶	Top grip
❷	Touch screen
❸	On/Off key
❹	Instrument height measurement mark

Battery/USB flash drive compartment

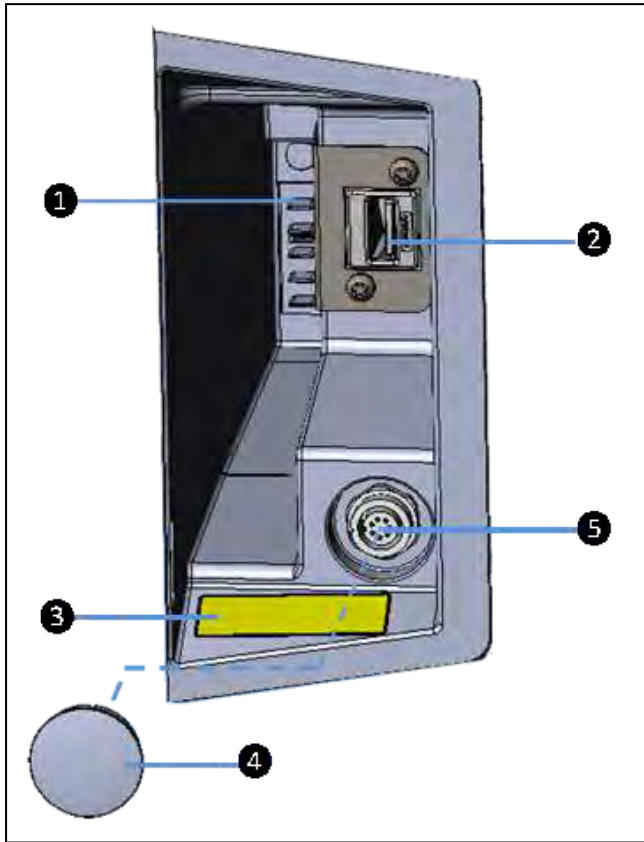

Item	Description
❶	Battery connectors
❷	USB port
❸	Warning label
❹	Rubber cap
❺	TX Auto-Start connector

Accessories

Trimble recommends that you take some time to familiarize yourself with the names and the locations of the accessories.

NOTE – Trimble reserves the right to replace the illustrated units with an alternative item, without prior warning.

External power supply kit

CAUTION – The power supply unit provided is for indoor use only. When using the instrument outdoors, please use batteries for your power requirements.

The international power supply kit includes an external power supply, a power cable, and four connectors (Europe, USA, UK, and Australia).

External power supply

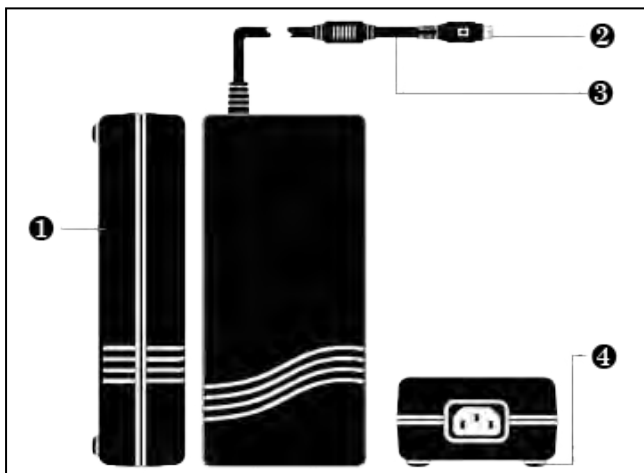

Item	Description
1	External power supply
2	4-pin connector
3	Power cable
4	Rubber foot

See also [External power supply specifications](#).

Power cable and connectors

The power cable and the four interchangeable connectors are provided in a zippered storage bag.

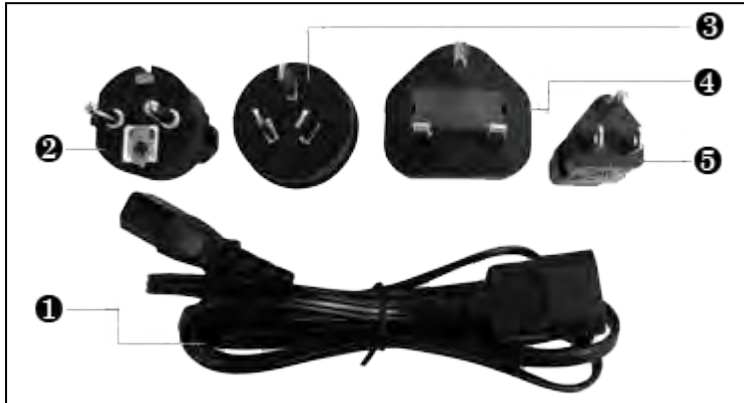

Item	Description
❶	Power cable
❷	EU connector
❸	Australia connector
❹	UK connector
❺	USA connector

⚠ CAUTION – Use only the power cable authorized by Trimble. Any malfunction or damage caused by the use of an authorized power cable to the instrument may void the instrument warranty.

USB flash drive

Use the USB flash drive that comes with the instrument or one that is commercially available. If you use a different USB flash drive, make sure that it is 64 GB or higher and formatted with FAT 32. See also [USB flash drive specifications](#).

Data acquired by your instrument is stored on the USB flash drive as well as the report resulting from a diagnostic of the instrument. The USB flash drive is also used to update the firmware in the instrument. See also [Managing the USB flash drive](#).

Battery kit

For information on the battery kit, refer to the *Trimble TX Battery Kit Getting Started Guide* that accompanies the instrument. See also [Battery kit specifications](#).

Smart battery

Before charging or using a smart battery it is important to read and understand the battery safety and environment information included in the Safety chapter on [Safety Information](#). See also [Smart battery specifications](#).



Item	Description
❶	Flap
❷	Power gauge
❸	Connectors
❹	Button

Charging a smart battery

The smart battery is supplied partially charged. Please charge the battery completely before using it for the first time. Charging takes approximately 4 hours per battery.

The two-bay charger is a smart charger. It can communicate with the battery in order to deliver the appropriate charge. Each bay is independent. The charger can charge two batteries simultaneously.

1. Place the charger on a hard, flat and level surface to ensure that there is airflow under the charger.
2. Plug the DC connector from the power supply unit into the back of the charger.
3. Plug the power supply cable to the external power supply.
4. Connect the other end of the power supply cable to a power supply network using an interchangeable connector.

5. Insert a battery into either bay ensuring that the 5-way connector is fully seated. All LEDs in the status window will provide status information and the charger automatically starts charging.

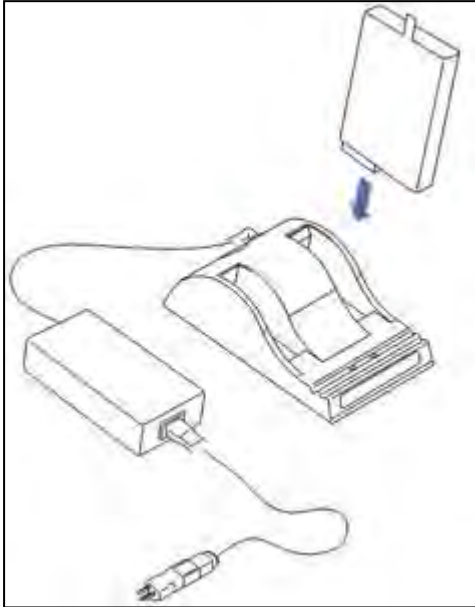





Checking the power level on a smart battery

NOTE – A battery with a poor power supply level may not be able to start the instrument (if it is switched Off) and may switch Off the instrument (if it is switched On).

To check the power supply in a smart battery, do one of the following:

- Use the integrated battery gauge. Press the button on the battery to view the four LEDs on the smart battery:
 - Each LED corresponds to a power level of 25%. If the battery is fully charged, all LEDs are lit. If it is completely discharged, all are unlit.
 - If all LEDs are flashing, the battery must be reconditioned in its charger.
- Check the level viewing the power supply icon on the touch screen with the instrument turned on. This icon indicates the following charge states:

Icon	Charge Level
	Less than 10%
	Between 25% and 50%
	Between 50% and 75%
	Between 75% and 100%
	Fully charged - 100%

Two-bay charger

The two-bay charger enables you to charge or recalibrate the fuel gauge on two batteries at the same time. See also [Two-bay charger specifications](#).

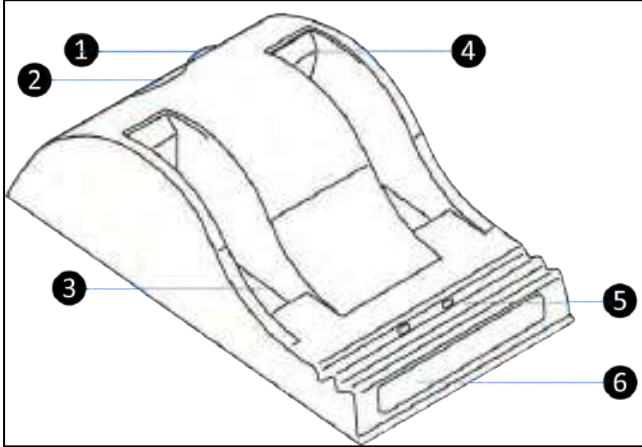

Item	Description
❶	DC connector
❷	Fan outlet
❸	Battery bay
❹	Spacer (already inserted)
❺	Recalibration button
❻	Status window
Not shown	External power supply

Connecting to the main power supply

1. Place the charger on a flat surface near an electrical outlet to ensure airflow under the charger.
2. Plug the AC/DC converter cable into the DC input connector on the rear of the charger.

3. Plug the power cable into the AC/DC adapter and into an electrical outlet via an interchangeable connector. All the LEDs will flash momentarily to let you know that power is present:

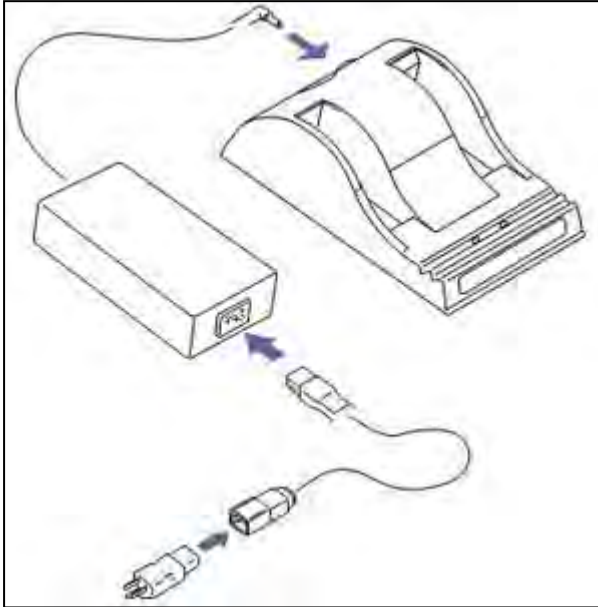

LED behaviors

There are two LED indicators behind the status window, one for each battery bay. Both indicate battery status.

If the icon is ...	then ...
✱ green, flashing	the battery is charging.
● green, solid	the battery is fully charged.
✱ blue, flashing	the battery is in calibration mode.
● blue, solid	the battery fuel gauge has been calibrated.
✱ red, flashing	the battery fuel gauge is in need of recalibration.
● red, solid	there is an error.

Tribrach

The tribrach that comes with the instrument is equipped with a bull's-eye bubble for leveling and a built-in optical plummet for precise setting up over a survey point. See also [Tribrach specifications](#).

The instrument is also equipped with an internal electronic level and dual-axis compensator. See [Leveling](#).

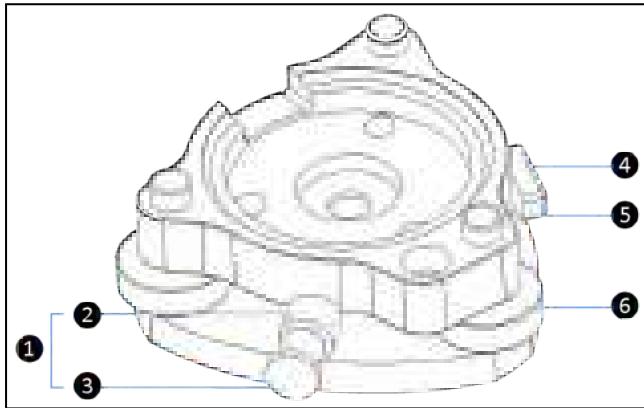

Item	Description
❶	Eye piece
❷	Cross-hair ring
❸	Focusing ring
❹	Clamping arm
❺	Circular bubble level
❻	Foot screw (x3)

NOTE – The Tribrach that comes with a Trimble TX8 3D scanner has an optical plummet, while the one with a Trimble TX6 3D scanner has none.

Micro fiber lens cleaning cloth

A micro-fiber lens cleaning cloth is included. See [Micro fiber lens cleaning cloth specifications](#).

Stylus pen kit

The stylus pen kit is composed of two styluses and one tether.



TX USB external cable

The Trimble TX USB External Cable is a cable of 2.8 meters.

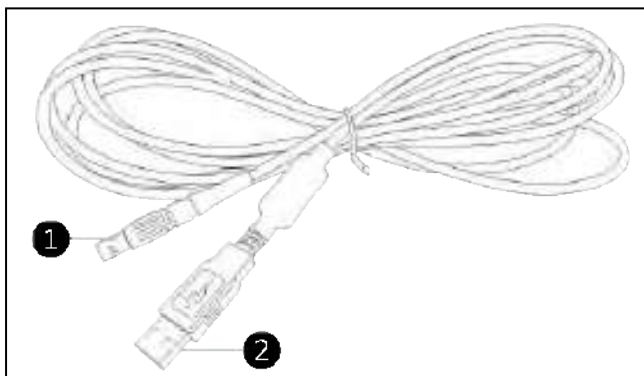

Item	Description
①	LEMO Connector
②	USB Connector

It enables you to connect your Trimble TX 3D scanner to a remote device that should have the following requirements.

Remove device system requirements

Remote Device	Microsoft Windows™ PC or tablet running Windows 7 Home Premium or later
Cable	Part Number 23704034 - TX USB Cable 2.8 Meters Tablets with MicroUSB ports require an OTG to USB adapter
Drivers	LAN 9500 drivers for Windows x86 and x64 Download Trimble TX LAN 9500 Drivers
VNC Client	RealVNC Viewer for Windows x86 and x64 Download Trimble TX RealVNC Viewer

NOTE – The Trimble TX USB external cable is an optional cable that must be purchased separately. Trimble reserves the right to replace the illustrated unit with an alternative item, without prior warning.

NOTE – Microsoft Windows™ RT or Windows™ Mobile/Phone OS is not supported.

TX Auto-Start

The TX Auto-Start enables to by-pass the use of the power supply button. It sets a delay of about 10 seconds between the moment the instrument is powered on by the power supply unit, and the moment the instrument starts scanning. This is useful for monitoring at distance the instrument.

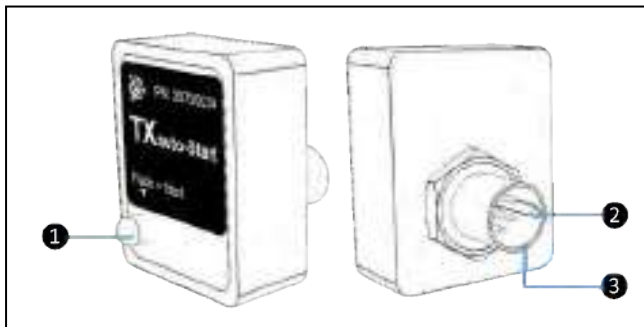

Item	Description
①	LED
②	DIN Connector
③	Notch

Setup

- ▶ Setting up the tripod
- ▶ Setting up the instrument
- ▶ Settling down the instrument on the tribrach
- ▶ USB flash drive
- ▶ Powering the instrument
- ▶ Turning the instrument on and off
- ▶ Connecting the instrument to a remote device
- ▶ Plugging the TX Auto-Start into the instrument
- ▶ Changing the default settings
- ▶ Measuring the instrument heights

Take the instrument case and accessories where you want collect data. You are now ready to set up the tripod and prepare the instrument for scanning.

If you want to use the instrument in a survey workflow, you will need a control point, which is required for setting up the instrument.

This control point becomes the first site point for data collection. Be sure you know its coordinates and identifier. Set up the instrument on the tripod over the control point and then visually locate a second point called the backsight point. The direction from the control point to the backsight point will indicate where you need to direct the instrument.

Setting up the tripod

1. Spread the three legs of the tripod.
2. Unscrew the screw lock at the bottom of each leg.
3. Extend the three legs as far as required.
4. Tighten the screw lock at the bottom of each leg.

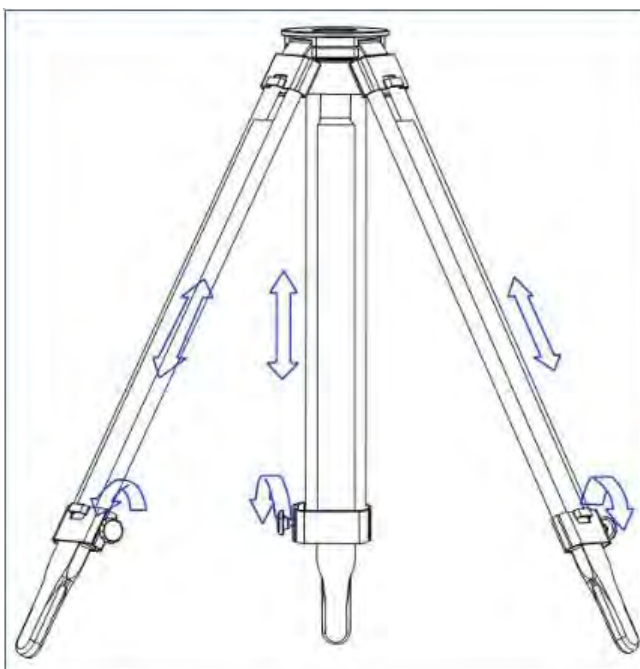

NOTE – The three legs must be set wide enough apart to increase the stability of the setup. If it is not possible to set the legs wide apart, consider lowering the tripod. However, the height of the tripod must allow the instrument to be effectively mounted.

5. Position the tripod over the control point on flat and stable ground where possible.
6. Visually check that the tripod plate is as horizontal as possible.

CAUTION – To avoid the tripod tipping over and damaging the instrument, ensure that the ground is stable when installing the tripod. Do not push the legs into the ground because you may need to adjust the tripod position.

Setting up the tribrach

Your instrument is supplied with a tribrach mounted on it. Remove it from the instrument before performing the steps below.

1. Remove the rubber cover from the tripod head.
2. Stand a few paces from the tripod.

3. Visually check that the tripod is set up so that the tripod plate is as horizontal as possible.
4. Place the tribrach in a central position on the plate of the tripod.

NOTE – When placing the tribrach on the tripod plate, ensure that you align the foot screws with the tripod legs.

5. Secure the tribrach with the central fixing screw.

Leveling the tribrach

1. Turn two of the foot screws together in opposite directions. The bubble should move from right to left and vice versa.

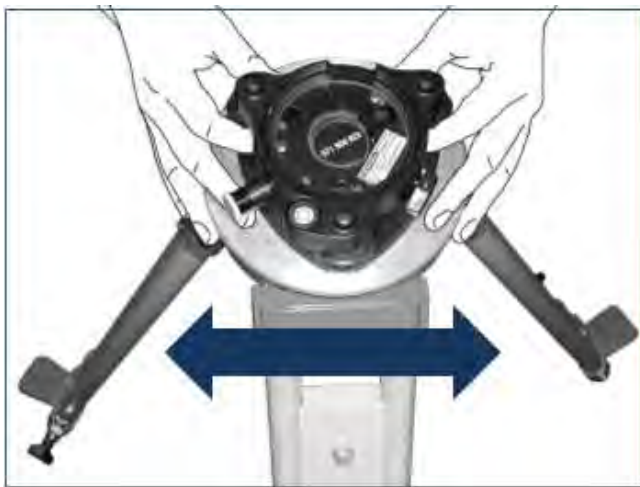

2. Move the bubble into the center of the circular bubble level.
3. Turn the third foot screw. The bubble should move from forward to backward and vice versa.
4. Move the bubble into the center of the circular bubble level.



Centering over a known point

If the tribrach supplied with your instrument has with an optical plummet, perform the steps below. Otherwise, skip the steps.

NOTE – The tribrach that comes with a Trimble TX8 instrument has an optical plummet, while the one with a Trimble TX6 instrument has none.

1. Look through the optical plummet eyepiece on the tribrach.

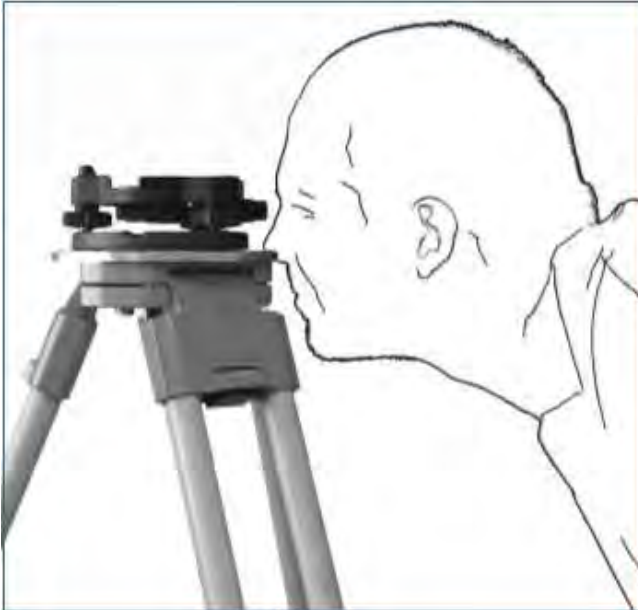

2. Rotate the cross-hairs ring on the eyepiece until the cross-hairs appear clear, then rotate the focusing ring on the eyepiece to focus on the control point.



3. Look again through the optical plummet eyepiece. If the cross-hairs are not exactly over the control point on the ground, do one of the following:

- Move the tripod to align the cross-hairs with the control point.
 - Lightly unscrew the central fixing screw below the tripod to move the tribrach. Look through the eyepiece and align the cross-hairs with the control point and then secure the fixing screw.
 - Lightly unscrew the screw locks on the tripod, extend or retract the three legs to align the cross-hairs with the control point and then secure the screw locks.
4. Stand a few paces from the tripod and visually check that the tripod head is still horizontal.
 5. Visually check again that the bubble is still in the center of the circular bubble control level.

Setting up the instrument

Set up your instrument on the tripod using the following steps.

1. Place the instrument over the tribrach.
2. Align the instrument studs with the foot screws of the tribrach:

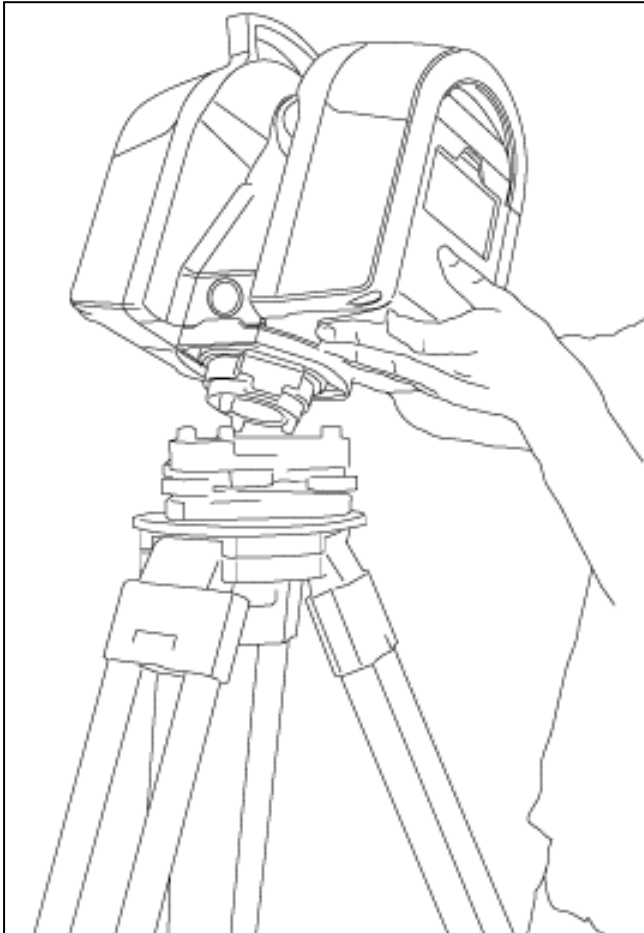

3. Firmly insert the instrument into the tribrach.
4. Secure the instrument with the tribrach clamping arm.

Settling down the instrument on the tribrach

NOTE – In some cases, you may need to manually move the instrument slightly in the tribrach from left to right and vice versa as illustrated in order for the scanner to settle completely in the tribrach’s locking system so it is stable before tightening the clamping arm on the tribrach.

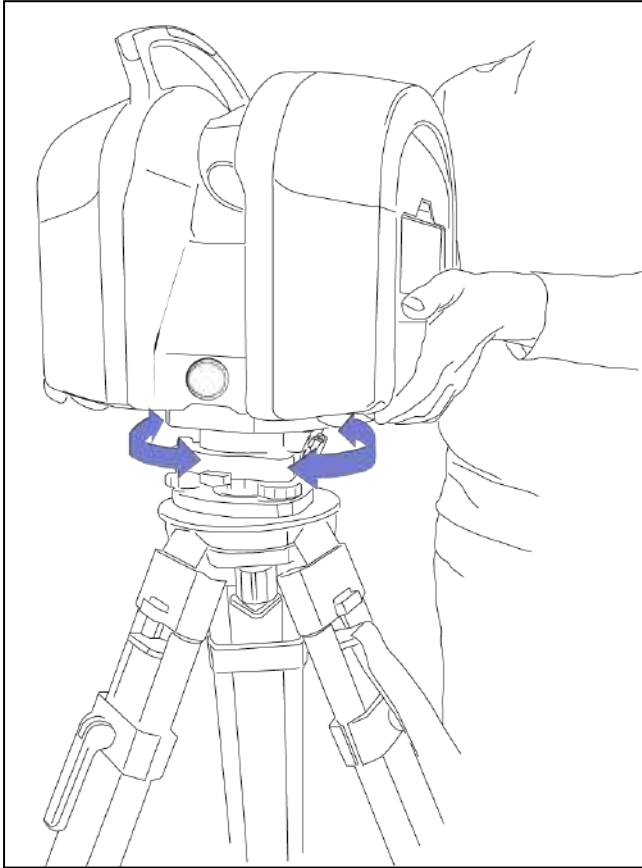

USB flash drive

The USB flash drive needs to be inserted in the instrument for data storage. You can use the USB flash drive that comes with your instrument or one that is commercially available.

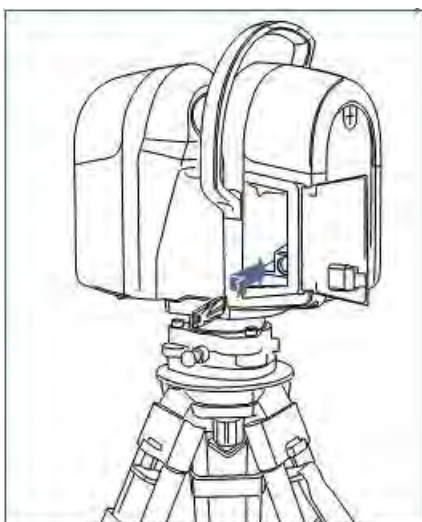

Inserting the USB flash drive

1. Release the latch of the battery compartment door.
2. Open the battery compartment door.
3. Insert the USB flash drive into the USB slot:



4. Close the battery compartment door.

Once the USB flash drive has been inserted into the USB port, and once the instrument is switched on, the following icons appear on the touch screen:

If the icon ...	it indicates that the USB flash drive ...
 is red and blinking, with 0 beside it	is full, and needs to be replaced. <i>NOTE – A dialog appears if the user attempts to perform a scan despite of the full disk indication.</i>
 is red and blinking	is missing, or is being formatted.
USB icon is not present, but only a number displayed	has been inserted into the instrument. The number of scans the USB flash drive can store changes when you change the scan settings. See Scan parameters .

NOTE – If you insert a brand new or empty USB drive into an instrument, a folder containing a Trimble RealWorks project file (*.rwp extension) is created under the root of the drive. Both the

folder and the project file takes the name of:

-Project 001, if no project has been initially created.

-The last project with the value of 001 if the name ends by a letter, or with an increment if it ends by a number.

If the USB flash contains some projects, the last project is loaded.

 **CAUTION** – DO NOT use a computer running Windows for formatting your USB flash drive. Due to the size recommended by Trimble, a minimum of 64 GB, the file system may not be compatible with the file system in use in the instrument. Please, use the formatting feature available in your instrument for formatting your USB flash drive.

Removing the USB flash drive

 **CAUTION** – DO NOT remove the USB flash drive from the instrument while it is scanning, running a firmware update, or processing a diagnostic test.

1. Release the latch of the battery compartment door.
2. Open the battery compartment door.
3. Remove the USB flash drive from the USB slot.
4. Close the battery compartment door.

Powering the instrument

You can use a battery or an external power supply to power the instrument. Both options are provided.

If you insert a battery into the instrument while it is connected to an external power unit, the battery will be used as the primary power supply (if the battery is fully charged). When the battery charge level drops to 60%, the external power supply takes over.

Using an external power supply

⚠ CAUTION – Remove the instrument from the tripod prior to transport. Do not move the instrument while connecting or disconnecting the external power supply.

1. Remove the rubber cap from the 12 V power connector that is on the front side of the instrument.
2. Align the red dot at the LEMO connector of the power supply cable with the red mark at the 12 V power supply connector.
3. Firmly insert the LEMO connector into the 12 V power supply connector.
4. Plug the power supply cable to the external power supply.
5. Connect the other end of the power supply cable to a power supply network using an interchangeable connector:

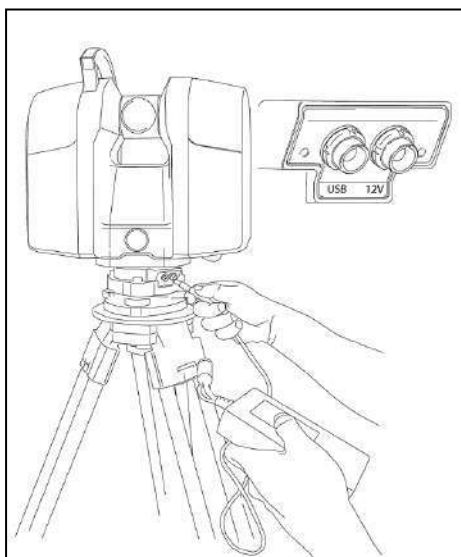

NOTE – Use the interchangeable adapter suited to your power supply network.

NOTE – Use a circuit-breaker (not supplied) between the external power supply and the power supply network to protect your equipment against voltage fluctuations.

NOTE – Once the instrument is turned on, on the touch screen either the Battery icon appears if there is fully charged battery installed, or the Power Supply icon appears indicating that the external power supply is being used.

NOTE – For powering the instrument, we recommend you to use a battery in addition to the power supply unit. This way, when there is a power cut in the power supply network, the battery can take over to power the instrument.

Inserting a battery

The smart battery fits into the battery compartment on the back of the instrument. It can be easily removed and replaced.

1. Ensure that the instrument is turned off.
2. Release the latch of the battery compartment door.
3. Open the battery compartment door.
4. Insert the battery into the battery compartment with the battery connectors positioned towards the bottom of the instrument:

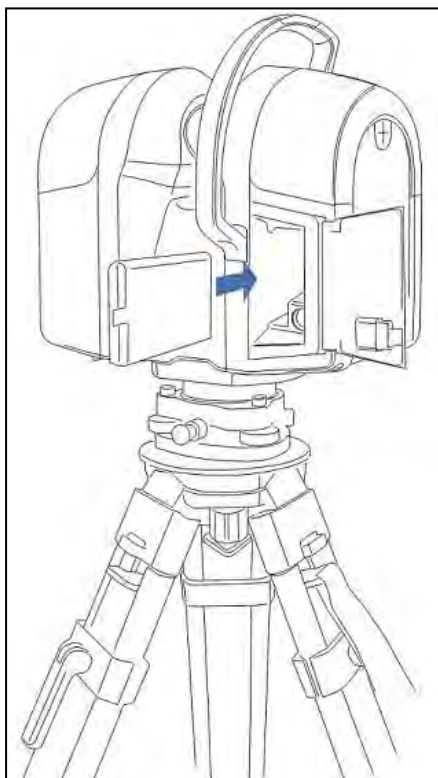

5. Close the battery compartment door.

NOTE – Once the instrument is switched on, the power supply icon on the touch screen indicates that the instrument is powered by battery.

Removing a battery

⚠ CAUTION – DO NOT remove the battery from the instrument while it is scanning, running a firmware update, or processing a diagnostic test.

1. Ensure that the instrument is turned off.
2. Release the latch of the battery compartment door.
3. Open the battery flap.
4. Remove the battery from its slot. If required, you can use the tab to help you do this:

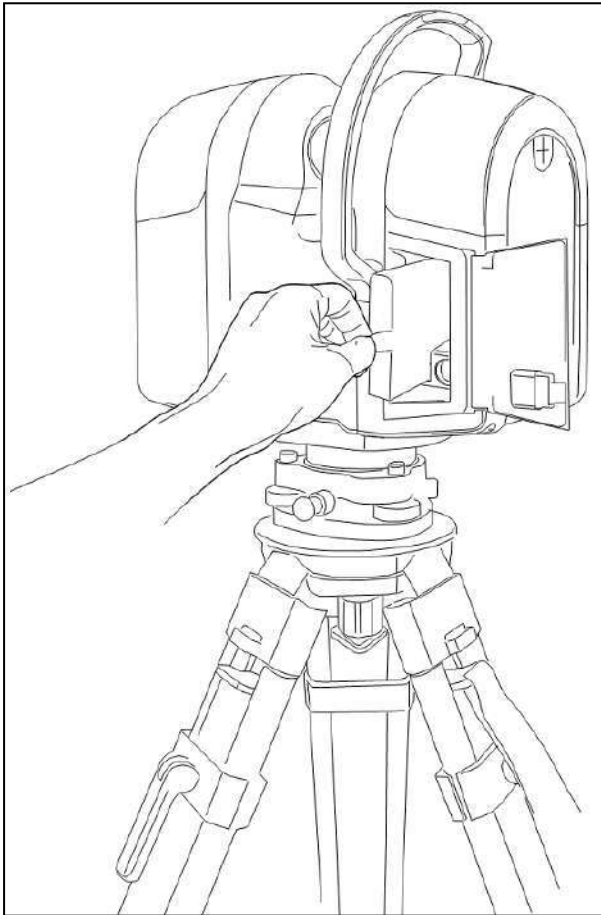

5. Close the battery compartment door.

Turning the instrument on and off

Turning on the instrument

To turn on the instrument, press and hold the On/Off key for at least three seconds.

The LED on the On/Off key first lights up accompanied by a beep indicating that the instrument is starting up.

After the instrument has started, the LED stops blinking and stays illuminated in green. The main menu appears on the touch screen. See [Software](#).



NOTE – To ensure the best performance it is important to first let the instrument warm up. To do this, perform a Level 2 scan in the environment where the scanning will take place. See [Choosing a scan mode](#).

Turning off the instrument

To turn off the instrument, press and hold down the On/Off key.

Connecting the instrument to a remote device

You can connect your TX instrument to a remote device over the WLAN or with a USB cable.

Connecting to the instrument over the WLAN

Connect to the TX instrument over the WLAN using a Trimble tablet or other Windows tablet, Apple iPad or iPhone, or Android tablet or phone. RealVNC Viewer is recommended for the VNC client software for the mobile device.

1. Turn on your TX instrument, by pressing and holding the On/Off key for at least three seconds.
2. Enable the Wireless Connection (see [Setting a Wireless Connection](#)).
3. Turn on your remote device, for example a Trimble Yuma tablet.
4. Click the Network icon in the notification area of your desktop. All available connections are listed in a panel:



5. Select the instrument you want to connect to.

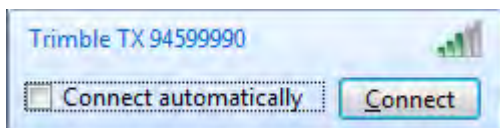

6. If required, check the **Connect Automatically** option and click **Connect**. The **Connect a Network** dialog opens.

- Enter the "0123456789" value in the **Security Key** field.

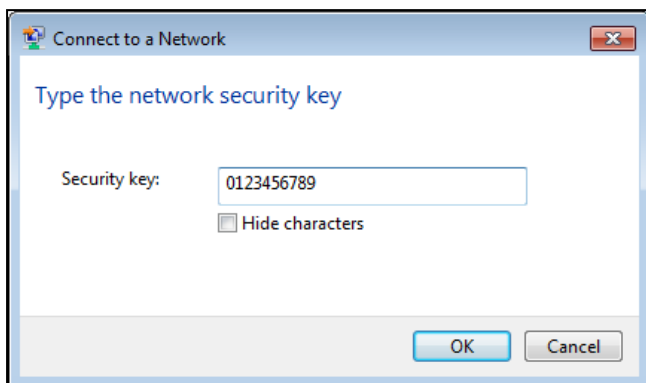

NOTE – To change the network security key, see the section [Changing the Connection key](#).

- Click **OK**. The connection to the instrument is then processed.

If you experience connection problems, try changing the WI-FI channel. See the section [Changing the WI-FI Channel](#).

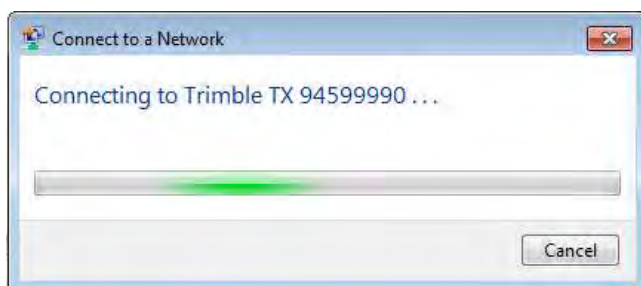

- Use the link below to download the VNC Viewer for your mobile device. This link provides access to Windows 32-bit or 64-bit executable, and IOS and Android App Stores to download the RealVNC Viewer.

[RealVNC Viewer](#)

- Run the VNC Viewer on your mobile device.
- Configure the VNC Server with the IP address of 192.168.43.1 as shown and then click **Connect**.

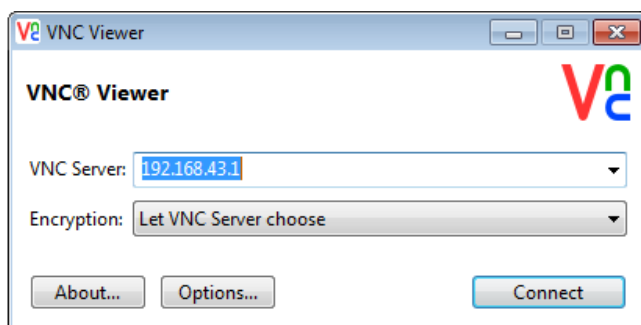

12. The VNC Viewer – Encryption dialog opens and warns you that the connection will not be encrypted. Click **Continue**.



The Trimble TX user interface will display on your remote device for remote operation of the instrument.

Connecting to the instrument with a TX series cable

1. Remove the rubber cap from the USB connector at the base of the instrument.
2. Align the red dot on the LEMO connector of the TX USB cable with the red mark on the TX USB connector.
3. Firmly insert the LEMO connector into the TX USB connector.

4. Insert the USB connector of the TX USB cable into the USB connector on the Windows PC or tablet, for example, a Trimble Yuma tablet (illustrated below):

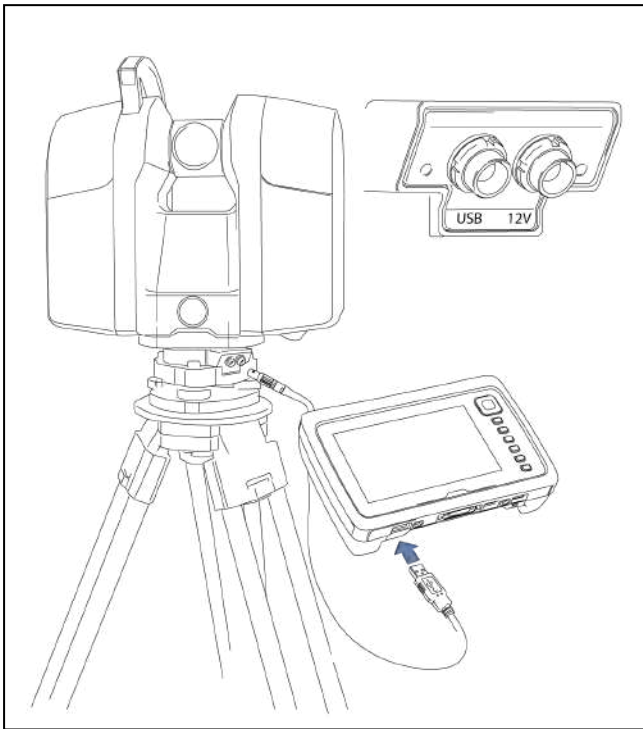

5. Turn on the instrument. If your remote device is connected to the Internet, the appropriate LAN9500 driver should automatically download and install:

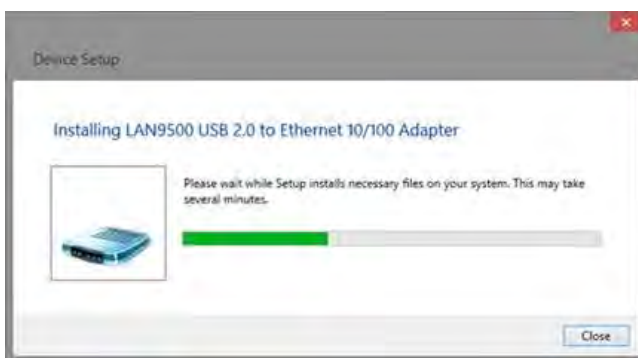

6. If you do not have Internet access, use the link below to download the LAN9500 executable and manually install the driver.
[LAN 9500 drivers](#)
7. Use the link below to download the VNC Viewer and copy either the 32-bit or 64-bit version to your device.
[RealVNC Viewer](#)
8. Double-click the VNC Viewer executable to run the program.

9. Configure the VNC Server with the IP address of 192.168.42.1 as shown and then click Connect:

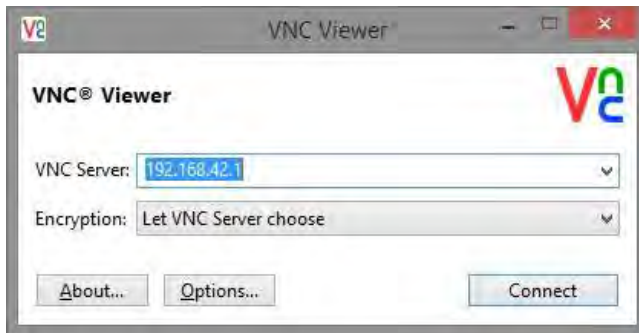

The Trimble TX user interface will display on your remote device for remote operation of the instrument.

***NOTE** – Remote devices with Micro USB ports require an OTG-to-USB adapter.*

Plugging the TX Auto-Start into the instrument

1. Ensure that the instrument is turned off.
2. Release the latch of the battery compartment door.
3. Open the battery compartment door.
4. Remove the rubber cap from the connector, inside the battery compartment. If required, use a slot screwdriver.
5. Put face-to-face the TX Auto-Start and the connector. The LED on the front side of the Auto-Start should be facing down, as illustrated hereafter. This way that the notch on the TX Auto-Start and the notch on the connector are aligned.

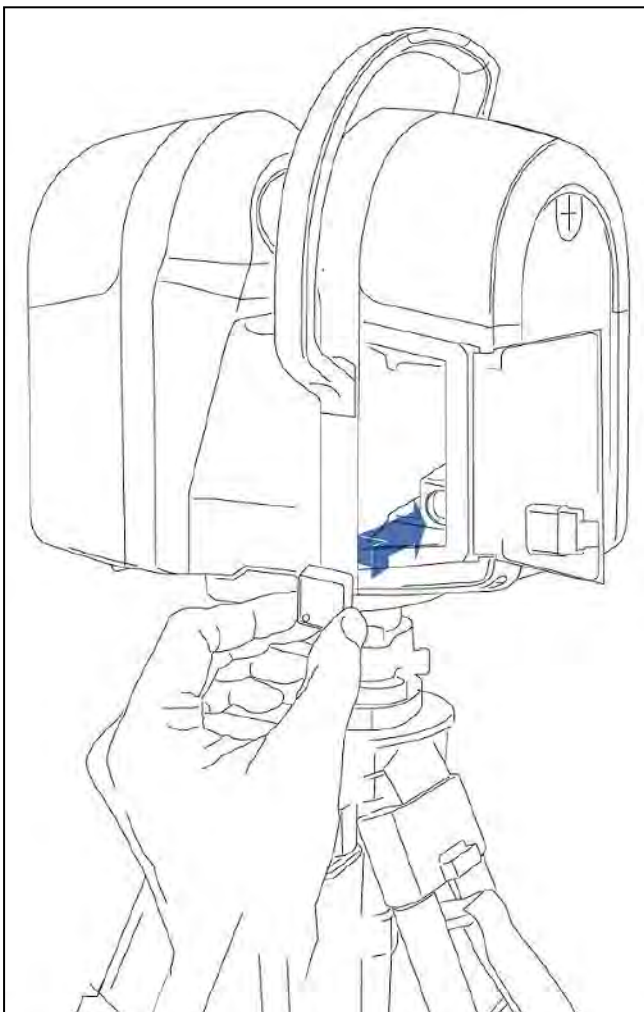

6. Push the TX Auto-Start into the connector.
7. Close the battery compartment door.
8. Power the instrument with the power supply unit.

Changing the default settings

The instrument has factory default settings for date, time, and unit of measurements. Before using the instrument, you should change these to meet your requirements. See [Setting the date and time](#) and [Selecting the measurement units](#).

Measuring the instrument heights

NOTE – Measuring the instrument height is only available on the Trimble TX8 because the Trimble TX6 does not support survey workflow.

The Instrument Height (IH), also called True Vertical, is the distance between the Known Point used during instrument setup and the centre of the mirror. As this centre is not accessible, two measurement marks are on the left side of the instrument and one on its right side.

The Top Mark ❶ corresponds to the Trunnion Axis of the instrument. The Bottom Mark ❷ is 0.184 m below the Top Mark. The Bottom Mark is at a distance of 0.1675 m from the center of the instrument.

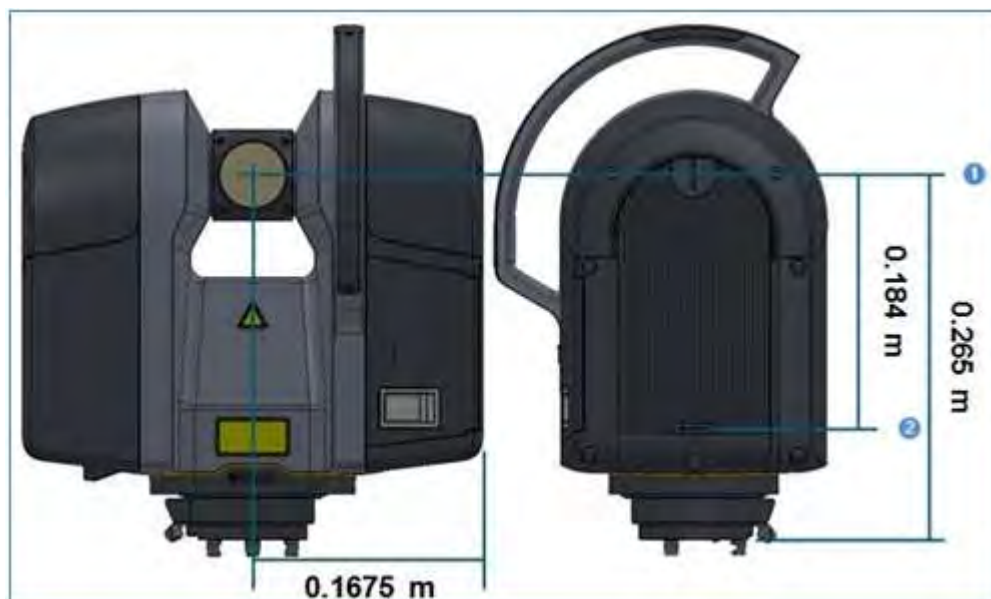

Measuring the ground-to-bottom mark distance

Measure the distance which separates the Known Point on the ground to the Bottom Mark on the side of the instrument. This measured distance will be called Hm (or Bottom Mark). To obtain the True Vertical value, please use the formula given hereafter.

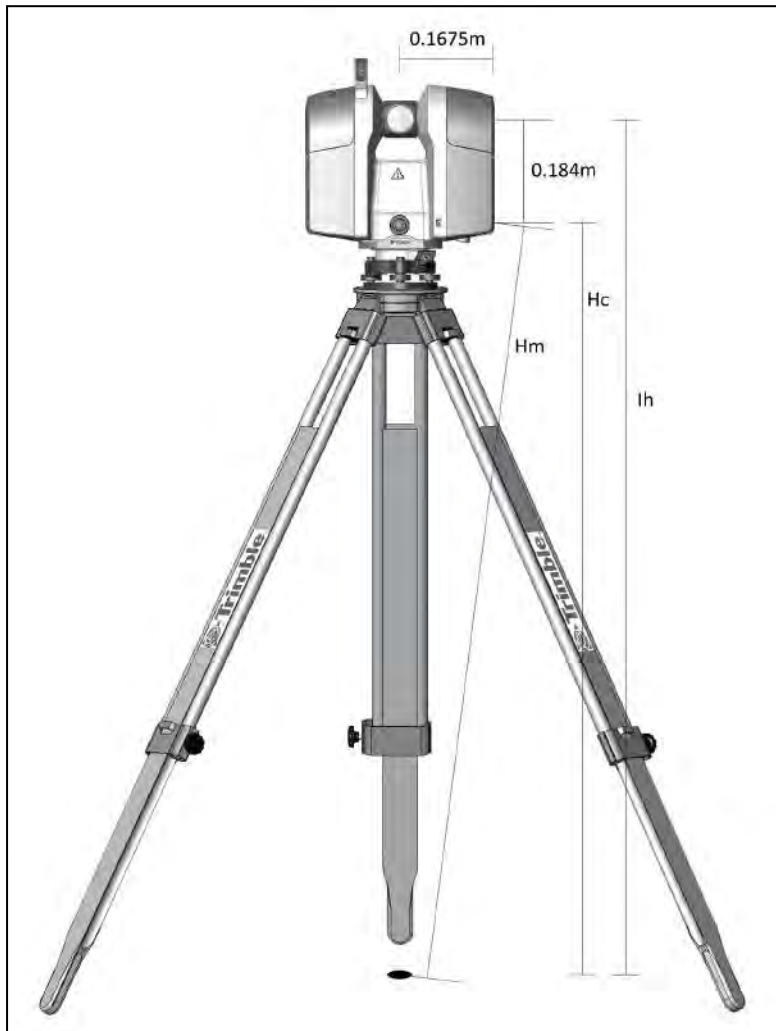

Computing the instrument height (IH)

To calculate the Instrument Height (IH), please insert the measured distance (Hm) into the formula below:

$$Ih = 0.184 + \sqrt{Hm^2 - 0.1675^2}$$

The Hm distance is corrected to obtain a vertical measurement to the Bottom Mark. This vertical measurement is called (Hc). The distance from the Bottom Mark to the Top Mark is added to the (Hc) to obtain the Instrument Height from the Known Point to the Trunnion axis (Ih).

Software



- ▶ Touch screen
- ▶ Projects
- ▶ Leveling
- ▶ Scan parameters
- ▶ Settings

This chapter explains how to change the settings in the software to suit your needs.

Touch screen

The touch screen is a resistive screen. You can use either your finger, or the stylus that comes with the instrument to access the software settings and to perform scans.



Item	Description	Item	Description
1	Trimble icon	7	"Blank" indicates that the Color Acquisition feature is disabled
2	Current project		Color: ON indicates that the Color Acquisition feature is enabled in Standard mode
3	Number of scans that can be stored in the USB flash drive using the current scan settings		Color: ON – HDR indicates that the Color Acquisition feature is enabled in HDR mode
4	Wi-Fi signal (if the WLAN option is enabled)		Exposure: Fixed , changed to "Color: ON" (or "Color: ON – HDR") and vice versa, indicates that the Fixed Exposure feature is enabled
5	 Approximates the remaining battery power (if a battery is used)  Indicates that the power supply unit is used	8	Current scanning settings
6	High contrast icon		

When powering the instrument with the USB flash drive missing, a dialog appears and prompts you to insert a USB flash drive. The USB Flash Drive icon flashes red. The message **No USB Flash Drive** appears next to the Trimble icon and there is no station name in the "Station" line.

Once an USB flash drive has been inserted into the USB port of the instrument, the dialog closes. The message **NO USB Flash Drive** disappears. The red and flashing USB Flash Drive icon stops flashing. It becomes white and displays the number of scans (based on the current settings) that it can store.

NOTE – The dialog only appears when the instrument starts. When unplugging the USB flash drive from the instrument while it is already powered on, only the USB flash drive icon flashes red and the message **NO USB Flash Drive** appears next to the Trimble icon.

NOTE – If the USB flash drive is missing, some features of the software are disabled. Selecting these features causes the screen to re-appear.

Projects

When you insert a new or an empty USB flash drive into the instrument, a new project is automatically created. By default it is named "Project XXX", where XXX starts at 001 and increments by one digit each time a new project is created.

If there is no project available on the USB flash drive when turning on the instrument, a new empty project is created using the name of the last scanned project and starting with "Station 001". If there is a project stored on the USB flash drive, the last modified project is automatically loaded.

A project folder named "Project XXX" is created under the root of the USB flash drive. Under that folder, a RealWorks project file with an RWP file extension is also created.

1. From the main menu, tap . The projects dialog appears:

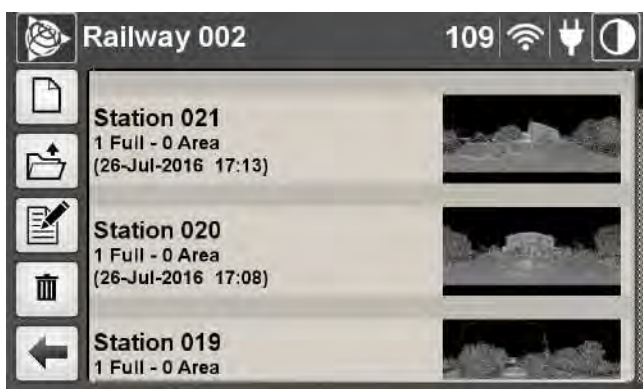

2. In this dialog, you can:
 - Manage projects. See [Managing projects](#).
 - Manage stations. See [Managing stations](#).
 - Manage scans. See [Managing scans](#).

NOTE – If there is no USB flash drive in the instrument when tapping the **Projects** button , a dialog appears and prompts you to insert one.

Managing projects

Projects can be created, opened, edited, and deleted.

Creating a project

1. From the **Projects** menu, tap . The **Create new project** dialog appears:



2. In the **New Project Name** panel, tap **Change**. The **Project name** dialog appears. Enter a name for the project and then tap **OK**.

The name for the next project is the current (or last) project with an increment. This increment can be either a number or a letter. For example, if the last character for the current project is 8, it will be then 9. If it is an S, it will be then a T, and so on. The name can be composed of letters, numbers, and characters. Some characters are forbidden, which are dimmed on the keyboard.

3. In the **Operator Name** panel, tap **Change**. The **Operator name** dialog appears. Enter the name of the operator and then tap **OK**.

If an operator name has been entered for the current project, this name is then used for the next project and it is displayed in the panel. If there is no operator name, the **Operator Name** panel is blank. The name can be composed of letters, numbers, and characters. The **Operator Name** is reset to blank when you reset your Personal Settings.

4. Tap **Save**. The **Create New Project** dialog disappears.

A project folder named Project XXX is created under the root of the USB flash drive. Under that folder, a RealWorks project file with an RWP file extension is also created.

Opening a project

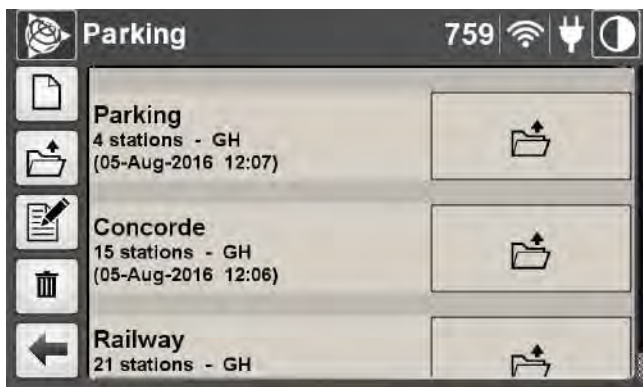

1. From the **Projects** menu, tap . All projects are listed in order of creation:



2. For each project, you can view the following information:
 - Project name.
 - Number of stations – Operator name.
 - Day/Month/Year and time of creation between parenthesis.
3. Tap  next to the project that you want to open. All stations in the project are listed. See [Managing stations](#).

CAUTION – Be careful to not open and save a project in the Trimble RealWorks software, directly from the USB drive. If doing this, Realworks will overwrite the project and, you will no longer be able to open it on the instrument, and it will disappear from the project list when you tap the Open Projects icon .

Deleting a project

1. From the **Projects** menu, tap . The icon turns yellow  and a Delete icon appears next to each project except for the current open project. You cannot delete an open project.
2. Tap  next to the project that you want to delete. A dialog prompts you to confirm the operation.
3. Tap **Yes**.

CAUTION – Deleting a project deletes the related project file (with an RWP extension) and folder (with an RWI extension) as well as all scans in the project.

Editing a project

1. From the **Projects** menu, tap . The **Edit current project** dialog appears:



2. In this dialog, you can:
 - Rename the current project.
 - Change the operator name.
3. Tap **Save**. The **Edit Current Project** dialog closes.

To rename the current project:

1. In the **Current Project Name** panel, tap **Change**. An on-screen keyboard appears with the current name highlighted.
2. Enter another name and then tap **OK**. The **Edit current project** dialog appears.
3. Tap **Save**.

The Trimble RealWorks project file (with an RWP extension), the project folder (with an RWI extension), and the folder which contains both of the files are also renamed. If there is a TZF format file in the RWI folder, the project name (of the file) is also renamed.

To change the name of the operator in the current project:

1. In the **Operator name** panel, tap **Change**. An on-screen keyboard appears with the current name highlighted.
2. Enter another name and then tap **OK**. The **Edit current project** dialog appears.
3. Tap **Save**.

NOTE – The Operator name is reset to blank when you reset your Personal settings (see [Personal settings](#)).

NOTE – If you desire to edit a project other than the current project, you first have to open it.

Managing stations

After tapping the Projects icon, the current project opens automatically. If the project is empty, the message **This project is empty** appears. If it is not, all stations for that current project are listed:

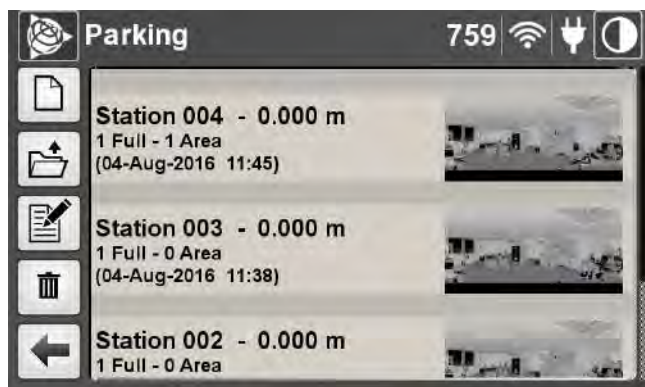

Stations are listed in order of creation. A station is simply a container. For each station, verify the following information:

- The instrument height.
- The number of Full scans.
- The number of Area scans.
- The Day/Month/Year and time it was created.
- A thumbnail image.

Creating a station

Each time a scan is performed, a new station is automatically created. By default, each station is named "Station XXX", where XXX starts at 001 and increments by one digit each time a new station is created. You cannot manually name a newly created station; you must use the default one.

The number between the parenthesis next to the USB flash drive icon on the main menu decreases each time a new station or scan is created. At the same time, a TZF format file is created and placed in the RealWorks project folder (named Project XXX.rwi). The TZF format file is: Project XXX_Station XXX_Scan XX.tzf. If the current project is empty (no stations), the RealWorks project folder is automatically created.

In addition to the created TZF format file, an image file with the exact same name and the TCF extension, is also created, if the Color Acquisition option has been initially enabled. See [Setting the color acquisition mode](#).

The current station name is shown in the title bar:



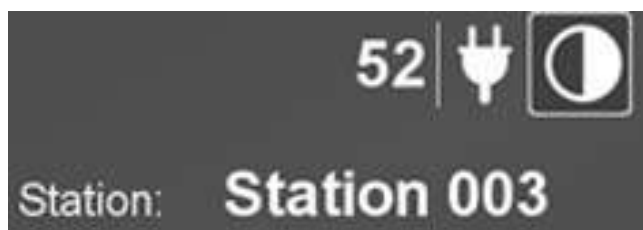

The name on the main menu is the name of a new station:



Deleting a station

Deleting a station deletes all the scans associated with that station.

1. Tap . A Delete icon appears next to each station, in place of the thumbnail.
2. Tap  next to the station that you want to delete. A dialog appears and prompts you to confirm the deletion. Tap **OK**.

 **CAUTION** – You may see that the station is removed from the list on the touch screen. The "Project XXX_Station XXX_Scan XX.TZF" file(s) that is related to the deleted station is also removed from the RealWorks project folder (with an RWI extension) on the USB flash drive. Wait a while, otherwise, the file(s) will not be deleted from the USB flash drive.

Managing scans

When you tap the station's thumbnail, all scans for that station are listed. Scans are listed in order of creation. For each scan, you can view the following information:

- Type: "Full" or "Area".
- Mode of acquisition: Preview, Level 1, Level 2, Level 3, or Extended (if the Extended option is installed). See [Choosing a scan mode](#).
- Mode of precision: One Pass or HP – 4 Passes. See [Choosing a scan precision](#).
- Instrument Height value.
- The Day/Month/Year and time of creation.
- The thumbnail preview of the image to be scanned.

NOTE – Be aware that when using a Trimble TX6 instrument, the Extended mode of acquisition, the Precision mode, and the Instrument Height value are not available.

NOTE – If the Color Acquisition option has been chosen (see [Setting the color acquisition mode](#)), the resulting thumbnail image is flagged as illustrated below.

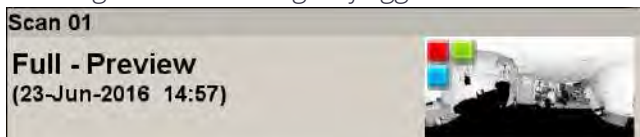

Creating a scan

By default, a scan is a 360° acquisition of 3D coordinate data, also known as a "Full scan". If you want to acquire data on a smaller area, this is called an "Area scan".

Each scan is named "Scan XX" where XX is its order. XX starts at 01 and increments by one digit for each new scan. You cannot give a name to the newly created scan other than the default one. For each scan, a TZF format file is created and placed in the RealWorks' RWI folder. It is named: Project XXX_Station XXX_Scan XX.

NOTE – The current scan name does not appear on the title bar as for a project or a station.

CAUTION – When moving to a new station you must return to the **Home** menu and start the scan from there. All scans performed from the **Scan Display** menu are associated with that station.

Acquiring a full scan

1. From the main menu (or in the **Scanning** panel of the **Leveling** dialog), tap . The instrument performs an initialization. It rotates around its vertical axis to find its zero position.

The initialization is executed each time you launch a scan. If the **Auto-Level Check** option has been chosen, a step, corresponding to the verification of the tilt, will be performed before the initialization. If the **Color Acquisition** mode has been chosen (see [Setting the color acquisition mode](#)), the instrument rotates 60 degrees around its vertical axis, and captures one (or several) picture(s), and rotates again 60 degrees to capture new pictures, still it returns to its initial position. Once all of the steps are done, data acquisition starts and a progress bar appears.

NOTE – If the USB flash drive is full, a dialog appears only after tapping **Scan**.

NOTE – You can interrupt the acquisition of pictures in progress by tapping **Stop**.

2. The condition which allows the instrument to start acquiring data after tapping **Scan** is given in the table below. Select a condition specified in the following table. This condition combines the Compensator feature and the Auto Level Check function with the Leveling state of the instrument.

Instrument leveling status	Disable compensator option	Auto level check option	Scanning option
Out of Range	Unchecked	Unchecked	Enabled
Unleveled			
Leveled			
Out of Range	Unchecked	Checked	Disabled
Unleveled			
Leveled			Enabled
Out of Range	Checked	Unchecked	Enabled
Unleveled			
Leveled			
Out of Range	Checked	Checked	Enabled
Unleveled			
Leveled			

3. You can interrupt the acquisition in progress by tapping **Stop**.
4. You can pause and resume the acquisition in progress by tapping **Pause** or wait until it finishes.
5. On completion of the operation, the acquired data is written to the USB flash drive and a visual of the scan appears:



NOTE – If there is no USB flash drive in the instrument when tapping the Scan icon, a message appears and prompts you to insert one.

TIP – On the scan display screen, the Scan icon is always enabled. By tapping it, you can acquire another Full scan or perform an Area scan. You can check that you are still in the Full Scan acquisition mode in the next step (after tapping on the Scan icon) as the next page name is **Full Scan** and the framing area is indicated as 0° to 360°.



NOTE – When resetting the Personal Settings, the Area scan density defaults to the last setting used.

CAUTION – A warning message appears at the end of the acquisition if the instrument position has changed before, between, or after the scanning.

Once a full scan is complete, you have the option to perform another full scan within the same station or perform a scan of a specific area (known as an *Area scan*) or change the Instrument Height.



Changing the Instrument Height

If your instrument is a Trimble TX8, and it has been initially leveled (**green** bubble) and the **Compensator** enabled, once the scan is completed, you are able to change the **Instrument Height** you previously set.

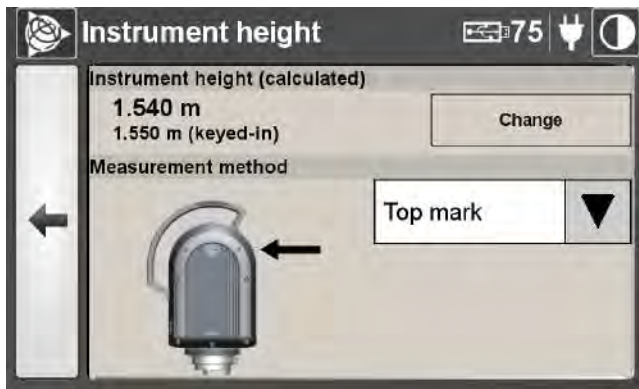
1. From the scan display screen, tap  and then tap . The **Instrument height** screen appears:



The keyed-in value displayed in the **Instrument height** pane and the **Measurement method** are those set in the **Scan Parameters** dialog.

2. Tap **Change** and the on-screen keyboard appears.
3. Enter the new value. You can add numbers that include a decimal point.
4. Tap **OK**. The on-screen keyboard disappears. The input value is shown in the **Instrument height** panel as well as the corrected value (obtained according to the formula given in the **Setup** chapter).
5. If required, tap the pull-down arrow and change the current method.
6. Tap  to return to the scan display dialog or tap  to return to the main menu.

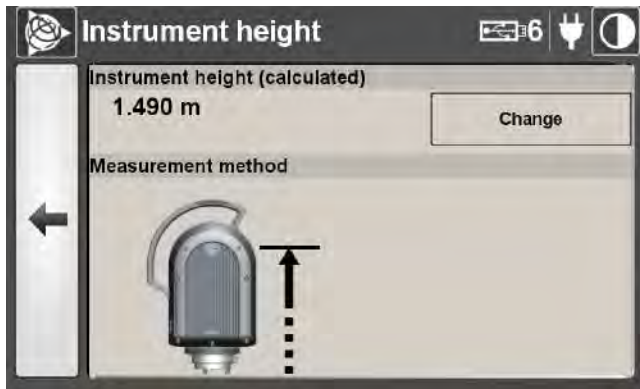

NOTE – If the instrument has not been initially leveled (the bubble is yellow in the **Leveling** window) or when it has been leveled (the bubble is green) but the **Compensator** is disabled, the **IH** icon  is grayed out.

NOTE – If you turn off the instrument or remove the USB drive from the instrument after a scan the **Measurement method** and the value you entered for the **Instrument height** are not saved in the project file. When you load that scan, the **Instrument height** dialog appears showing only the calculated value and the true height (the height from the point on the ground to the center of the instrument), as shown below.



Acquiring an area scan

You can only add an area scan to the **last** scan.

1. From the scan display screen, tap  and then tap the Area Scan icon . The Area Scan icon is highlighted in yellow and two vertical red lines show the boundary of the area to be scanned:



The default size of the scan area is one-third the size of the Full scan display. Areas that are shaded blue are not scanned.

NOTE – The **RGB** button is available only if the loaded scan has been acquired with colors.

2. Define a scan area:
 - a. Tap on a vertical line to drag it into position. When selected, the vertical line turns green. Drag the vertical lines to position the boundaries of the scan.

TIP – To return to Full scan mode for the current station, tap  again to remove the vertical lines.

- b. Tap . The Area scan dialog appears:

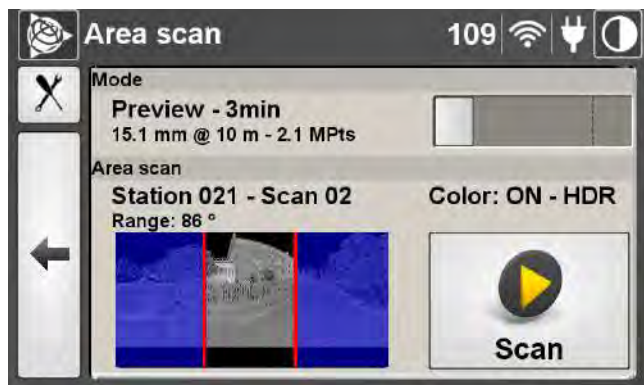



3. Set the mode of the scan. See [Choosing a scan mode](#).

NOTE – The “Color: On” (or “Color: On – HDR”) information appears in the **Area scan** dialog only if the **Color Acquisition** feature has been set to **Standard** (or **HDR**). Otherwise, it is blank.





NOTE – The “Exposure: Fixed” information changes to “Color: On” (or “Color: On – HDR”) and vice versa, in the **Area scan** dialog only if the **Fixed Exposure** feature has been set to **Enabled**.

The **Mode** parameter in this dialog may differ from the **Mode** parameter in the **Scan Parameters** dialog. For this reason, the number of scans that the USB flash drive can store may change.



4. Set the parameter of the scan by tapping . See [Scan parameters](#)
5. Tap .

Performing an additional area scan

Do one of the following:

- Tap  and then tap the Area Scan icon .
- Redefine the area to be scanned using the vertical bars.
- Tap the Scan button  to view the **Area scan** dialog.
- Tap the Scan button .

Canceling a scan

1. Tap **Stop**.
2. Either tap  or  to return to the main menu. A message appears asking whether or not you want to return the instrument to its origin.
3. Tap **Yes**. The instrument rotates to be positioned to its origin.

NOTE – A TZF file is created even if the scan has been interrupted.

Pausing and resuming a scan

1. Tap  to pause the scan in progress:

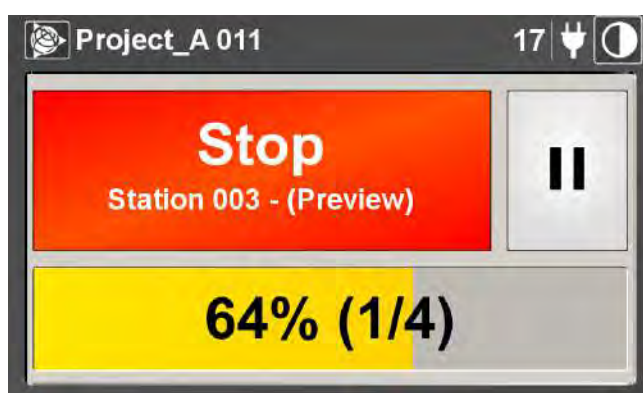

A countdown begins with a time of 2 minutes.

2. Tap  to resume the scan in progress:



3. If you do not resume the scan before the end of the countdown, it is canceled and saved.

A dialog appears asking if you want the instrument to return to its origin or not.



4. Tap **Yes**. The instrument rotates to be positioned to its origin.

5. Tap **Cancel**. The dialog closes.

6. Either tap  or  to return to the main menu.

NOTE – A single TZF file is created even no matter how many times the scan has been interrupted.

Deleting a scan

1. Tap . A Delete icon appears next to each scan, in place of the thumbnail.
2. Tap  next to each scan you want to delete. A dialog appears and prompts you to confirm the deletions.
3. Tap **OK**.

 **CAUTION** – Deleting a scan also deletes the related TZF file from the RWI folder on the USB flash drive.

Viewing a scan

1. If required, open a project.
2. In the list of stations, tap on a station thumbnail beside the station to load.
3. In the list of scans, tap a thumbnail image corresponding to the scan to be opened. The Lpic related to the loaded scan appears:



NOTE – The RGB button is available only if the loaded scan has been acquired with colors.

4. Tap  and then tap . A dialog appears and images are loaded:



NOTE – To hide the colors, tap again the RGB button.

NOTE – If you leave the displayed Lpic by tapping , this returns you to the main menu. If you tap the Projects icon, this will not display the list of stations but the list of scans.

Zooming In

Tap .

Zooming out

After zooming in, the Zoom Out button becomes enabled. To zoom out, tap .

Panning

Drag and drop the scan data in a given a direction to pan it in that direction.

Leveling

Leveling an instrument is the action of adjusting its vertical position using the three leveling screws of the tribrach located below the instrument. The electronic bubble in the **Leveling** dialog provides a visual control to check whether or not the instrument is leveled. It may have three states: Out of Range (not visible), Yellow, or Green.

In addition to the electronic bubble, the **Leveling** dialog displays the Trunnion and Sighting information. The horizontal rotation's axis of the instrument is called Trunnion, while its sighting direction for acquiring cloud data is called Sighting. Both are expressed in degrees, minutes, and seconds. When activated, the Compensator will automatically level-compensate all 3D points.

Checking the leveling status of the instrument

1. From the main menu, tap . The **Leveling** dialog appears.

When the instrument is leveled, the color of the electronic bubble color is green and centered:



When the instrument is unlevelled, the color of the electronic bubble is yellow and it appears off-centered:

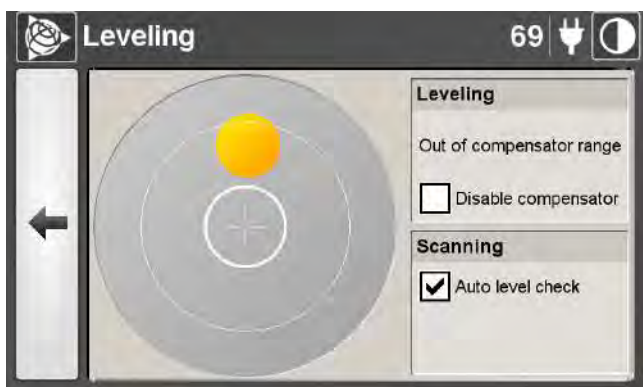

When the instrument is out of range, the electronic bubble is not visible on the screen. A green arrow indicates the direction the bubble is:



2. From this dialog, you can:

- Level the instrument. See [Leveling the instrument](#).
- Activate (or deactivate) the compensator. See [Activating \(or deactivating\) the compensator](#).
- Activate (or deactivate) the Auto level check. See [Activating \(or deactivating\) the Auto level check](#).

NOTE – A warning with the message "*unconsistent leveling status before and after scanning. Last scan data not impacted*" will be displayed in case you scanned while the instrument is out of the leveling range.

Leveling the instrument



To adjust the vertical position of the instrument, turn the three foot screws of the tribrach below the instrument until the electronic bubble level first turns green and then becomes centered in the middle of the bull's-eye.





Activating (or deactivating) the compensator

The Compensator, which has a vertical compensation feature, automatically level-compensates all 3D points. You can decide whether or not to apply this feature.

To activate the compensator:

1. In the **Leveling** panel of the **Leveling** dialog (see [Leveling](#)), ensure that the **Disable compensator** option is cleared.
2. Tap  to return to the **Leveling** dialog or tap  to return to the main menu.



To deactivate the compensator:

1. In the **Leveling** panel of the **Leveling** dialog, select the **Disable compensator** option.
2. Tap  to return to the **Leveling** dialog or tap  to return to the main menu.



Activating (or deactivating) the Auto level check

The Tilt component in your instrument is a dual-axis detector (Trunnion and Sighting axes).

To activate the Auto level check:

1. In the **Scanning** panel of the **Leveling** dialog (see [Leveling](#)), select the **Auto level check** option.
2. Tap  or  to return to the main menu.

To deactivate the Auto level check:

1. In the **Scanning** panel of the **Leveling** dialog (see [Leveling](#)), ensure that the **Auto level check** option is not selected.
2. Tap  or  to return to the main menu.

Scan parameters

1. From the main menu, tap .

If you do not have a USB flash drive attached to the instrument, a message appears and prompts you to insert one.

The **Scan Parameters** dialog appears. It looks as shown below, for the Trimble TX6 and TX8 standard version:

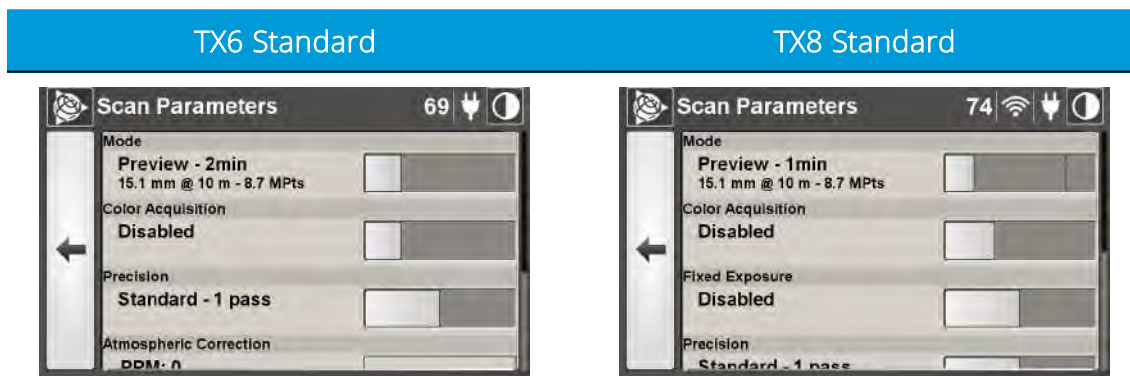

The **Scan Parameters** dialog looks as shown below, for the Trimble TX6 and TX8 when the extended range option is enabled:

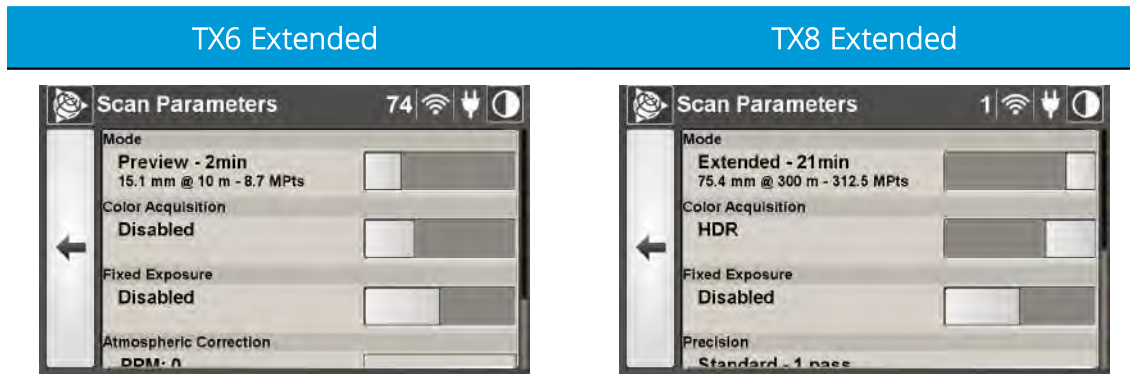

2. In this dialog, you can:
 - Choose a scan mode. See [Choosing a scan mode](#).
 - Set the color acquisition mode. See [Setting the color acquisition mode](#).
 - Enable the Fixed Exposure mode. See [Enabling the fixed exposure mode](#).
 - Choose a scan precision (only available with the Trimble TX8). See [Choosing a scan precision](#).
 - Apply an atmospheric correction. See [Applying an atmospheric correction](#).

- Enter the Instrument height (only available with the Trimble TX8). See [Entering the instrument height](#).
- Set the self-timer. See [Using the self-timer](#).

Choosing a scan mode

A scan mode corresponds to a level (or density) of a scan.

For the Trimble TX8, there are five predefined modes: Preview, Level 1, Level 2, Level 3, and Extended. Extended is a level that only appears if you have purchased the Extended Range upgrade.

For the Trimble TX6, there are only four modes: Preview, Level 1, Level 2 and Level 3. The following table shows the parameters of each mode, as well as estimates about the number of points that will be acquired and the duration of the scan:

Type	Mode	Spacing ¹ (mm)	At a Distance of (m)	Number of points (millions of points)	Duration (min for 1 pass)						Duration (min for 4 passes)								
					S-F ²			D-F ³			S-F			D-F					
					-	S ⁴	H ⁵	-	S	H	-	S	H	-	S	H			
TX8 Series	TX8 Series																		
	TX6 Series	TX6 Series									N/A			N/A			N/A		
		Preview	15.1	10	8.7	2	3	4	1	2	3	7	9	9	4	6	6		
		Level1	22.6	30	34.7	3	4	5	2	3	3	12	13	14	7	8	8		
		Level2	11.3	30	138.9	5	7	7	3	4	5	21	22	23	11	12	13		
		Level3	5.7	30	555.5	19	20	21	10	11	11	76	77	78	39	40	40		
N/A	Extended	75.4	300	312.5	37	39	39	19	20	21	N/A			N/A					

¹The Spacing parameter is the distance between two consecutive laser spots.

²SF stands for Single Face (Front Face or Back Face in the Scanning Face mode).

³DF stands for Dual Face (in the Scanning Face mode).

⁴S stands for Standard option in the Color Acquisition feature.

⁵H stands for HDR option in the Color Acquisition feature.

To choose a scan mode:

- In the **Mode** panel, move the slider to a position for Level 1, Level 2, Level 3, or Extended. The Extended position on the right does not display unless the Extended Range upgrade has been enabled. The scan duration will vary for each chosen scan

mode depending on the precision that is set (that is, Standard 1-Pass or High 4-Pass), on the scanning face that is chosen (that is, Dual Face or single face (Front Face or Back Face)), and on the color acquisition mode that is chosen (that is, Standard or HDR).

NOTE – If you are using a Trimble TX8, be aware that your instrument will scan beyond 120 meters when the Extended Range feature is chosen.

When scanning with Extended mode, two scans will be acquired. The first scan is a short range scan from 0 to 120 m, and the second scan is a long range scan from 120 to 340 m. The time to acquire the short range scan is shorter than the time to acquire the long range scan. The total scan duration is 19 minutes with the Dual Face scanning mode, and 38 minutes with the Front Face (or Back Face) scanning mode. Two TZF format files are created under the RWI folder:

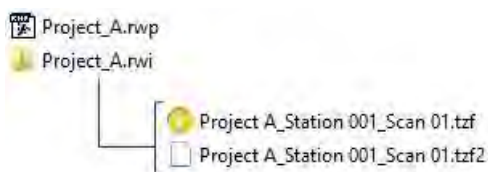

The number of scans that can be stored on the USB flash drive changes according to the chosen mode.

The mode for a Full scan can be defined from the **Scan Parameters** dialog (see [Scan parameters](#)), while the mode chosen from the **Area Scan** dialog is applied to an Area scan. When you reset your personal settings (see [Personal settings](#)), the mode of both types of scans is reset to Preview.

In the main menu, the **Spacing** value for the scan mode is rounded up or down to the nearest value as shown below:

- Preview: 15.1 mm (15 mm)
- Level 1: 22.6 mm (23 mm)
- Level 2: 11.3 mm (11 mm)
- Level 3: 5.7 mm (6 mm)
- Extended: 75.4 mm (75 mm)

Setting the color acquisition mode

The Color Acquisition mode, when enabled, will capture pictures to colorize the acquired data.

CAUTION – Using the Color Acquisition option will increase the time required to acquire a scan.

CAUTION – When you use the Color Acquisition mode in sunlight (or in a very dark environment), be aware that the time the camera will take to get the right exposure may be longer than usual.

In the **Color Acquisition** panel, move the slider to a position:

- Disabled



If you select the Disabled option, the TX instrument will capture no picture.

- Standard

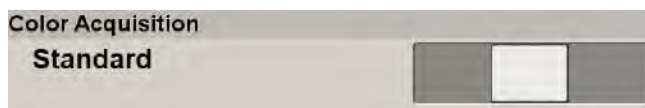

If you select the Standard option, the TX instrument will capture six pictures covering horizontally a field of view of 360°, and vertically a field of view of 180°. Each picture has its own exposure.

- HDR

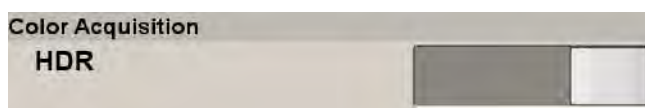

If you select the HDR option, the TX instrument will also capture six pictures with six different exposures, covering horizontally a field of view of 360°, and vertically a field of view of 180°. For each picture, two additional pictures will be taken, one darker and one brighter.

NOTE – You can interrupt an acquisition of pictures in progress by tapping **Stop**.

Enabling the fixed exposure mode

The Color Acquisition feature, in the Standard mode (or in the HDR mode), takes a series of 6 (or 6x3) pictures at different exposures. The panorama, resulting from the stitching of the series of 6 (or 6x3) pictures, may display a banding effect caused by different exposures.

The Fixed Exposure feature, when enabled for Color Acquisition, applies the exposure of the first picture taken to the rest of the pictures in the scan. As a result, the banding effects are significantly reduced, but some pictures may be overexposed or underexposed.

To optimize results and avoid over or under exposure on some images, Trimble recommends you place and direct the instrument so that the first picture will be taken in front of a light source such as a window, lamp.

NOTE – The Fixed Exposure mode, once chosen, becomes persistent. It remains so until you initialize your settings to the default values.

Choosing a scan precision

The Precision parameter defines the number of times a scan will be acquired from the same station. The Standard 1-Pass option has range noise < 2 mm from 2 m to 120 m on 18 to 90% reflective surfaces. The High 4-Pass option has range noise < 1 mm from 2 m to 80 m on 18 to 90% reflective surfaces. The Precision options are used with Level 1, Level 2, and Level 3 scan modes, but the option is dimmed with the Extended mode as it automatically defaults to a 1-Pass scan.

NOTE – The High Precision 4-Pass option is only available with the Trimble TX8.

CAUTION – Using the High Precision 4-Pass option will increase the time required to acquire a scan.

In the Precision panel, move the slider to a position:

- Standard 1-Pass:



- High 4-Pass:



- With the High 4-Pass precision, the percentage complete of the scan being acquired and the scans remaining display in the progress bar:

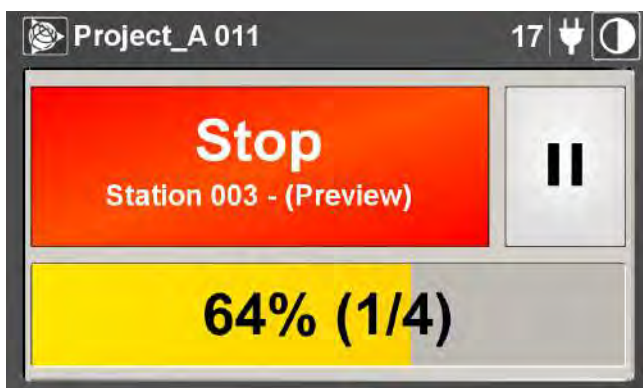

When scanning with High 4-Pass precision, four TZF format files are created under the RWI folder. Standard 1-Pass precision creates one scan under the RWI folder:

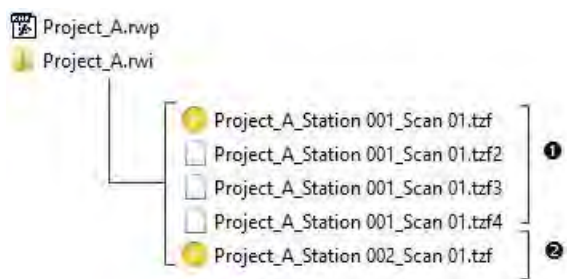

-
- ① A high precision scan
-
- ② A standard precision scan
-

NOTE – The HP acronym, next to the scan mode on the main page, indicates that the 4-Pass option has been chosen. No indication means that the 1-Pass option has been chosen.

Applying an atmospheric correction



The instrument uses the EDM (Electronic Distance Measurement) technology to collect points. Distance measurement is function of the velocity of light in the atmosphere and the velocity of light depends on the refractive index of air, temperature, pressure, and humidity. The Atmospheric Correction feature applies corrections to the distance measurement—expressed in PPM (Parts Per Million)—according to these atmospheric conditions.

The default PPM value is zero. This value can be entered or it can be computed from both the Pressure value and the Temperature value.

To change a PPM value:

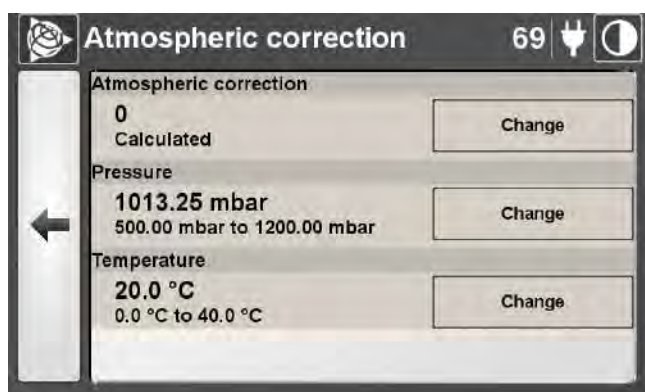
1. In the **Atmospheric correction** panel of the **Scan parameters** dialog (see [Scan parameters](#)), tap **Change**. The **Atmospheric correction** dialog appears:



2. In this dialog, you can:
 - Enter a PPM value. See [Entering a PPM value](#).
 - Change the Pressure value. See [Changing the Pressure value](#).
 - Change the Temperature value. See [Changing the Temperature value](#).
3. Either tap  to return to the **Scan Parameters** dialog or tap  to return to the main menu.

NOTE – The new PPM value, once defined, remains unchanged and is applied to scans from when it has been defined until you change it again or even if the scanner has been turned off and on or after an update of the firmware.

NOTE – The PPM value will not be updated if only one of the two parameters (either the Pressure or the Temperature) is defined.

Entering a PPM value

In the **Atmospheric Correction** panel, the "Keyed In" text below the PPM value means that you have manually entered the value. When the "Keyed In" text is not present, the PPM value is a computed value calculated from both the Pressure value and the Temperature value.

To enter a PPM Value:

1. In the **Atmospheric Correction** panel of the **Atmospheric correction** dialog (see [Applying an atmospheric correction](#)), tap **Change**. An on-screen keyboard appears with the current PPM value highlighted.

The keys that you can use are: 0, 1, 2, ... 9 and + and -. The value you can enter ranges from -73 to +145.

If you enter a value lower than -73 or higher than +145, this value is automatically rounded to -73 or to +145.

2. Enter a value and then tap **OK**. The on-screen keyboard disappears.

As the Temperature value and the Pressure value cannot be exactly deduced from the PPM value, both are set as blank. Similarly, when you change the current PPM value, which is previously different from zero, to zero, this will set the Temperature and Pressure values to blank.

Changing the Pressure value

To change the pressure value:

1. In the **Pressure** panel of the **Atmospheric correction** dialog (see [Applying an atmospheric correction](#)), tap **Change**. An on-screen keyboard appears with a blank field:

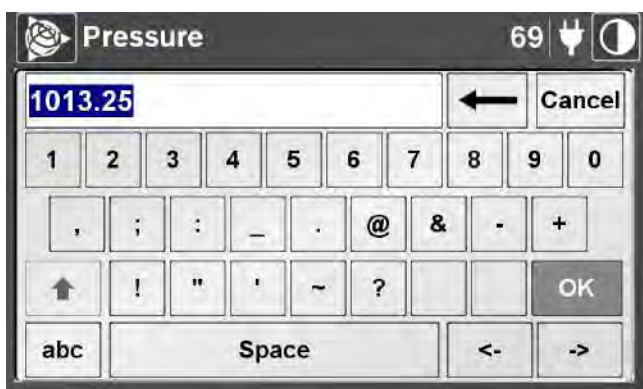

The keys you can use are 0, 1, 2 ... 9 and ".". The value you can enter ranges from 870 mbar to 1020 mbar.

If you enter a value lower than 870 mbar (or higher than 1020 mbar), this value is automatically rounded to 870 mbar (or to 1020 mbar).

2. Enter a value and then tap **OK**. The on-screen keyboard disappears. The new value appears in the **Pressure** panel using the unit of measurement defined in the **Settings** dialog (see [Selecting the measurement units](#)).

The newly input Pressure value will not update the current PPM value if there is no value in the **Temperature** panel (the current PPM value equal to Zero). You also need to define the Temperature value.

Changing the Temperature value

To change the temperature value:

1. In the **Temperature** panel, tap **Change**. An on-screen keyboard appears with the current temperature highlighted or a blank field:

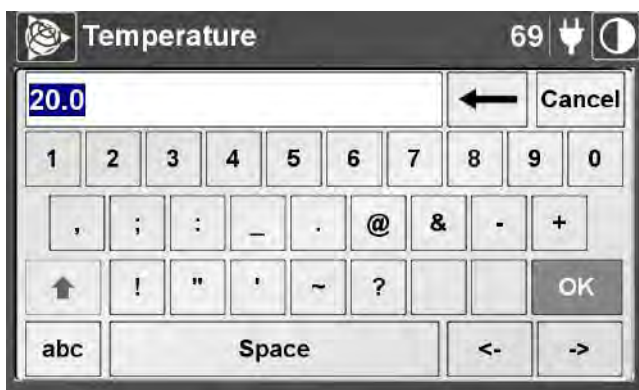

The keys you can use are 0, 1, 2 ... 9 and ".". The value you can enter ranges from 0 °C to +40 °C.

If you enter a value lower than 0 °C or higher than 40 °C, the value is automatically rounded to 0 °C or to 40 °C.

2. Enter a value and then tap **OK**. The on-screen keyboard disappears. The new value is then displayed with the unit of measurement that is defined in the **Settings** screen (see [Settings](#)).

The newly input Temperature value will not update the current PPM value if there is no value in the **Pressure** panel (the current PPM value equal to Zero). You also need to define the Pressure value.

Entering the instrument height

NOTE – If you are using a Trimble TX6, you are not able to set the Instrument Height. The survey workflow is not supported.

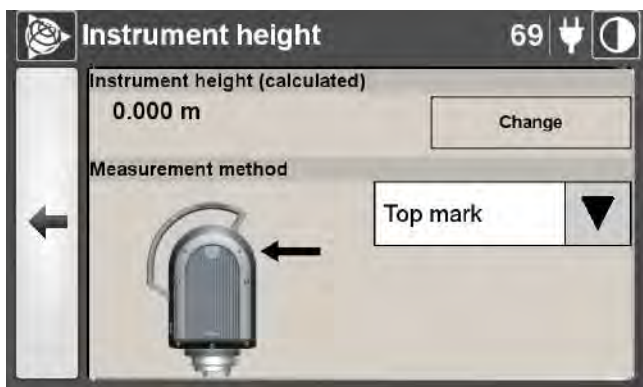

If your instrument has been initially leveled (green bubble) and the **Compensator** enabled, you are able to enter the **Instrument Height**.

1. In the **Instrument height** panel, tap **Change**. The **Instrument height** screen appears:

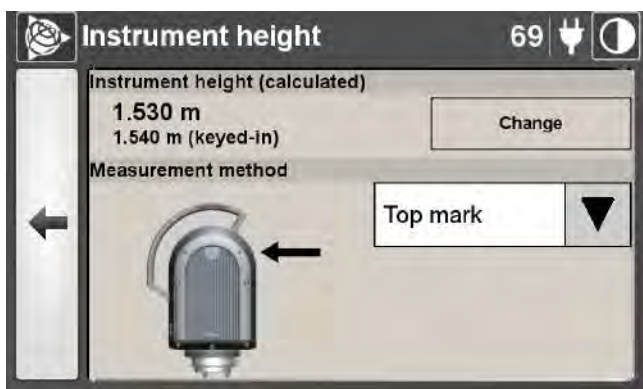

2. Tap **Change**. The on-screen keyboard appears.
3. Enter the value measured in the field. You can add numbers that include a decimal point.
4. Tap **OK**. The on-screen keyboard disappears. The keyed in value and the calculated value are displayed:



5. In the **Measurement method** panel, tap the pull-down arrow and select **Top mark** or **Bottom mark**. The calculated value changes according to the chosen method.
6. Tap  to return to the **Scan parameters** dialog or tap  to return to the main menu.

NOTE – If the instrument has not been initially leveled (the bubble is yellow in the Leveling window) or when it has been leveled (the bubble is green) but the Compensator is disabled, you are not able to enter the instrument height and the Instrument height panel may show "Not Leveled" and the **Leveling** button in place of the **Change** button.

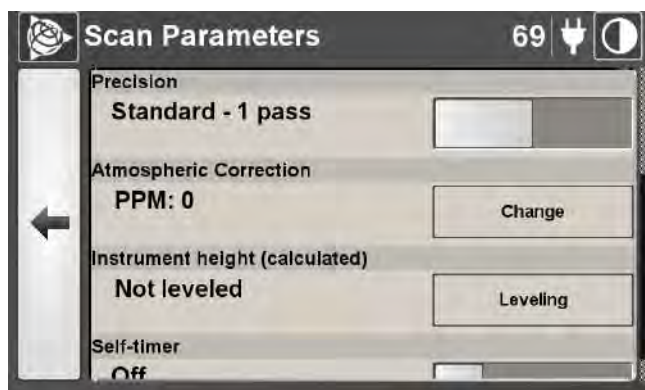

Using the self-timer

You can use the self-timer to set a delay between the time you tap **Scan** and the time the scan starts. There are three times: 1 minute, 3 minutes, and 5 minutes.

In the Self-Timer panel, move the slider to a position:

- Off



- 1 minute



- 3 minutes



- 5 minutes



The Self-Timer turns on by itself when you set a time, and its icon  appears on the top toolbar.

When you start a scan with the Self-Timer set, a countdown begins to show the time remaining before the scan starts:



Settings

To change the general settings:

1. From the main menu, tap . The **Settings** dialog appears:

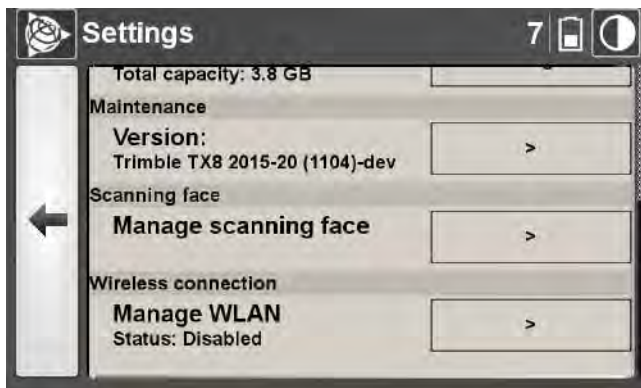

2. In this dialog, you can:
 - Set the date and time. See [Setting the date and time](#).
 - Select the measurement units. See [Selecting the measurement units](#).
 - Manage the USB flash drive. See [Managing the USB flash drive](#).
 - Maintain the system. See [Maintenance](#).
 - Set the scanning face. See [Scanning Face](#).
 - Set the wireless connection. See [Setting a wireless connection](#).

Setting the date and time

If the default date and time settings do not match the current time zone, change them manually. The format is Year/Month/Day (date) and Hour/Minutes/Seconds (time).

The **Date - Time** panel shows the current date and time.

1. Next to the **Date - Time** panel, tap **Change**. The **Change Date & Time** dialog appears:



2. Tap in a field. It is highlighted in yellow:

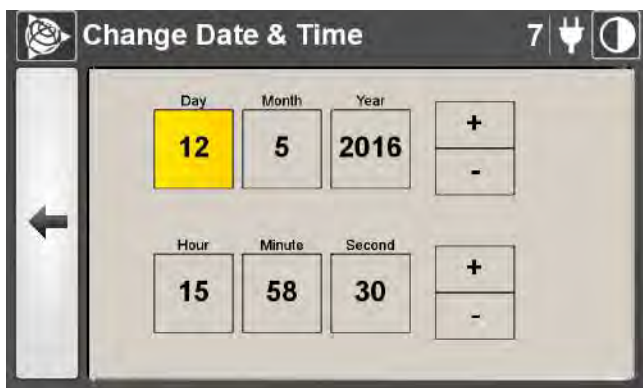



3. Tap **+** to increase or **-** to decrease by one digit until the date and time change to your requirements.
4. Either tap **←** to return to the **Settings** dialog or tap  to return to the main menu.

Selecting the measurement units

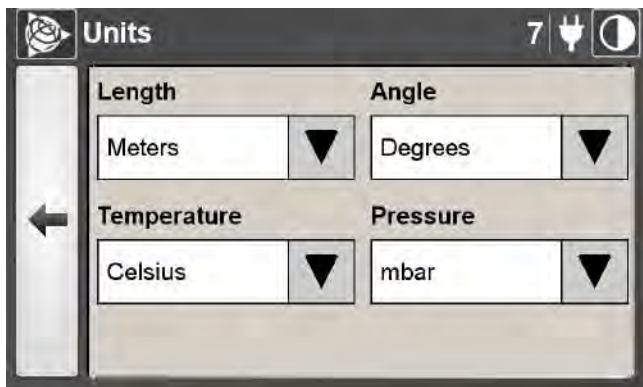
The **Units** panel shows the current unit of measurement for the length, angle, temperature, and pressure:



1. Next to the each field, tap the down arrow and select the required units for length, angle, temperature, and pressure.
2. Tap  to return to the **Settings** dialog or tap  to return to the main menu.

Managing the USB flash drive

The **USB flash drive** panel shows the total capacity of the USB flash drive in GB, and the remaining storage capacity of the drive, in percentage. You can also test the speed of the attached USB drive, check it for errors, repair it, or format it.

To manage the USB flash drive:

1. In the **USB flash drive** panel, tap **Manage**. The **USB flash drive** dialog appears:

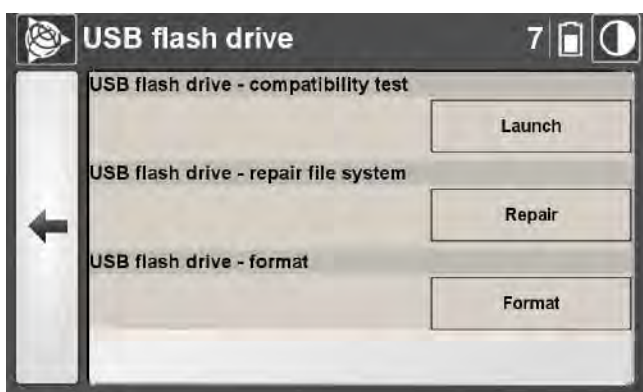

2. In this dialog, you can:
 - Test for USB flash drive compatibility. See [Compatibility Test](#).
 - Check and repair the USB flash drive. See [Repair file system](#).
 - Format the USB flash drive. See [Format](#).

Compatibility Test

You can test the write performance of your USB flash drive. Trimble recommends it is at least 16 MB.



To perform a compatibility test:

1. In the **USB flash drive - compatibility test** panel, tap **Launch**. The **USB flash drive - compatibility test** dialog appears.
2. Tap **OK**. The compatibility test is then performed with a progress bar showing the progress in percent.
3. Once complete, tap **OK**. The dialog closes and the **USB flash drive** dialog reappears.

If the USB flash drive is not compatible with the system, replace it with a faster one.

Repair file system



1. In the **USB flash drive - repair file system** panel, tap **Repair**. The **USB flash drive - repair file system** dialog appears.
2. Tap **OK**. The repair is then performed.
3. Once complete, tap **OK**. The main menu automatically appears.

While the USB flash drive is being repaired, USB Flash Drive icon on the main menu flashes from red  to white (or to black and white  in the High Contrast mode).

Format

 **CAUTION** – Formatting a USB flash drive deletes all the data on the drive. A new empty project named Project 001 is created once the formatting is completed so that you can start scanning. This project takes the name of the last project with the value of 001 if the name ends by a letter, or the name of the last project with an increment if the name ends by a number.

1. In the **USB Flash Drive - Format** panel, tap **Format**. The **USB Flash Drive - Format** dialog appears.
2. Tap **OK**. The reformatting is then performed.
3. Once done, tap **OK**. The main menu appears.

While the USB flash drive is being repaired, USB Flash Drive icon on the main menu flashes from red  to white (or to black and white  in the High Contrast mode).

Maintenance

You can keep your instrument up to date by updating its firmware, running a diagnostics test to check each of its components, or resetting all your personal settings.

1. In the **Maintenance** panel, tap >. The **Maintenance** dialog appears:

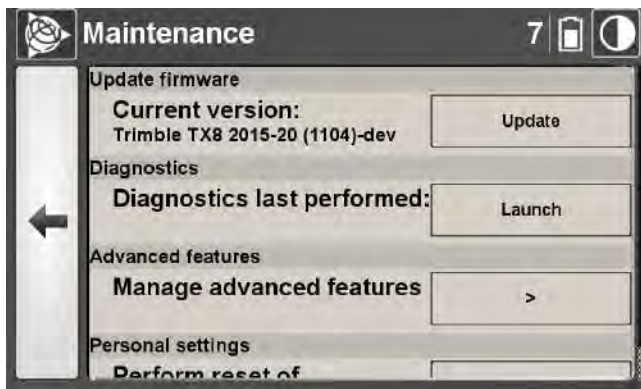

2. In this dialog, you can:
 - Update the firmware. See [Update Firmware](#).
 - Run a diagnostics test. See [Diagnostics](#).
 - Access the advanced features of the software. See [Advanced features](#).
 - Reset all personal settings. See [Personal settings](#).

Update Firmware

In the **Update Firmware** panel, you can view the version of the current firmware in use. A firmware file is in DAT format. Before performing a firmware update, copy the new firmware file (.dat) to the root of your USB flash drive and then plug the USB flash drive into the USB port of the instrument.



To perform a firmware update, you must connect an external power supply to the instrument instead of using the internal battery (see [Powering the instrument](#)). Otherwise, the **Select** button beside the firmware to select remains dimmed.

1. Tap **Update**. The **Firmware Update** dialog appears.
 - If there is a firmware file in the USB flash drive, it appears in the **Select Firmware** list.
 - If there is no firmware file in the USB flash drive, the message **No Firmware Found On The USB Flash Drive** appears.
2. Tap **Select** next to the firmware file to be uploaded. The **Firmware Update** dialog appears and prompts you to update the firmware with the selected firmware file.
3. Tap **OK**. When the upload has completed, restart the instrument. See [Turning the instrument on and off](#).
4. First switch the instrument off and then on. The **Firmware Update** dialog reappears.
5. Tap **OK**.
6. When the update is complete, tap **OK** again. The **Firmware Update** dialog closes.

Diagnostics

In the **Diagnostics** panel, you can view when the last diagnostics test was performed. You can also open the report of the last diagnostics test.

To start a diagnostics test:

1. Tap **Launch**. A dialog appears and prompts you to perform a diagnostics test.
2. Tap **OK**. If no scan has been performed initially, the instrument will perform an initialization. If a scan has been previously performed, the diagnostics test starts.
3. Once complete, the instrument oscillates a few degrees on either side of its zero. When prompted, tap **OK**. The Diagnostics report then appears.
4. To close the report, either tap  to return to the **Maintenance** dialog or tap  to return to the main menu.

The Diagnostics report is automatically saved on the USB flash drive in two file formats: TXT and HTML. Each report follows a naming convention:



Autotest-YearMonthDay-HourMinuteSecond.

The date and time of the last diagnostics test, respectively in the "Day-Month-Year" and "Hour-Minutes-Seconds" formats are displayed in the **Diagnostics** panel. This information is not stored in the USB flash drive but in the instrument itself. When you format your USB flash drive, only the report(s) are deleted, not the date and time information. To remove them, you need to reset your personal settings (see [Personal settings](#)).

NOTE – *You can run a diagnostic even if the USB flash drive is missing from the instrument. The report will only be viewable from the on-board interface and will not be saved.*

To open a report:

The series of three dots in the **Diagnostics** panel means that there is at least one report you can open.

1. Tap on **Diagnostics Last Performed**. The Diagnostics report appears.
2. Tap  to close the report and return to the **Maintenance** dialog or tap  to return to the main menu.

Advanced features

The Trimble TX6 and TX8 come standard with a scan range of 80 meters and 120 meters. The Extended Range feature is an optional upgrade to increase the TX6 scan range from 80 meters to 120 meters and to increase the TX8 scan range from 120 meters to 340 meters. Registration codes are entered in the scanners to activate extended range. Note that the Trimble TX6 cannot be upgraded to a Trimble TX8.

To activate the Extended Range feature:

1. In the **Advanced features** panel of the **Maintenance** dialog, tap > (see [Maintenance](#)). The **Advanced features** dialog appears:

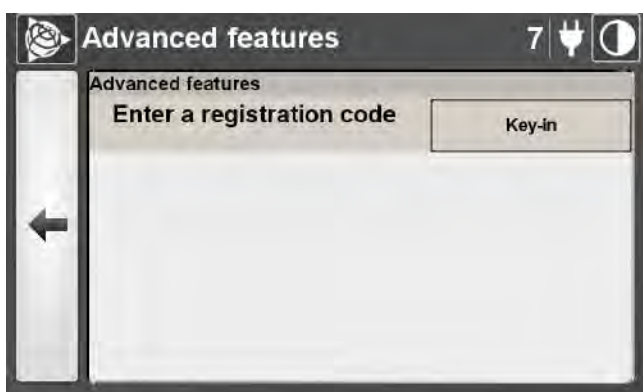

2. Tap **Key-In**. An on-screen keyboard appears.
3. Enter the Registration Code (for purchasing information, please contact your local Trimble authorized dealer).
4. Tap **OK**. The on-screen keyboard disappears. The Extended Range feature is now enabled.

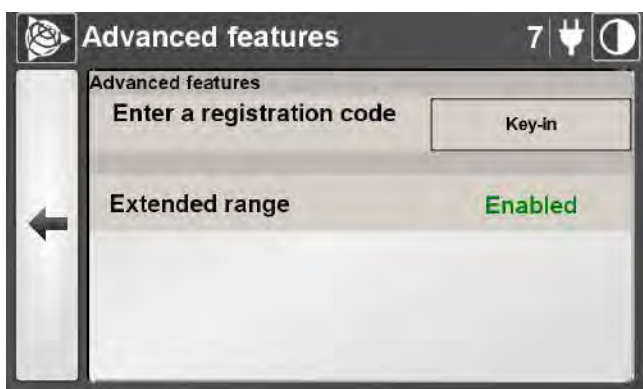

5. Either tap  to return to the **Settings** dialog or tap  to return to the main menu.

Personal settings

1. In the **Personal settings** panel, tap **Reset**. The **Settings** dialog appears.
2. Tap **OK**. The following settings are reset to the default values.
 - The current unit for Length, Angle, Temperature, and Pressure resets to Meters, Degrees, Celsius, and mbar.
 - The Full scan's mode resets to Preview.
 - The Area scan's mode resets to Preview.
 - The Color Acquisition's mode resets to Standard.
 - The Fixed Exposure's mode resets to Disabled.
 - The Precision scan's mode resets to Standard 1-Pass, with a TX8 instrument. This mode is not available with a TX6 instrument.
 - The Self-Timer resets to Off.
 - The Scanning Face's mode resets to:
 - Dual Face, with a TX8 instrument.
 - Front Face, with a TX6 instrument.
 - The Wireless Connection's mode resets to Disabled.
 - The last Operator Name resets to blank.
 - The PPM value resets to zero.
 - The Pressure value resets to 1013.25 mbar.
 - The Temperature value resets to 20 °C.
 - The last diagnostics test date.
3. Tap **OK** again.

NOTE – When you reset your Personal Settings to the default values, this does not reset the name of the current (open) project. This name will be used for each project that will be created, with the rules described previously. To reset the name of a project to be created to the default value, for example, Project 001, you can either edit the name once the project is created, or remove the USB flash from the drive and then reset the Personal Settings.

Scanning Face

The Trimble TX8 and TX8 Extended scanners can operate in **Dual-Face** or **Single-Face** (**Front face** or **Back face**) scanning modes:

- **Dual-face** mode is the default setting and is recommended to reduce scan times. When the dual-face mode is enabled, a full 360° scan is captured with a 180° horizontal rotation.
- **Single-face** mode is only recommended if users notice a significant quality difference between the front and back face of dual-face scans, for example, lower density of points on areas with low reflectivity materials, lower maximum achievable range, severe brightness difference for objects above 50 m. This could be the result of extreme temperatures outside of the scanner's operating range or to abnormal shocks/vibrations.

Scanning with the single front or back face option may enable users to eliminate these quality differences. Scan times will be doubled with a full 360° scan, requiring a complete 360° horizontal rotation. You must select the best face for the job - either front or back. Check with a test scan where quality differences can be witnessed to ensure that the correct face is selected **before** continuing a project. Significant quality difference between faces can very rarely be witnessed in indoor conditions or below 50 m.

NOTE – The Trimble TX6 and TX6 Extended 3D scanners do not have the Dual -Face scanning capability. The user can only acquire data with the **Front face** (or **Back face**) scanning mode.

To set the scanning face mode:

1. On the **Settings** page, scroll down to **Scanning face** and then tap >:



2. On the **Scanning Face** page, you can do the following:

- To set the scanning face mode to **Dual face** (the recommended default setting), move the slider to the left position.



- To set the single-face scanning mode to **Front face**, move the slider to the middle position.



NOTE – Before acquiring data with a TX8 instrument, the *Duration* and the name of the single-face flash on the main page. With a TX6 instrument, only the *Duration* is displayed.

NOTE – During the acquisition of data, the *Front Face* text is displayed as a reminder, below the **Stop** button.

- To set the single-face scanning mode to **Back face**, move the slider to the right position.



***NOTE** – During the acquisition of data, the Back face text is displayed as a reminder, below the Stop button.*

Setting a wireless connection

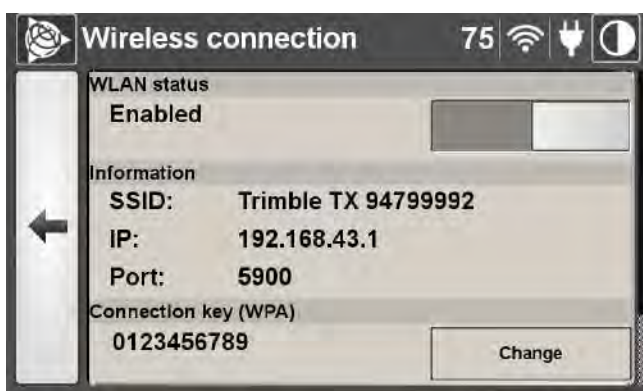

- In the Wireless Connection panel, tap >. The Wireless Connection dialog appears:



- In this dialog, you can:
 - Enable / disable the wireless connection. See [Enabling / Disabling the wireless connection](#).
 - Change the encryption key. See [Changing the encryption key](#).
 - Change the Wi-Fi channel. See [Changing the Wi-Fi channel](#).

Enabling / Disabling the wireless connection



To enable the wireless connection:

- In the WLAN Status panel, move the slider to the right position. A dialog pops up with the “Enabling WLAN....” message.
- Either tap  to return to the Settings dialog or tap  to return to the main menu.

A dialog pops up with the “**Enabling WLAN...**” message.

The WLAN Status switches to **Enabled** and the Wi-Fi signal symbol  is displayed on the main page.

To disable the wireless connection:

1. In the **WLAN Status** panel, move the slider to the left position. A dialog pops up with the “**Disabling WLAN...**” message.
2. Either tap  to return to the **Settings** dialog or tap  to return to the main menu. The WLAN Status switches to “Disabled” and the Wi-Fi signal symbol is hidden from the main page.

Changing the encryption key



WPA, which stands for Wi-Fi Protected Access, in version 2, is a security protocol used for encrypting data exchange between your TX instrument and your remote device, over the wireless connection.

The encryption key is an alpha-numeric password between 8 and 63 characters long. The default value of the encryption key is 0123456789. You can change the value of this key. The exact same key must be entered in the **Connection Key (WPA)** panel and in the **Connect to a Network** dialog (see [Connecting to the instrument over the Wi-Fi](#)).

To change the encryption key:

1. In the **Connection Key (WPA)** panel, tap **Change**. An on-screen keyboard appears with the current value highlighted.
2. Tap  to switch the keyboard from alphabetic to numeric.



3. Enter a value and then tap **OK**. A dialog pops up with the “Updating WLAN Connection WLAN...” message.
4. Either tap  to return to the **Settings** dialog or tap  to return to the main menu.

NOTE – If the input value is incorrect, a dialog pops up and prompts you to input a valid value in place.

Changing the Wi-Fi channel

If you find your Wi-Fi connection is slow or drops out, try changing its channel. Your TX instrument complies with the 802.11 b/b/n wireless standard. There are a total of 14 channels, from 1 to 14, in this 2.4 GHz range.

To change the Wi-Fi channel:

1. In the **Channel** panel, tap **Change**. An on-screen keyboard appears with the current value highlighted.

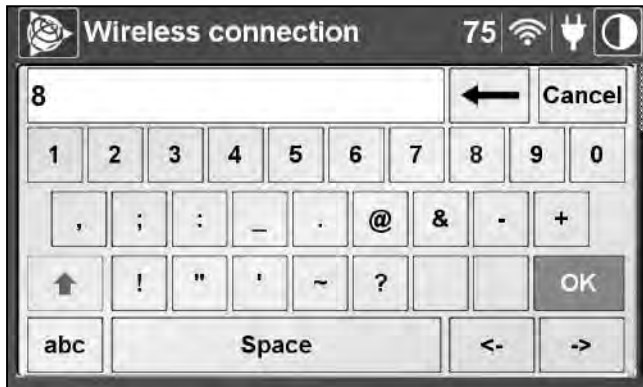

2. Enter a new number and then tap **OK**. A dialog pops up with the “**Updating WLAN Connection WLAN....**” message.

Specifications

- ▶ Scanner only specifications
- ▶ Shipping box specifications
- ▶ Instrument case specifications
- ▶ External power supply specifications
- ▶ USB flash drive specifications
- ▶ Battery kit specifications
- ▶ Smart battery specifications
- ▶ Two-bay charger specifications
- ▶ Tribrach specifications
- ▶ Micro fiber lens cleaning cloth specifications
- ▶ USB cable specifications
- ▶ Auto-Start specifications

This chapter summarizes the specifications of the TX 3D scanner.

Scanner only specifications

Dimensions (W x H x D - scanner only)	335 mm x 412 mm x 242 mm
Volume (scanner only)	26921 cm
Weight	11.8 kg (without tribrach, battery, or USB flash drive)
Operation	<p>The Trimble TX 3D scanner, is classified IP54 according to the international standard IEC 60529. It is a night and day scanner that can scan under the following conditions:</p> <ul style="list-style-type: none"> • Wet or dry weather (humidity range from 0% to 80%), • Hot or cold conditions (temperature range from 0 °C to +40 °C).
Maximum sound level	73 dB
Storage	The instrument can be stored inside its box at temperatures ranging from -20 °C to +50 °C.
Touchscreen display module	<p>TFT-LCD with 24-bit color Size (mm): 93 (H) x 55.8 (V), equivalent 4.3" diagonal Resolution: 800 X 480 (WVGA)</p>
Camera module	<p>Resolution (H x V pixels): 3856 x 2764 Sensor Size (Optical): 1/2.35" Pixel Size (µm): 1.67 x 1.67 Frame Rate: 7.3 Sensor Technology: CMOS Readout Type: Rolling ADC resolutions: 12</p>
Wi-Fi module	<p>Wi-Fi Protocol: 802.11b/g/n Transmit & Receive Level: -84 (Rx) to +17 (Tx) dBm Max. Data Rate Receiving:</p> <ul style="list-style-type: none"> • 300 Mbps (40 MHz) • 150 Mbps (20 MHz) <p>Max. Data Rate Transmitting:</p> <ul style="list-style-type: none"> • 300 Mbps (40 MHz) • 150 Mbps (20 MHz)

Shipping box specifications

Dimensions (W x H x D)	475 mm x 720 mm x 595 mm
Weight	2.5 kg (empty)

Instrument case specifications

Dimensions (L x W x D - scanner only)	Exterior: 625 x 500 x 366 mm Interior: 559 x 432 x 322 mm
Weight	10.61 kg (with foam), 8.83 kg (without foam)
Temperature range	-29 °C to 60 °C

External power supply specifications

Dimensions (W x H x D)	130 mm x 76.2 mm x 43.7 mm
Weight	660 g
Cable length	Power cable connected to unit: 1.8 m Power cable provided with connectors: 2.1 m
Temperature range	-29 °C to 60 °C
Voltage	Input: 90 to 264 VAC Output: 12 V
Frequency	Input: 47 - 63 Hz
Current	Input: <ul style="list-style-type: none"> • 90 W: 1.2 A at 115 VAC, 0.6 A at 230 VAC • 120 W: 1.6 A at 115 VAC, 0.8 A at 230 VAC • 150 W: 2 A at 115 VAC, 1.0 A at 230 VAC Output: 6.67 A
Temperature	Operating: 0 °C to +60 °C, derate linearly from 100% power at +40 °C to 50% power at +60 °C Storage: -40 °C to +85 °C
Cooling	Convection-cooled

Operating Humidity	5-95% RH, non-condensing
Operating Altitude	3000 m
Shock	30 g, 10 ms on 3 axe
Vibration	5 to 100 Hz, 2.31 m/s ² , 20 mins, 3 axes

USB flash drive specifications

Dimensions	74.99 mm x 23.29 mm x 15.90 mm (2.952" x 0.916" x 0.626")
Temperature	Operating temperature: 32 °F to 140 °F (0 °C to 60 °C) Storage temperature: -4 °F to 185 °F (-20 °C to 85 °C)
Capacity	64 GB
Formatting	FAT 32
Port compatibility	Usable with USB 3.0 and USB 2.0
Data transfer rate	<ul style="list-style-type: none"> • USB 3.0: 225 MB/s read, 135 MB/s write • USB 2.0: 30 MB/s read, 25 MB/s write

Battery kit specifications

Dimensions (W x H x D)	380 mm x 205 mm x 366 mm
Weight	5 kg

Smart battery specifications

Dimensions (W x H x D)	124 mm x 74 mm x 24.8 mm
Weight	652 g
Storage	<p>The battery can be stored in temperatures ranging from -20 °C to +60 °C at up to 80% of relative humidity.</p> <p>The optimal storage temperature is below 21 °C, in a cool, dry, and well ventilated environment. Storing a battery out of this range of temperatures may degrade its performance and reduce its life.</p>

Two-bay charger specifications

Dimensions (W x H x D)	119 mm x 38 mm x 60 mm
Weight	500 g
Voltage	<ul style="list-style-type: none"> Input voltage: 100 - 240 V AC Output voltage: 24 V
Line frequency	50 to 60 Hz
Current	<ul style="list-style-type: none"> Input current: 1.4 A (maximum) Output current: 2.7 A
Output watt	65 W

Tribrach specifications

Dimensions (W x H x D)	65 mm x 37.5 mm x 140 mm
Weight	0.680 kg
Temperature range	Operating: -20 °C to +50 °C
Tripod connection	5/8"
Spirit level	8'2 mm
Hysteresis	3cc (at 60 Ncm torsion moment and 12 kg vertical load)
Magnification	2x, erect image
Shortest focusing distance	0.35 m
Plumbing accuracy	0.5 mm/1.5 m
Eye-piece adjustment range	+/- 7 dioptre

Micro fiber lens cleaning cloth specifications

Dimensions	5" x 8" (rectangular)
Color	White or gray
Fabric	Microfiber type: Suede (ultra fine) Microfiber weave: 80/20 Edges: Unsewn - thermally welded Washable: Yes. Both sides can be used for cleaning.
Shipping Weight	1 lb

USB cable specifications

Remote device	<ul style="list-style-type: none"> Microsoft Windows™ PC or tablet running Windows 7 Home Premium or later¹ TX USB cable 2.8 meters (P/N 23704034) <p>Tablets with micro USB ports require an OTG to USB adapter.</p>
Drivers	LAN 9500 drivers for Windows x86 and x64 (Trimble TX LAN 9500 Drivers)
VNC client	RealVNC Viewer for Windows x86 and x64 (Trimble TX RealVNC Viewer)

¹ Windows RT or Windows Mobile/Phone OS not supported.

Auto-Start specifications

Dimensions (W x H x D)	19 mm x 24 mm x 20.78 mm
Weight	9 g

