

EVO Nano series

Quick Start Guide

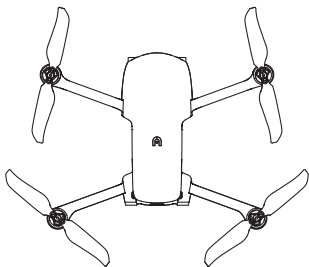

AUTEL
ROBOTICS

1 Download



Autel Sky App



Autel Sky App



2 Charge



Fully charge the aircraft batteries and remote control before flying.

3 Prepare the aircraft

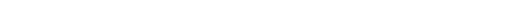
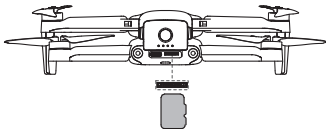
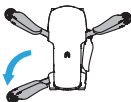
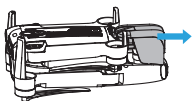

4 Prepare the remote control

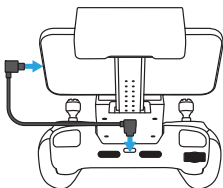
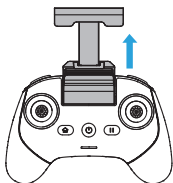

5 Power on

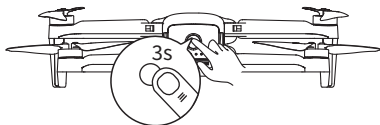

6 Start motors (Mode 2)

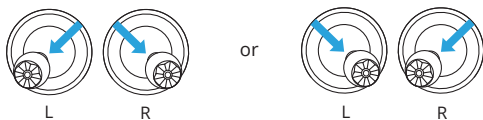

7 Take off (Mode 2)

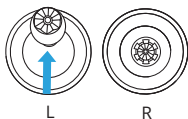

8 Landing (Mode 2)

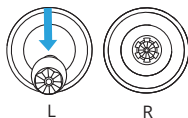

Please read all documentation before your first flight.

9 Joystick controls (Mode 2)

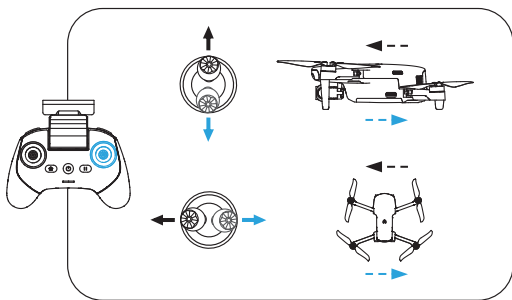
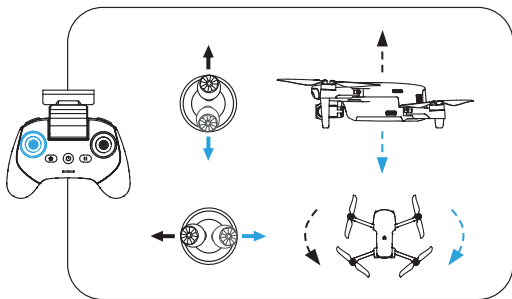

For more details, see the user manual at:
www.autelrobotics.com/download/83

Subscribe for more information

