



Precise surveying and measuring



Nedo PRIMUS 2

Fully automatic rotating lasers Made in Germany



**NEDO PRIMUS 2
SERIES**

Nedo **PRIMUS 2**, the series of fully automatic rotating lasers for professionals. Ideal for levelling, aligning and grade control. Reliable and rugged for tough construction jobs. Uncompromising quality for professionals. All **PRIMUS 2** models can be supplied with laser class 3R or laser class 2 with Bright Beam technology™.

The **PRIMUS 2** series sets a new standard for fully automatic rotating lasers. High technology made in Germany.



The Fully Automatic Rotating Lasers Made in Germany



3-year warranty for all
PRIMUS 2 models



PRIMUS 2 - The Standard for Fully Automatic Rotating Lasers



Setting Standards for Precision and Reliability

The rotating lasers of the **PRIMUS 2** series remain extraordinarily precise whatever the site conditions – in continuous rainfall, severe cold or blazing heat. Whether horizontal, vertical or at a gradient.

Always reliable, whenever and wherever they are used.

The **PRIMUS 2** casing is protected against jet water and dust in line with IP 66. After use, the **PRIMUS 2** can even be sprayed down with water to clean it.



The Standard for Ruggedness

Thanks to their innovative shock protection system, the rotating lasers of the **PRIMUS 2** series can easily withstand a fall from a height of 1 m. The thick lining and rotor protection provide additional safety.



Setting Standards for Visibility

All **PRIMUS 2** rotating lasers are fitted with high-quality laser diodes with 635 nm wavelength. The customer can choose between high-power laser diodes in laser class 3R or laser diodes in laser class 2 featuring Bright Beam Technology™ thus ensuring optimum visibility of the laser beam even under unfavourable light conditions.

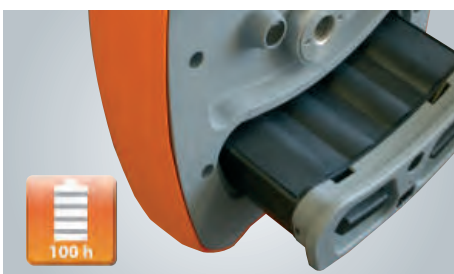

The Standard for Long Life

High-power rechargeable NiMH batteries with Eneloop™ technology ensure a long operating life of more than 100 hours, with minimal self-discharging. The intelligent power compartment permits quick changing between battery and rechargeable battery operation.



Setting Standards for Easy Operation

Are you fed up with difficult-to-handle devices?

All **PRIMUS 2** lasers feature in addition to the standard 5/8" mounting thread the Quick-Fix rapid locking system which allows the laser device to be fixed in just a few seconds to any tripod and just as quickly detached. Just throw the lever for fixing or detaching.

That's all!

Laser receiver ACCEPTOR MAXX with mm display, extra-large detector field and Heavy-Duty rod clamp

The ingeniously designed display can be seen from both the front and the side. The LEDs are extremely bright, allowing them to be read from a great distance



Nedo PRIMUS 2 H

	Ref.-No. laser class 3R	Ref.-No. laser class 2
PRIMUS 2 H Incl. transport case, laser receiver ACCEPTOR MAXX with mm display, Heavy-Duty rod clamp, Quick-Fix, rechargeable batteries and charger	472 018	472 018-632
PRIMUS 2 H Incl. transport case, Quick-Fix, rechargeable batteries and charger	472 016	472 016-632
Upgrade PRIMUS 2 H to 900 rpm	399 602	399 602

Calibration certificate for Nedo rotating lasers

Ref.-No.	399 556 calibration certificate for Nedo rotating lasers
----------	---

PRIMUS 2 H

PRIMUS 2 H available with 900 rpm.
Perfect for machine control applications.
Ref.-No. 399 602



Nedo PRIMUS 2 H

The fully automatic horizontal rotating laser

Features:

- Fully automatic rotating laser for horizontal applications
- Robust, motor-powered levelling
- Automatic level control stops the laser if it receives a heavy jolt. In this way, height errors are avoided.
- High-power laser diode, laser class 3R, for highly visible laser beam and easy work at the close range
- Alternatively available with laser class 2 with Bright Beam Technology™
- Large, clear display showing rotation speed, battery level, etc.
- Rotor protection made of break-proof glass
- Laser receiver **ACCEPTOR MAXX** with Heavy-Duty rod clamp made of diecast aluminium
- Extremely easy to use
- Highly accurate even under toughest conditions
- Available on request with a rotation speed of 900 rpm perfect for machine control applications



Scope of delivery **PRIMUS 2 H**:
Rotating laser **PRIMUS 2 H**, laser receiver
ACCEPTOR MAXX with mm display, Heavy-Duty rod clamp, rechargeable batteries and charger, Quick-Fix rapid locking system and transport case
Ref.-No. 472 018

Ideal for use on every construction site. Perfect for levelling in applications such as:

- Rough and fine grading
- Depth control for excavations
- Casting concrete
- Bricklaying
- Landscaping
- Machine control



Optional accessory "**Outdoor package**":
- Aluminium tripod, (Ref.-No. 200 225) working range 0.91 m to 1.69 m
- Flexi Rod with universal adapter and carrying bag

Ref.-No. 200 350

Nedo PRIMUS H

Technical data:	
Levelling accuracy	± 0.5 mm/10 m
Self-levelling range	± 5° motor-powered, with automatic level control
Working range Ø	approx. 700 m with receiver ACCEPTOR MAXX
Laser	< 5 mW, laser class 3R, 635 nm or < 1mW, laser class 2, 635 nm
Rotating speed	600 rpm or 900 rpm
Protection class	IP 66
Power supply	rechargeable batteries NiMH 4.8 V, 8500 mAh
Operation duration	approx. 100 h
Connecting thread	5/8"

Single slope function

For horizontal use and for slopes in one axis

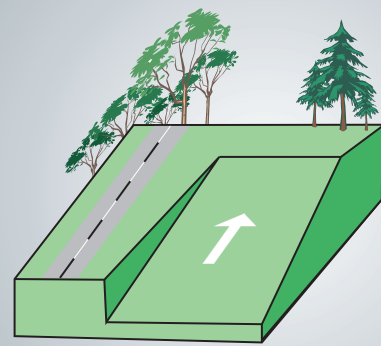

Nedo PRIMUS 2 H1N+ Long Range

	Ref.-No. laser class 3R	Ref.-No. laser class 2
PRIMUS 2 H1N+ Long Range Incl. Quick-Fix, rechargeable batteries, charger and transport case	472 025	472 025-632
PRIMUS 2 H1N+ Long Range with ACCEPTOR MAXX Incl. laser receiver ACCEPTOR MAXX, Quick-Fix, rechargeable batteries, charger and transport case	472 026	472 026-632
Upgrade PRIMUS 2 H1N+ Long Range to 750 rpm	399 604	399 604
Upgrade PRIMUS 2 H1N+ Long Range to 900 rpm	399 602	399 602

Calibration certificate for Nedo rotating lasers

Ref.-No.	399 556 calibration certificate for Nedo rotating lasers
----------	--

Optional accessory:
Telescopic sight with
laser sighting mechanism
Ref.-No. 461 096



PRIMUS 2 H1N+ Long Range

PRIMUS 2 H1N+ Long range
available with 750 rpm or 900 rpm.
Perfect for machine control
applications.

Ref.-No. 399 604 (750 rpm)
Ref.-No. 399 602 (900 rpm)



Scope of delivery **PRIMUS 2 H1N+ Long Range**:
Rotating laser **PRIMUS 2 H1N+ Long Range**,
rechargeable batteries, charger, Quick-Fix rapid
locking system and transport case
Ref.-No. 472 025



Scope of delivery **PRIMUS 2 H1N+ Long Range**
with ACCEPTOR MAXX:
Rotating laser **PRIMUS 2 H1N+ Long Range**,
laser receiver **ACCEPTOR MAXX**, rechargeable
batteries, charger, Quick-Fix rapid locking
system and transport case
Ref.-No. 472 026



Optional accessory:
Laser receiver **ACCEPTOR M**
See on page 57

Nedo PRIMUS 2 H1N+ Long Range

Fully automatic single slope laser with tilt control and automatic re-levelling when in slope mode. Extremely large working range for use with machine control applications.

Features:

- Fully automatic single slope laser
- Robust, motor-powered levelling
- Direct grade entry for the y axis
- Slope value once input is stored beyond switch-off
- Tilt control: the position of the laser plane is continuously monitored in the slope mode and re-levelled if necessary.
- Automatic level control stops the laser if it receives a heavy jolt. In this way, height errors are avoided.
- Large, clear display showing inclination, rotation speed, battery level, etc.
- High-power laser diode, laser class 3R
- Alternatively available with laser class 2 with Bright Beam Technology™
- Rotor protection made of break-proof glass
- Highly accurate even under toughest conditions
- **PRIMUS 2 H1N+ Long Range** available on request with a rotation speed of 750 or 900 rpm perfect for machine control applications

Ideal for use on every construction site. Perfect for levelling in applications such as:

- Machine control
- Elevation control
- Rough and fine grading
- Depth control for excavations
- Casting concrete
- Bricklaying
- Setting foundations and footings
- Landscaping

Nedo PRIMUS 2 H1N+ Long Range

Technical data:	
Levelling accuracy	± 0.5 mm/10 m
Self-levelling range	± 5° motor-powered, with automatic level control
Setting of slope function	± 10 %
Accuracy of the slope function	better than ± 0,015 %
Working range Ø	approx. 1000 m with excavator receiver
Laser	< 5 mW, laser class 3R, 635 nm or < 1mW, laser class 2, 635 nm
Rotating speed	600 rpm, 750 rpm or 900 rpm
Protection class	IP 66
Power supply	rechargeable batteries NiMH 4.8 V, 8500 mAh
Operation duration	approx. 100 h
Connecting thread	5/8"

mm display

Supplied as standard with laser receiver COMMANDER 2 with mm display and practically indestructible all-metal clamp made of diecast aluminium



Dual slope function
For horizontal use and for slopes in one or two axes

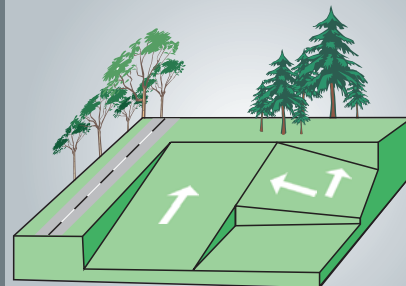

Nedo PRIMUS 2 H2N+ / PRIMUS 2 H2N

	Ref.-No. laser class 3R	Ref.-No. laser class 2
PRIMUS 2 H2N+ with tilt control Incl. multi-function module COMMANDER 2 H2N+ (laser receiver incl. radio remote control) with mm display, Heavy-Duty rod clamp, Quick-Fix, rechargeable batteries, charger and transport case	472 034	472 034-632
PRIMUS 2 H2N+ with tilt control Incl. laser receiver ACCEPTOR MAXX , Heavy-Duty rod clamp, Quick-Fix, rechargeable batteries, charger and transport case	472 037	472 037-632
PRIMUS 2 H2N+ with tilt control Incl. Quick-Fix, rechargeable batteries, charger and transport case	472 033	472 033-632
Upgrade PRIMUS 2 H2N+ auf 750 rpm	399 604	399 604
Upgrade PRIMUS 2 H2N+ auf 900 rpm	399 602	399 602
PRIMUS 2 H2N Incl. multi-function module COMMANDER 2 H2N (laser receiver incl. radio remote control) with mm display, Heavy-Duty rod clamp, Quick-Fix, rechargeable batteries, charger and transport case	472 031	472 031-632
PRIMUS 2 H2N Incl. laser receiver ACCEPTOR MAXX , Heavy-Duty rod clamp, rechargeable batteries, charger and transport case	472 036	472 036-632
PRIMUS 2 H2N Incl. Quick-Fix, transport case, rechargeable batteries and charger	472 030	472 030-632

Calibration certificate for Nedo rotating lasers

Ref.-No.	399 556 calibration certificate for Nedo rotating lasers
----------	--

Optional accessory:
Telescopic sight with
laser sighting mechanism

Ref.-No. 461 096



PRIMUS 2 H2N+

PRIMUS 2 H2N+ available
with 750 or 900 rpm.
Perfect for machine control
applications.

Ref.-No. 399 604 (750 rpm)
Ref.-No. 399 602 (900 rpm)



Nedo PRIMUS 2 H2N+

Fully automatic dual slope laser with tilt control and automatic re-levelling when in slope mode.

Nedo PRIMUS 2 H2N

Fully automatic dual slope laser



Scope of delivery **PRIMUS 2 H2N+**:
Rotating laser **PRIMUS 2 H2N+**, laser
receiver **COMMANDER 2 H2N+ with mm
display**, Heavy-Duty rod clamp, rechargeable
batteries, charger, Quick-Fix rapid locking
system and transport case

Ref.-No. 472 034-632

Features:

- Fully automatic dual slope laser
- Robust, motor-powered levelling
- Direct grade entry for the x and y axes
- Slope values once input are stored beyond switch-off
- **PRIMUS 2 H2N+** with tilt control: the position of the laser plane is continuously monitored in the slope mode and re-levelled if necessary.
- Automatic level control stops the laser if it receives a heavy jolt. In this way, height errors are avoided.
- Large, clear display showing inclination, rotation speed, battery level, etc.
- High-power laser diode, laser class 3R, for highly visible laser beam and easy work at the close range
- Alternatively available with laser class 2 with Bright Beam Technology™
- Rotor protection made of break-proof glass
- Highly accurate even under toughest conditions
- **PRIMUS 2 H2N+** available on request with a rotation speed of 750 or 900 rpm perfect for machine control applications

Ideal for use on every construction site. Perfect for levelling in applications such as:

- Elevation control
- Rough and fine grading
- Depth control for excavations
- Machine control
- Casting concrete
- Bricklaying
- Setting foundations and footings
- Landscaping



Optional accessory "**Optional accessory**":

- Aluminium tripod, (Ref.-No. 200 225)
working range 0.91 m to 1.69 m
- Flexi Rod with universal adapter and carrying
bag

Ref.-No. 200 350

Nedo PRIMUS 2 H2N+ and H2N

Technical data:	
Levelling accuracy	± 0.5 mm/10 m
Self-levelling range	± 5° motor-powered, with automatic level control
Setting of slope function	± 10%, direct entry
Accuracy of the slope function	± 0.015% PRIMUS 2 H2N+, ± 0.1% PRIMUS 2 H2N
Working range Ø	approx. 700 m with receiver COMMANDER 2 H2N
Laser	< 5 mW, laser class 3R, 635 nm or < 1mW, laser class 2, 635 nm
Rotating speed	600 rpm, 750 rpm or 900 rpm (H2N+)
Protection class	IP 66
Power supply	rechargeable batteries NiMH 4.8 V, 8500 mAh
Operation duration	approx. 100 h
Connecting thread	5/8"



AutoAlign Video

AutoAlign function

At the push of a button, the laser plane automatically aligns with the laser receiver **COMMANDER 2 HVA**. Ideal when batter boards are used or on facade construction. The working range of the AutoAlign function is 50 metres.

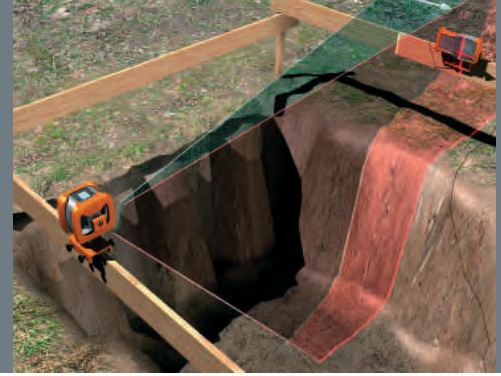

Nedo PRIMUS 2 HVA

The fully automatic horizontal/vertical rotating laser with AutoAlign function



Scope of delivery **PRIMUS 2 HVA**:

Rotating laser **PRIMUS 2 HVA**, laser receiver **COMMANDER 2 HVA with mm display**, Heavy-Duty rod clamp, rechargeable batteries, charger, Quick-Fix rapid locking system and transport case
Ref.-No. 472 050-632

Features:

- Fully automatic rotating laser for horizontal and vertical applications
- AutoAlign function: automatic alignment of the laser beam to the zero mark of the laser receiver
- Robust motor-powered levelling
- Large, clear display showing rotation speed, battery level, etc.
- Automatic level control stops the laser if it receives a heavy jolt. In this way, height errors are avoided.
- Manual setting of slopes in 2 axes
- Scan function and dot mode
- High-power laser diode, laser class 3R, for highly visible laser beam and easy work at the close range
- Alternatively available with laser class 2 with Bright Beam Technology™
- Upward plumb beam
- Rotor protection made of break-proof glass
- Highly accurate even under toughest conditions
- Incl. multi-function module **COMMANDER 2 HVA**, laser receiver incl. radio remote control

Ideal for interior applications. Perfect for levelling and aligning jobs, especially in the following areas:

- Depth control for excavations
- Concrete casting
- Concrete formwork
- Use of batter boards
- Bricklaying
- Laying screed
- Drywall installation
- Ceiling construction
- Facade construction



Optional accessory **“Accessory package 1”**:

- Elevating tripod, (Ref.-No. 210 621) working range 0.80 m to 2.76 m
- Flexi Rod with universal adapter and carrying bag

Ref.-No. 210 350

Optional accessory **“Accessory package 2”**:

- Elevating tripod, (Ref.-No. 210 616) working range 0.78 m to 2.03 m
- Flexi Rod with universal adapter and carrying bag

Ref.-No. 210 351

Nedo PRIMUS 2 HVA

Technical data:	
Levelling accuracy	± 0.5 mm/10 m
Self-levelling range	± 5° motor-powered, with automatic level control
Setting of slopes in two axes	manual
Working range Ø	approx. 500 m with receiver COMMANDER 2 HVA
Laser	< 5 mW, laser class 3R, 635 nm or < 1mW, laser class 2, 635 nm
Working range radio remote control	approx. 150 m
Working range AutoAlign	approx. 50 m
Rotating speed	10, 60, 300 and 600 rpm
Scanning angle	0°, 5°, 10° and 15°
Protection class	IP 66
Power supply	rechargeable batteries NiMH 4.8 V, 8500 mAh
Operation duration	approx. 100 h
Connecting thread	5/8"

mm display

Supplied as standard with laser receiver COMMANDER 2 with mm display and practically indestructible all-metal clamp made of diecast aluminium



Dual slope function
For horizontal use and for slopes in one or two axes

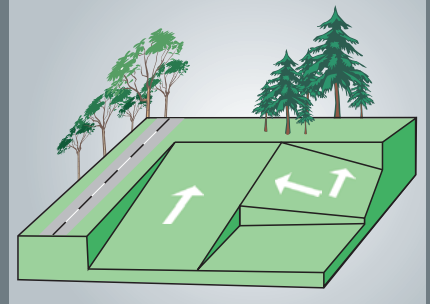

Nedo PRIMUS 2 HVA2N

	Ref.-No. laser class 3R	Ref.-No. laser class 2
--	-------------------------	------------------------

PRIMUS 2 HVA2N	472 061	472 061-632
Incl. multi-function module COMMANDER 2 HVA2N (laser receiver incl. radio remote control) with mm display, Heavy-Duty rod clamp, Quick-Fix, rechargeable batteries, charger and transport case		

Calibration certificate for Nedo rotating lasers

Ref.-No.	399 556 calibration certificate for Nedo rotating lasers
----------	--

Vertical alignment aid
In vertical operation the laser can be exactly aligned with the help of a laser line

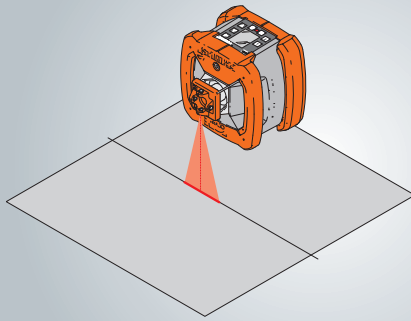

AutoAlign function
At the push of a button, the laser plane automatically aligns with the laser receiver **COMMANDER 2 HVA2N**.
Ideal when batter boards are used or on facade construction.



Nedo PRIMUS 2 HVA2N

The fully automatic horizontal/vertical dual slope laser with AutoAlign function



Scope of delivery **PRIMUS 2 HVA2N**:
Rotating laser **PRIMUS 2 HVA2N**, laser receiver **COMMANDER 2 HVA2N with mm display**, Heavy-Duty rod clamp, rechargeable batteries, charger, Quick-Fix rapid locking system and transport case
Ref.-No. 472 061-632

Features:

- Fully automatic rotating laser for horizontal and vertical applications
- Direct grade entry for the x and y axis
- Tilt control: the position of the laser is continuously monitored in the tilt mode
- AutoAlign function: automatic alignment of the laser beam to the zero mark of the laser receiver
- Robust motor-powered levelling
- Large, clear display showing inclination, rotation speed, battery level, etc.
- Automatic level control stops the laser if it receives a heavy jolt. In this way, height errors are avoided.
- High-power laser diode, laser class 3R, for highly visible laser beam and easy work at the close range
- Alternatively available with laser class 2 with Bright Beam Technology™
- Scan function and dot mode
- Upward plumb beam
- Rotor protection made of break-proof glass
- Highly accurate even under toughest conditions
- Incl. multi-function module **COMMANDER 2 HVA2N**, laser receiver incl. radio remote control

Ideal for use on every construction site. Perfect for levelling in applications such as:

- Depth control for excavations
- Concrete casting
- Setting foundations and footings
- Concrete casting
- Use of batter boards
- Bricklaying
- Landscaping
- Laying screed
- Facade construction
- Setting reference markers
- Rough and fine grading
- Ceiling construction



Optional accessory "Accessory package 1":

- Elevating tripod, (Ref.-No. 210 621)
working range 0.80 m to 2.76 m
- Flexi Rod with universal adapter and carrying bag

Ref.-No. 210 350

Optional accessory "Accessory package 2":

- Elevating tripod, (Ref.-No. 210 616)
working range 0.78 m to 2.03 m
- Flexi Rod with universal adapter and carrying bag

Ref.-No. 210 351

Nedo PRIMUS 2 HVA2N

Technical data:	
Levelling accuracy	± 0.5 mm/10 m
Self-levelling range	± 5° motor-powered, with automatic level control
Accuracy of the slope function	± 0.015%
Setting of slopes in two axes	± 10%, direct entry
Working range Ø	approx. 700 m with receiver COMMANDER 2 HVA2N
Laser	< 5 mW, laser class 3R, 635 nm or < 1mW, laser class 2, 635 nm
Working range radio remote control	approx. 150 m
Working range AutoAlign	approx. 50 m
Rotating speed	10, 60, 300 and 600 rpm
Scanning angle	0°, 5°, 10° and 15°
Protection class	IP 66
Power supply	rechargeable batteries NiMH 4.8 V, 8500 mAh
Operation duration	approx. 100 h
Connecting thread	5/8"



Nedo Facade Construction Adapters

The **Facade Construction Adapters** are fastened to the wall and horizontally aligned with the aid of integrated bubbles. Thanks to the mm graduations provided on the traverses, rotating lasers and laser receivers can be conveniently positioned at the required distance from the wall. The new **Facade Construction Adapters** have been optimally matched to the fully automatic PRIMUS 2 HVA and PRIMUS 2 HVA2N rotating lasers with AutoAlign function and to the COMMANDER 2 laser receiver, and provide in combination with these instruments a professional and complete system for facade construction.

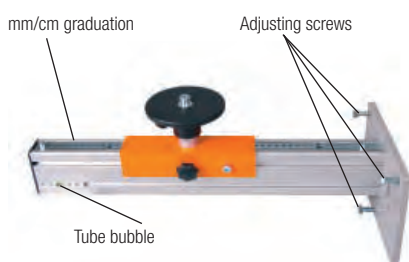

Facade Construction Adapter for PRIMUS 2 Rotating Lasers

Sturdy aluminium **facade construction adapter**. Sliding runner with tripod head and 5/8" connecting thread. Adjusting range approx. 450 mm.

Three adjusting screws allow exact alignment of the **facade construction adapter**.

Ref.-No. 461 046

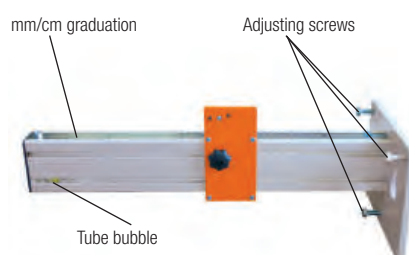

Facade Construction Adapter for COMMANDER 2 Laser Receivers

Sturdy aluminium **facade construction adapter**. Sliding runner for accommodating the COMMANDER 2 laser receiver. Adjusting range approx. 490 mm.

Three adjusting screws allow exact alignment of the **facade construction adapter**.

Ref.-No. 461 056

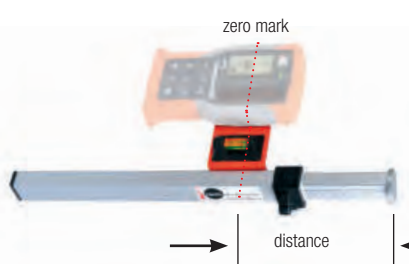

Mini-Flexi Rod for Facade Construction

The mini-flexi rod allows distances in facade construction to be measured quickly and easily. Measurement range: 65 mm to 280 mm

Ref.-No. 461 048





Nedo Batter Board Holder

On modern construction sites the batter board is increasingly being supplanted by a rotating laser. The laser is, in vertical operation, placed on a **batter board holder** fastened to the batter board by a clamping screw. The **batter board holder** is provided with a turntable allowing rough alignment of the rotating laser.

The laser receiver with the receiver holder is clamped on the opposite side of the batter board. Thanks to the AutoAlign function, the laser plane automatically aligns with the laser receiver in the case of the PRIMUS 2 HVA and PRIMUS 2 HVA2N models. Furthermore, the laser plane is automatically monitored and if necessary corrected by the AutoAlign function.



Batter Board Holder for Rotating Lasers PRIMUS 2

Sturdy aluminium **batter board holder** with four clamping screws. Suitable for use with rotating lasers from the PRIMUS 2 series.

clamping range: 18 - 85 mm

Ref.-No. 461 051

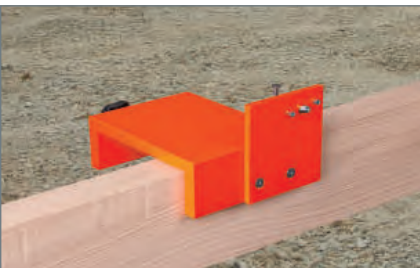

Batter Board Holder for Laser Receiver COMMANDER

Sturdy aluminium **batter board holder** with one clamping screw. Suitable for use with COMMANDER 2 laser receiver.

clamping range: 18 - 90 mm

Ref.-No. 461 055



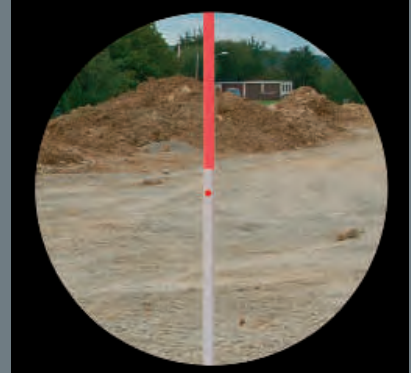

Nedo Accessories PRIMUS 2



Telescopic Sight

The use of dual-axis slope lasers requires an extremely exact alignment of the laser axes. With the help of the PRIMUS 2 **telescopic sight** with integrated target laser the laser axis can be precisely aligned to the target even if it is a great distance away. The **telescopic sight** can easily be fixed to the PRIMUS 2 without any tools. Suitable for use with the slope lasers PRIMUS 2 H1N+, H2N, H2N+ and HVA2N.

Ref.-No. 461 096



Nedo Multifunctional Base

Rugged base with fine adjustment. Perfect for axis alignment of slope lasers such as Nedo PRIMUS 2 H1N+, H2N, H2N+ and HVA2N.

Ref.-No. 062 579



PRIMUS 2 Battery Charger Add-On Kit

Spare battery and charger, can be used for all PRIMUS 2 models.

Ref.-No. 461 098

PRIMUS 2 Battery Box

Battery box for 4 x 1.5 V mono-cells, can be used for all PRIMUS 2 models.

Ref.-No. 461 097

Quick-Fix rapid locking system

Rapid setting with 6 arresters or fine adjustment for exact gradient setting

Circular bubble

Supporting disc, flat
ø 110 mm

Scale:
0 to 100% in 5% steps and
0 to 90° in 5° steps

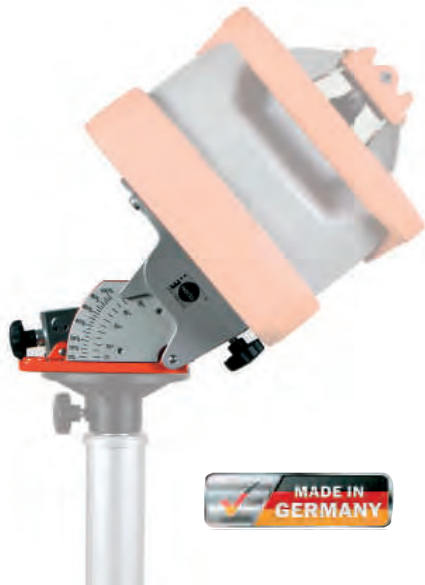

Nedo Tilt Adapter

With the **tilt adapter**, inclines of up to 90° can be set manually. Quick adjustment with 6 stages and additional fine adjustment. Scale with % and ° units. Ideal for creating slopes or refurbishing roofs.

Incl. circular level, built-in sighting device, 5/8" connecting thread and Quick-Fix system.

Features:

- Accuracy: $\pm 1^\circ$
- Coarse and fine adjustment for quick height settings
- Integrated Quick-Fix system for all lasers in the PRIMUS 2 series
- 5/8" thread for all rotating lasers
- Scale with degree and percent graduations
- Made of high-quality cast aluminium

Ref.-No. 461 047

Nedo Laser Accessories

Outdoor Package for PRIMUS 2 Series

- Aluminium tripod, working range 0.91 m to 1.69 m Ref.-No. 200 225
- Flexi Rod with universal adapter and carrying bag

Ref.-No. 200 350

Accessory Package 1 for PRIMUS 2 Series

- Elevating tripod, working range 0.80 m to 2.76 m Ref.-No. 210 621
- Flexi Rod with universal adapter and carrying bag

Ref.-No. 210 350

Accessory Package 2 for PRIMUS 2 Series

- Elevating tripod, working range 0.78 m to 2.03 m Ref.-No. 210 616
- Flexi Rod with universal adapter and carrying bag

Ref.-No. 210 351





Nedo laser receivers COMMANDER 2 are equipped with the new, practically indestructible Heavy-Duty rod clamp as a standard.

mm display

Nedo Laser Receiver for Rotating Lasers PRIMUS 2

Nedo COMMANDER 2 with mm display

Extremely robust laser receiver with integrated radio remote control for rotating lasers of the PRIMUS 2 series.

With the mm display, height differences during levelling can be read off directly – without calculation.



Features:

- Robust laser receiver incl. radio remote control for PRIMUS 2 rotating lasers
- Large detector field of 70 mm length
- Readout of height difference in mm
- Large illuminated LC displays on the front and back
- Size of directional arrows is proportional to difference in height
- Bright LED display
- 4 accuracy settings: $\pm 0,5$ mm, ± 1 mm, ± 2 mm and ± 4 mm
- Battery status shown in display
- Adjustable volume
- Bubble for easy alignment
- Automatic shut-off after 15 min.
- Protected against splash and dust to IP 66
- Power supply: 3 x 1,5 V (AA)
- Operation duration: up to 100 h
- Supplied with Heavy-Duty rod clamp and batteries as a standard



Technical data:

Accuracy switchable,	± 0.5 mm, ± 1 mm, ± 2 mm and ± 4 mm
Working range	\emptyset 700 m (depends on laser)
Length of detector field	70 mm
Reception angle	$\pm 50^\circ$
Protection class	IP 66
Operating temperature	-20°C to +50°C
Power supply	3 x 1.5 V batteries (AA) or rechargeable batteries (NiMH)
Operation duration	up to 100 h

Ref.-No. 430 370 COMMANDER 2 HVA

Ref.-No. 430 371 COMMANDER 2 H2N

Ref.-No. 430 374 COMMANDER 2 H2N+

Ref.-No. 430 375 COMMANDER 2 HVA2N



Nedo ACCEPTOR MAXX

Nedo **ACCEPTOR MAXX** is a new digital laser receiver with a mm display and an extra-large detector field. The robust housing and virtually indestructible Nedo heavy-duty rod clamp make the new **ACCEPTOR MAXX** perfect for use under harsh conditions.

Large illuminated digital LC displays on the front and back show the deviation of the zero line of the **ACCEPTOR MAXX** from the plane of the rotation laser. The easy-to read displays allow you to read off height differences directly in mm, without calculation.

In addition, extremely bright LEDs show the position of the laser receiver in relation to the laser plane. The ingeniously designed housing allows the LEDs to be seen from the front and the side, even from a great distance. Furthermore, an acoustic signal indicates the position of the laser receiver.

ACCEPTOR MAXX

MAXXimum detector field

- Detector field with 120 mm length

MAXXimum performance

- Double LED display in front and side
- Illuminated displays

MAXXimum working range

- Working diameter 900 m

MAXXimum precision

- Digital mm display up to ± 52 mm

Features:

- Robust laser receiver for all rotating lasers with a red laser beam
- Extra-large 120 mm detector field
- Large illuminated LC displays on the front and back
- Readout of height difference in mm
- Size of directional arrows is proportional to difference in height
- Bright LED display, visible the front and side
- 4 accuracy settings: ± 1 mm, ± 2 mm, ± 4 mm and ± 8 mm
- Energy-saving mode, display illumination can be switched off
- Battery status shown in display
- Switchable acoustic signal
- Bubble for easy alignment
- Automatic shut-off after 15 min.
- Nedo heavy-duty rod clamp and batteries supplied as standard

Nedo ACCEPTOR MAXX

Ref.-No.	430 339
Accuracy	± 1 mm, ± 2 mm, ± 4 mm and ± 8 mm
Working range	\varnothing 900 m (depends on laser)
Length detector field	127 mm
Reception angle	$\pm 45^\circ$
Protection class	IP 67
Operating temperature	-20°C to +60°C
Power supply	2 x 1.5 V type mignon (AA)
Operation duration	approx. 60 h





Precise surveying and measuring

Nedo GmbH & Co. KG

Hochgerichtstrasse 39-43
D-72280 Dornstetten

Phone +49 (0) 7443 24 01-0
Fax +49 (0) 7443 24 01-45

info@nedo.com
www.nedo.com

