



Mobile Laser Scanning System User Guide

Contents

Copyright.....	1
1 Safety Tips.....	2
1.1 Overview	2
1.2 Scope of Application	2
1.3 Restrictions	3
1.4 Responsibilities	3
1.5 Risks Present in Operations	3
1.6 Laser Classification	5
1.6.1 Overview	5
1.6.2 Laser Beam	5
1.7 Battery Operation	6
2 Product Introduction	7
2.1 Product Name and Composition	7
2.2 Key Specifications	7
3 System Description	9
3.1 Packing List	9
3.1.1 LiMobile M1 Packing List	9
3.1.2 LiMobile M1 Packing List (without the Ladybug5+ panoramic camera).....	10
3.2 Laser Scanner	12
3.3 Planar Camera	12
3.4 Panoramic Camera	12
3.5 Inertial Navigation System	13
3.6 Wi-Fi Information	13
4 LiMobile M1 Data Collection Requirements	14
4.1 Weather Conditions	14
4.2 Collection Time	14
4.3 Collection Route	14
5 Preparation and Precautions For Data Collection	18
5.1 Pre-Project Preparation	18
5.2 Mounting the System Precautions	18
5.3 System Operations Precautions	18
6 LiMobile M1 Installation	19
6.1 Push Pull Bracket Installation	19
6.2 Luggage Rack Crossbar Installation	19
6.3 Pull Out and Fix the Push Pull Bracket	20
6.4 Integrated Equipment Installation	20
*6.5 LiMobile M1 Main Body and GNSS Antenna Installation	21
6.6 GNSS Feeder Cable Connection	21
6.7 Wi-Fi Stick Antenna and Battery Installation	21
6.8 Power Cable and Ethernet Cable Connection	22
6.9 LiMobile M1 Installation Completed	22

7 LiMobile M1 Operation Procedure	23
7.1 Base Station Setup	23
7.1.1 Base Station Installation	23
7.1.2 Device Connection	23
7.1.3 Coordinate System Setting	24
7.1.4 Static Recording	24
7.2 Device Power On	25
7.3 Device Connection	25
7.3.1 Connecting To the LiMobile User Interface via Wi-Fi	25
7.3.2 Connecting To the LiMobile User Interface via Ethernet Cable	25
7.4 Data Collection	26
7.4.1 Confirm the Sensor Status	26
7.4.2 New Project	27
7.4.3 Device Initialization	27
7.4.4 INS Alignment	28
7.4.5 Start Data Recording	28
7.4.6 Data Collection	29
7.4.7 Stop Data Recording	31
7.4.8 INS Alignment	32
7.4.9 Close the Project	32
7.5 Device Power Off	34
7.6 Battery Charging	34
8 Data Processing Procedure	35
8.1 Data Copy	35
8.1.1 Data Copy Method	35
8.1.2 Data Integrity Check	37
8.2 Data Processing	37
8.2.1 Open Project	37
8.2.2 Project Settings	38
8.2.3 POS Processing	42
8.2.4 Point Cloud Processing	44
8.3 Point Cloud Quality Inspection and Improvement	44
8.3.1 Point Cloud Quality Inspection	45
8.3.2 Point Cloud Quality Improvement	45
8.4 Point Cloud and Planar Image Overlay Display	47
8.5 Point Cloud and Panoramic Image Fusion Quality Inspection	47
8.5.1 Quality Inspection	47
8.5.2 Point Cloud Colorization	48
9 Frequently Asked Questions	50
10 Appendix	52

Copyright

GreenValley International Inc. (GVI) reserves all right for final explanation, and at its sole discretion, to change, modify, and remove portions of this document.

No Part of this document may be reproduced or transmitted in any form or by any means, electronic, mechanical, photocopying, recording, or otherwise, without prior written permission of GreenValley International Inc.

GreenValley International Inc.

729 Heinz Avenue, Suite 9

Berkeley, CA 94710

USA

+1 510.345.2899

info@greenvalleyintl.com





www.greenvalleyintl.com

1 Safety Tips

1.1 Overview

Description | The following instructions delineate the roles and responsibilities of the individual overseeing the product and the end user of the equipment, as well as provide guidance on preventing and mitigating potentially hazardous operations.
 Before using the equipment, please carefully read this manual and adhere to the operational guidelines provided within. This manual will be updated in real-time as the product technology advances. Users can obtain the latest “LiMobile M1 Mobile Laser Scanning System User Guide” through the official website of GVI. or GVI technicians.

Warning Message | Warning messages are an integral part of the basic safety concept of the instrument. It informs in advance of potential safety hazards and dangerous situations that may occur.
 • Alert users to potential direct or indirect safety hazards associated with the instrument's use.
 • Provide general operating guidelines.
 For the sake of user safety, users must strictly adhere by the safety instructions.
 ‘DANGER’, ‘WARNING’, ‘CAUTION’, and ‘NOTE’ are standardized signal words used to identify hazards and levels of risk with respect to personal injury and property damage. To ensure your safety, it is essential to read and thoroughly comprehend the various signal words and their corresponding definitions presented in the table below.

Type	Illustrate
 Danger	Indicates a potentially hazardous situation that, if not avoided, will result in death or serious injury.
 Warning	Indicates a potentially hazardous situation or improper handling that, if not avoided, could result in death or serious injury.
 Caution	Indicates a potentially hazardous situation or incorrect operation that, if not avoided, may result in minor or moderate injury.
Note	Indicates a potentially hazardous situation or improper operation that, if not avoided, may result in economic loss and environmental damage.
	Indicates important chapters that must be followed during actual use to correctly and effectively use the product

1.2 Scope of Application

- Scope of Usage**
- Scan the 3D environment
 - Capture images
 - Collected georeferenced data
 - Extract features
 - Measure distance

Foreseeable misuse	<ul style="list-style-type: none"> • Use of the LiMobile M1 not in accordance with the guide • Use of the product outside its intended use and limitations • Ignoring hazard warnings • Using tools such as screwdrivers to disassemble, repair or modify the product outside the scope of specific permits • Continuing to use the product after mishandling • Use accessories produced by other manufacturers without the prior express written consent of GVI. • Insufficient workplace safety measures
---------------------------	---



1.3 Restrictions







Environment	<p>Suitable for use in an environment suitable for permanent human habitation. Not suitable for use in corrosive or explosive atmospheres.</p> <p> Warning</p> <p>Working in geographically hazardous areas, near electrical installations, or similar locations poses a risk to life.</p> <p>Prevention:</p> <ul style="list-style-type: none"> ▶ It is necessary to ensure the safety of the working site environment.
Indoor Charger Environmental Conditions	<p>Suitable for use in dry environments, not for use in harsh conditions.</p>





1.4 Responsibilities

Manufacturer	<p>GVI is responsible for the products provided, including user guide and original accessories, under safe use conditions.</p>
Person in charge of equipment	<p>The person in charge of the equipment has the following responsibilities:</p> <ul style="list-style-type: none"> • Master the safety instructions and operation methods in the user guide • Make sure to operate the equipment according to the manual • If there are security problems in products and applications, please stop the operating system immediately and notify GVI • Ensure compliance with national laws, regulations and operating conditions regarding the operation of this product

1.5 Risks Present in Operations

	<p> Warning</p> <p>Dismantling parts of LiMobile M1 at will may cause malfunction.</p> <p>Prevention:</p> <ul style="list-style-type: none"> ▶ In order to avoid equipment damage and violation of warranty terms, please do not disassemble the equipment at will. If the product fails, it must be repaired by qualified maintenance personnel authorized by Beijing Digital Green Earth Technology Co., Ltd. ▶ Do not modify the cables.
	<p> Warning</p> <p>Components of the LiMobile M1 exceeding the maximum permitted</p>

	<p>speed may fall from the vehicle. Prevention:</p> <ul style="list-style-type: none"> ▶ Do not exceed a speed of 120 km/h; it is recommended to travel at speeds below 80 km/h.
	<p> Warning</p> <p>Accidents caused by driver distraction due to operating this equipment system while driving can result in significant property damage and serious injuries or fatalities. Prevention:</p>
	<p> Warning</p> <p>Damaged battery compartments can lead to short circuits, battery acid leaks, and exposure to toxic substances. This damage can cause bodily injury, chemical burns or even death. Prevention:</p> <ul style="list-style-type: none"> ▶ Stop using damaged batteries.
	<p> Warning</p> <p>Lightning. Prevention:</p> <ul style="list-style-type: none"> ▶ Do not use LiMobile M1 during rain or thunderstorms
	<p> Warning</p> <p>Inadequate safety assurance for surveying and mapping tasks can lead to dangerous situations, such as traffic accidents. Prevention:</p> <ul style="list-style-type: none"> ▶ Always ensure working conditions with adequate safeguards. ▶ Always abide by the safety and accident prevention management regulations in the traffic rules.
	<p> Warning</p> <p>Failure to secure components properly may result in mechanical collisions with the equipment, potentially causing damage to the instruments or injury to personnel. Prevention:</p> <ul style="list-style-type: none"> ▶ When installing the device, make sure that the accessories are properly adjusted and secured, and that the cables are installed and locked in place. ▶ Protect the equipment from mechanical damage. ▶ When transporting the equipment, please be sure to properly place all items in the protective box, and do not transport or move the product equipment that is not in a protected state.
	<p> Warning</p> <p>If the vents are blocked while charging, it may cause the charger to overheat and cause a fire. Prevention:</p> <ul style="list-style-type: none"> ▶ Please make sure that the vents are not blocked when using the charger.
	<p> Warning</p> <p>Used in wet and harsh environments, if the components get wet, it may cause electric shock.</p>

	<p>Prevention:</p> <ul style="list-style-type: none"> ▶ Do not use wet products. ▶ Use this product only in dry environments. ▶ Protect this product from moisture.
	<p> Caution</p> <p>The maximum load on the roof equipment has been exceeded.</p> <p>Prevention:</p> <ul style="list-style-type: none"> ▶ The weight of equipment mounted on the roof of the vehicle must not exceed the maximum load specified for the vehicle used.
	<p> Caution</p> <p>The maximum height constraint is ignored.</p> <p>Prevention:</p> <ul style="list-style-type: none"> ▶ Pay attention to height restrictions when driving into garages, tunnels or under bridges.
	<p> Caution</p> <p>The accessories are loose.</p> <p>Prevention:</p> <ul style="list-style-type: none"> ▶ Check for loose mounting screws. Vibration can be one of the causes of loose screws. ▶ Check the installation within 30 minutes of first installation or within 50 km of the working location. ▶ Repeat the installation inspection every 500 km.
	<p> Caution</p> <p>The tablet was thrown in the car.</p> <p>Prevention:</p> <ul style="list-style-type: none"> ▶ Please keep the tablet in place while driving.
	<p>Attention</p> <p>The product has been accidentally dropped, abused, altered, stored or transported for long periods of time.</p> <p>Prevention:</p> <ul style="list-style-type: none"> ▶ Regularly test, especially before and after abnormal use or important work.

1.6 Laser Classification

1.6.1 Overview

Overview







- ☞ According to IEC TR 60825-14 (2004-02), Class 1, Class 2 and Class 3R laser products do not require:
 - Laser safety personnel involved
 - Wear protective clothing and eye protection
 - Special warning signs in the work area

The risk of harm to eyes is relatively low when used and operated according to the user guide.
- ☞ Your local laws and regulations may be stricter than IEC 60825-1 (2014-05) and IEC TR 60825-14 (2004-02).

1.6.2 Laser Beam

Conventional	<p>The product emits a visible beam of light from a rotating mirror. The laser product described in this section is classified as a Class 1 laser product according to the following criteria: IEC 60825-1 (2014-05): ‘Laser Product Safety’.</p> <p>These products are safe under suitable conditions and will not damage the eyes. It should be used and maintained according to the manual.</p>
Reference	<p>Please refer to the scanner OEM's data sheet for more setting parameters</p> <ul style="list-style-type: none"> • Manufacturer: Hesai Technology • Model: XT32

1.7 Battery Operation

	<p> Warning</p> <p>In humid environmental conditions, the battery box's wiring may experience a short circuit.</p> <p>Prevention:</p> <ul style="list-style-type: none"> ▶ Do not place the battery system in water, or expose it to moisture, lubricants, solvents, or any other liquids. Outdoor use should protect the battery from rain.
	<p> Warning</p> <p>Damaged batteries and battery compartment will cause combustion, explosion, poisoning, corrosion and environmental pollution. If the skin or eyes come into direct contact with the electrolyte leaked from the battery, wash it thoroughly with clean water and contact a doctor immediately.</p> <p>Prevention:</p> <ul style="list-style-type: none"> ▶ Protect the battery from mechanical damage. ▶ If the battery compartment is damaged, switch off all operating charging devices. ▶ If any electrolyte leaks from a damaged battery, avoid skin contact and direct inhalation of gas.
	<p> Warning</p> <p>Charging above the temperature limit may damage the battery.</p> <p>Prevention:</p> <ul style="list-style-type: none"> ▶ Pay attention to the temperature limit when charging.
	<p> Warning</p> <p>Risk of fire due to overheating of battery surfaces during charging.</p> <p>Prevention:</p> <ul style="list-style-type: none"> ▶ Charge the battery only on non-flammable surfaces. ▶ Master the correct usage of batteries.
	<p> Caution</p> <p>Long-term storage may reduce life or damage the battery.</p> <p>Prevention:</p> <ul style="list-style-type: none"> ▶ During long-term storage, charge regularly to maintain battery life. ▶ If it will not be used for a long time or transported for a long distance, please take out the power supply battery from the battery compartment. <p>In addition to these selected warnings, the full user guide must be followed.</p>

2 Product Introduction

The LiMobile M1 mobile laser scanning(MLS) system is equipped with a 45-degree tilted LiDAR, a high-resolution camera, and a Ladybug5+ panoramic camera, which can quickly obtain 3D data of the road and surrounding features. At the same time, it provides abundant expansion interfaces, supporting optional accessories such as the distance measurement indicator(DMI). It also supports a 2 TB hard drive, facilitating storage and copying of large data volumes. The integrated vehicle mount design allows for installation in different vehicle types. Together with LiDAR360 MLS software from GVI, it enables a one-stop data processing for the delivery of industry results.

For detailed technical information about the LiMobile M1 mobile laser scanning System, please refer to the 'LiMobile M1 Mobile Scanning System User Guide'. Product user manuals are provided for reference only. Our company reserves the right to update the manual content at any time to reflect the latest product information and improvements. The hardware specifications of the LiMobile M1 device are based on the actual product and the contents of the packaging list.

2.1 Product Name and Composition

Product Name: LiMobile M1 Mobile Laser Scanning System

Product Components:

- (1) Global Navigation Satellite System (GNSS): Used to measure the spatial location of reference points for laser signal emissions.
- (2) Inertial Navigation System(INS): Used to measure the attitude parameters of the primary optical axis of the scanning device.
- (3) Laser Scanner: Used to measure the distance between reference points for laser signal emissions and ground laser footprints.
- (4) Camera System: Used to capture colored images of scanned objects.
- (5) Storage and Control System: Used for device control, receiving signals transmitted from the computer to the device, controlling device parameter adjustments, data collection, and more.

2.2 Key Specifications

Performance Indicators	Parameter
Laser Sensor	XT32
Laser Classification	Class 1 eye safety
Relative Accuracy	≤ 3 cm
Absolute Accuracy	10 cm@100 m
Weight	12.68 kg
Size	645 mm × 289 mm × 571 mm
Instrument Range	0.05 to 120 m
Scan Rate	640,000 pts/s @ Single return 1,280,000 pts/s @ Dual return
FOV (Vertical)	31°(-16° to +15°)
FOV (Horizontal)	360°

POS System	LiPos System	
Point Cloud Data Format	las, laz, liData	
Data Storage	512 GB SSD + 2 TB pluggable hard drive	
Port	HDMI, USB, LAN, ODO	
Battery Capacity	5875 mAh × 5	
Applicable Environment	Outdoor	
Max.Ground Speed	80 km/h	
Camera	Planar Camera/Ladybug5+ Panoramic Camera	
Pixels	8.9 MP/30 MP for Ladybug5+	
System Control and Data Display	Wireless Mode	The tablet is connected to the Wi-Fi of the device for operation control and data synchronization display.
	Wired Mode	The tablet is connected to the device via a data cable for data transmission and control.

3 System Description

3.1 Packing List

3.1.1 LiMobile M1 Packing List





20

1. LiMobile M1 integrated device	2. Standard ethernet cable	3. 2 TB hard drive
4. SATA to USB3.0 adapter	5. Ethernet to Type-C adapter	6. Screw
7. Ladybug5+ waterproof cover	8. Waterproof cover	9. Toolkit
10. Lens wiping paper	11. Customized ethernet cable	12. Battery
13. Battery compartment	14. Wi-Fi stick antenna	15. GNSS antenna bracket
16. Battery charger	17. GNSS antenna	18. Power cable
19. GNSS feeder cable	20. Push pull bracket	

3.1.2 LiMobile M1 Packing List (without the Ladybug5+ panoramic camera)





1. LiMobile M1 main body	2. 2 TB hot-swappable hard drive	3. SATA to USB 3.0 adapter
4. Ethernet to Type-C adapter	5. Standard ethernet cable	6. Waterproof cover
7. Toolkit	8. Lens wiping paper	9. Customized ethernet cable
10. Battery	11. Battery compartment	12. Wi-Fi stick antenna
13. GNSS antenna bracket	14. Battery charger	15. GNSS antenna
16. Power cable	17. GNSS feeder cable	18. Push pull bracket

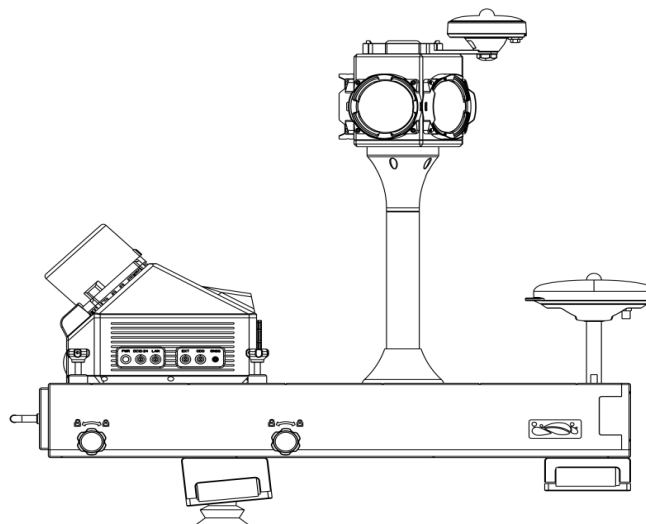

3.2 Laser Scanner

Model	XT32
Instrument Range	0.05 to 120 m
Frame Rate	5 Hz, 10 Hz, 20 Hz
FOV (Vertical)	31° (-16° to +15°)
FOV (Horizontal)	360°
Range Accuracy	±1 cm
Operating Temperature	-20°C ~ 65°C
Scan Rate	640,000 pts/s @ Single return 1,280,000 pts/s @ Dual return

3.3 Planar Camera

Pixel	8.9 MP
Frame Rate	13 FPS
Resolution	4096×2160
Sensor Type	CMOS
Sensor Size	1 "
Power Consumption	3.8 W

3.4 Panoramic Camera

Model	Ladybug5+
Pixel	30 MP (5 MP x 6 sensors)
Frame Rate	30 FPS (JPEG Compression)
Resolution	8192×4096
Sensor Type	CMOS
Sensor Size	2/3 "
Power Consumption	13 W maximum

3.5 Inertial Navigation System

GNSS System			GPS: L1C/A, L1C, L2C, L2P, L5 GLONASS: L1C/A, L2C, L2P, L3, L5 BEIDOU: B1, B2, B3 GALILEO: E1, E5a, E5b		
IMU Update Rate			Standard: 100 Hz (User selectable up to 300 Hz)		
Accelerometer	Bias In-run Stability	0.02 mg (1 σ)	Gyro	Bias In-run Stability	3 $^\circ$ /hr (1 σ)
	Bias Repeatability	1 mg (1 σ)		Bias Repeatability	65 $^\circ$ /hr (1 σ)
	VRW	0.02 m/s/ \sqrt hr		ARW	0.15 $^\circ$ / \sqrt hr
	Operating Range	\pm 16 g in all axes		Operating Range	+/- 490 $^\circ$ /s in all axes

3.6 Wi-Fi Information

Frequency Range	2.4 GHz
Security	WPA2-Personal
Gateway Address	http://172.16.0.1
Connections Allowed	1 device
Connection Range	5 m
WIFI SSID	LiMobile_XXXX
Default Password	greenvally

4 LiMobile M1 Data Collection Requirements

4.1 Weather Conditions

(1) When high image quality is required, the weather should be clear or cloudy. In cloudy conditions, there must be a visible blue sky, and the clouds must be white, not dark clouds. Air visibility of more than 6 kilometers.

(2) When image quality requirements are not high, and only point cloud accuracy is needed, the weather can be clear, partly cloudy, or overcast, with an air visibility of more than 1 kilometer.

4.2 Collection Time

When determining the data collection time for street-level road data, it is important to adhere to the following principles:

- (1) Daytime data collection should avoid periods of weak lighting;
- (2) Nighttime data collection should occur during well-lit periods;
- (3) When collecting data in city centers, it is advisable to avoid peak commuting hours to enhance collection efficiency.

In optimal weather conditions, the recommended data collection time is between 09:00 and 17:00. However, it is important to note that this time range may be flexibly adjusted based on actual circumstances, considering variations in seasons, time zones, or latitudes.

4.3 Collection Route

(1) During data collection, roads must be captured in their entirety, including turning lanes. There should be no missing sections in the collected data.

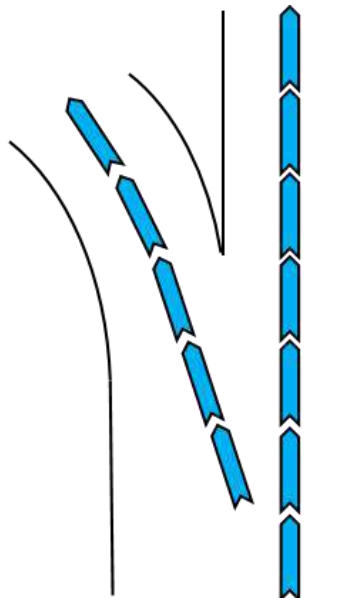

(2) When collecting data on one-way roads, try to drive along the centerline of the road as much as possible.

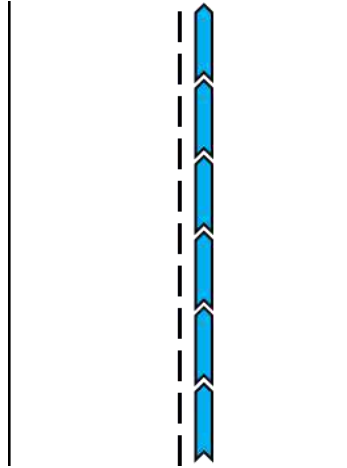

(3) Prioritize data collection along straight roads and try to avoid left or right turns or circular routes. Prefer straight roads to minimize lane changes and aim to maintain a linear data collection.

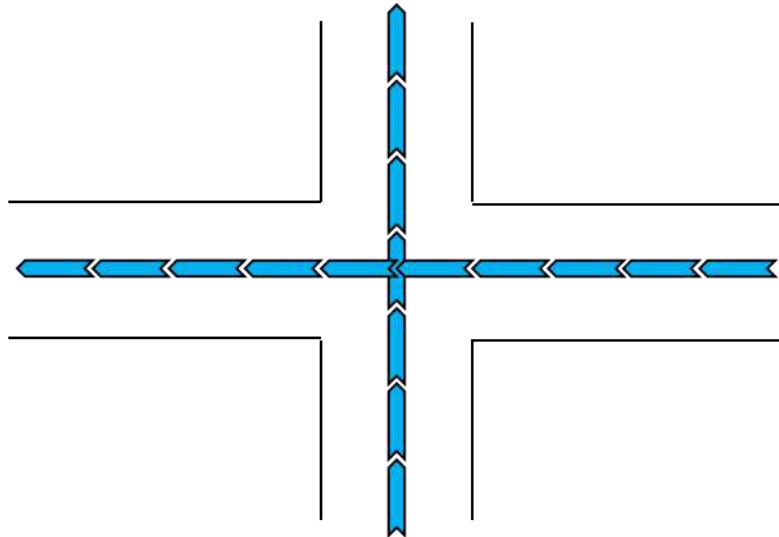

(4) When there are main and secondary roads, prioritize the collection of main roads. The secondary roads, including highways, elevated roads, and ring roads, must be collected. Main and secondary roads should be collected separately, without cross-collection between them. Connection roads between main and secondary roads do not need to be collected.

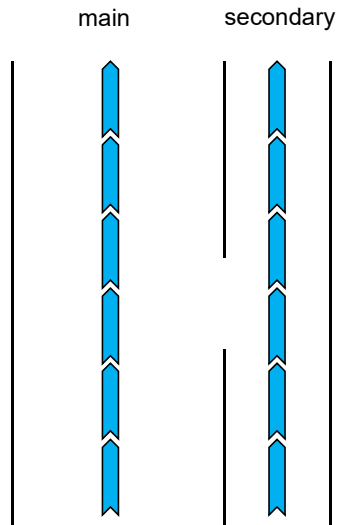

(5) Two-way roads must be collected in both directions. When collecting on a two-way road, try to drive along the centerline of one side. If the single lane has an even number, drive along the middle line on the right side.

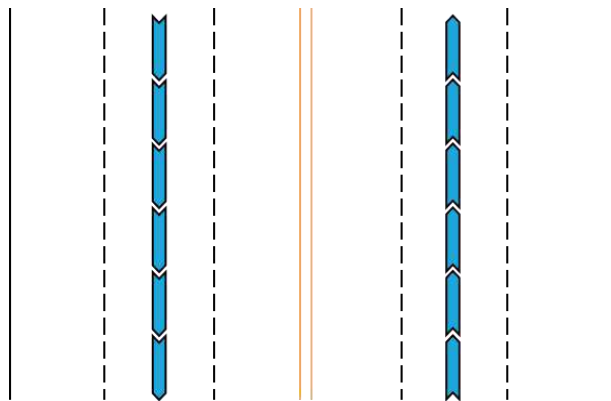

(6) When collecting data at roundabouts, it is essential to complete the roundabout enclosure. This means that the vehicle must travel around the roundabout on the innermost lane, capturing the actual shape of the roundabout.

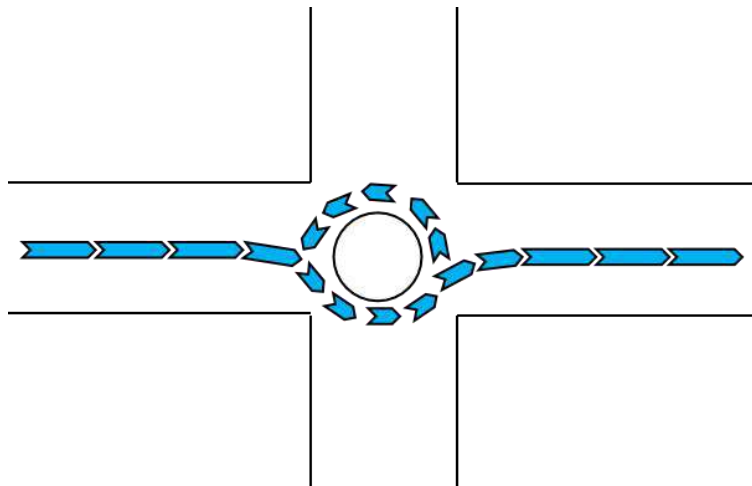

(7) Collecting data on overpasses can be complex. To ensure road connectivity, it is necessary to collect complete data for each ramp of the overpass. The collection process involves first

collecting data in a straight line along the mainline of the overpass and then separately collecting data for each ramp of the overpass.

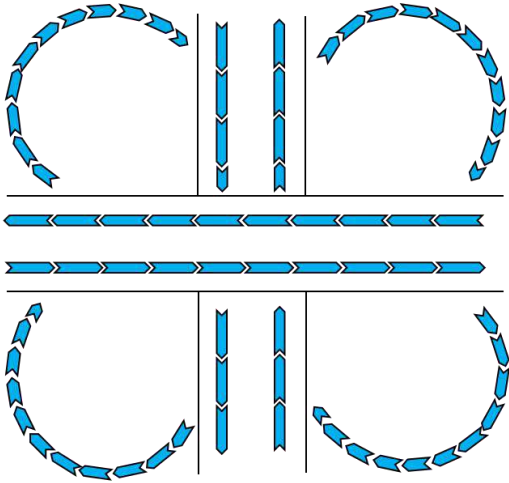

5 Preparation and Precautions For Data Collection

5.1 Pre-Project Preparation

Confirm if the weather conditions meet the data collection requirements (if high-quality images are required, try to avoid collecting data on cloudy days).
Check if there is sufficient power for the data collection task.
Check the accessories listed in the 'LiMobile M1 Packing List' to ensure they are complete.
Ensure the installation of the base stations before data collection.
Confirm that the deployed control points meet the required accuracy during data collection.
Refer to the street map for path planning and height restriction checks, and conduct on-site investigations if necessary.
Check the available memory space according to the 'LiMobile M1 Data Size Calculator' appendix.

5.2 Mounting the System Precautions

Ensure a stable connection between the luggage rack crossbars and the push pull brackets; check if screws are tightened.
Check the stable connection between the luggage rack crossbars and the vehicle, and whether the latches or screws are tightened.
After pulling out the push pull bracket, check if the push pull bracket knobs are tightened.
Check if the screws between the LiMobile M1 main body and the push pull bracket are tightened.
Check if ladybug5+ is securely connected to the push pull bracket.
Verify if ladybug5+ is securely connected to the antenna and support poles.
Check the orientation of ladybug5+ installation (Lens 0 should face the direction of the LiDAR).
Check if the cables are properly connected.
Check if the battery compartment is properly opened.
After powering on the equipment, check if the device indicator lights stay on continuously.

5.3 System Operations Precautions

After powering on LiMobile M1, please ensure that the tablet computer is initially connected to the device's Wi-Fi.
After turning on the device, please ensure that the device is properly connected according to the prompts on the web interface.
Ensure that the base station is set up before LiMobile M1 data collection.
Ensure that at least 15 satellites are available for inertial navigation initialization.
During the INS alignment process, it is necessary to remain stationary for 5 minutes first, followed by two accelerations and decelerations, U-turn, and then two more accelerations and decelerations. This process is to ensure data quality.

6 LiMobile M1 Installation

LiMobile M1 supports vehicle scanning for data collection.

6.1 Push Pull Bracket Installation

Secure the push pull bracket firmly to the luggage rack crossbar using the fixing screws located underneath the push pull bracket.

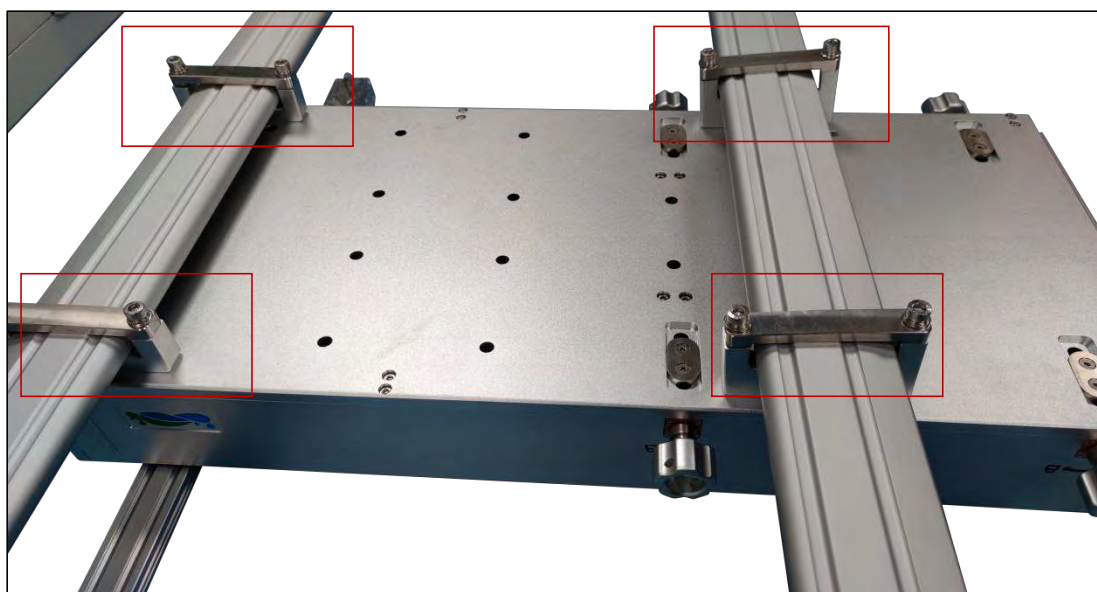

Notes: After tightening, please cross-check the locking degree and confirm it in time.

6.2 Luggage Rack Crossbar Installation

Place the luggage rack crossbar and the push pull bracket together on the roof, and use a hexagonal screwdriver to lock the roof rack into place.

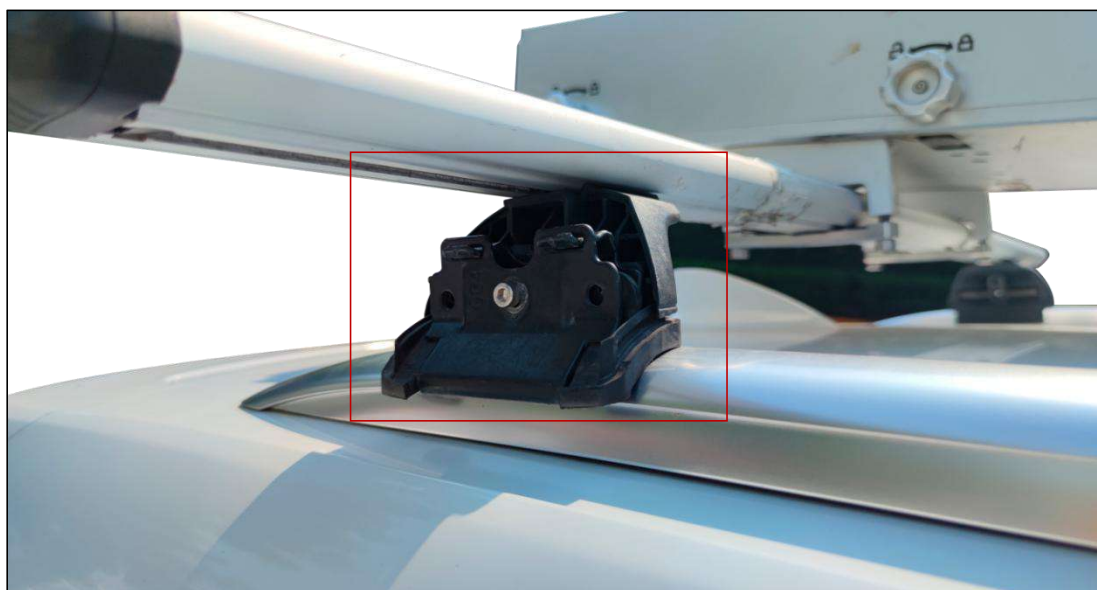

Notes: Shake the luggage rack crossbar vigorously to confirm its firmness.

6.3 Pull Out and Fix the Push Pull Bracket

Loosen the bracket fixing bolts in the unlocking direction, pull out the bracket to a suitable position, and then lock the fixing bolts in the locking direction.

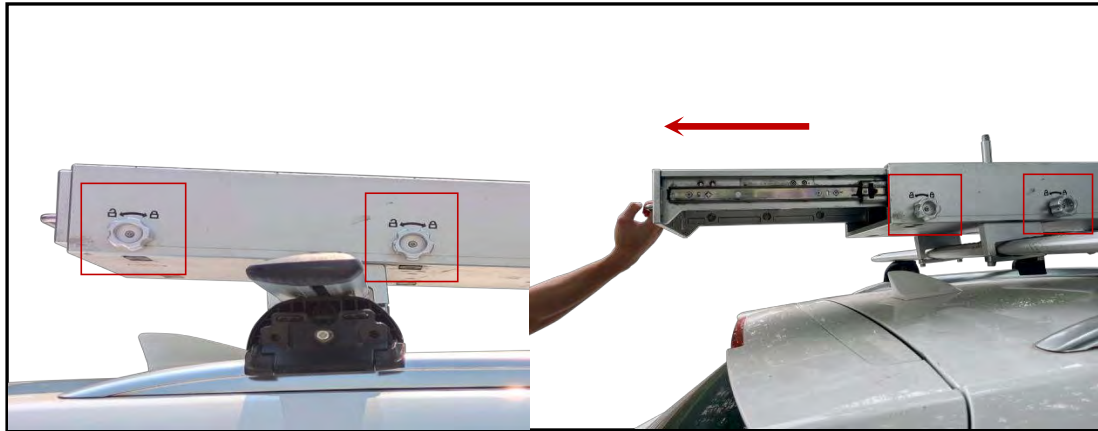

Notes: Shake the bracket after locking to ensure that it will not stretch. If the user does not have the Ladybug5+ panoramic camera, please skip to section 6.5.

6.4 Integrated Equipment Installation

Place the integrated device on the push pull bracket and secure it using screws. Connect the two connecting cables of Ladybug5+ to the USB 3.0 port and the LEMO port in the CAM respectively.

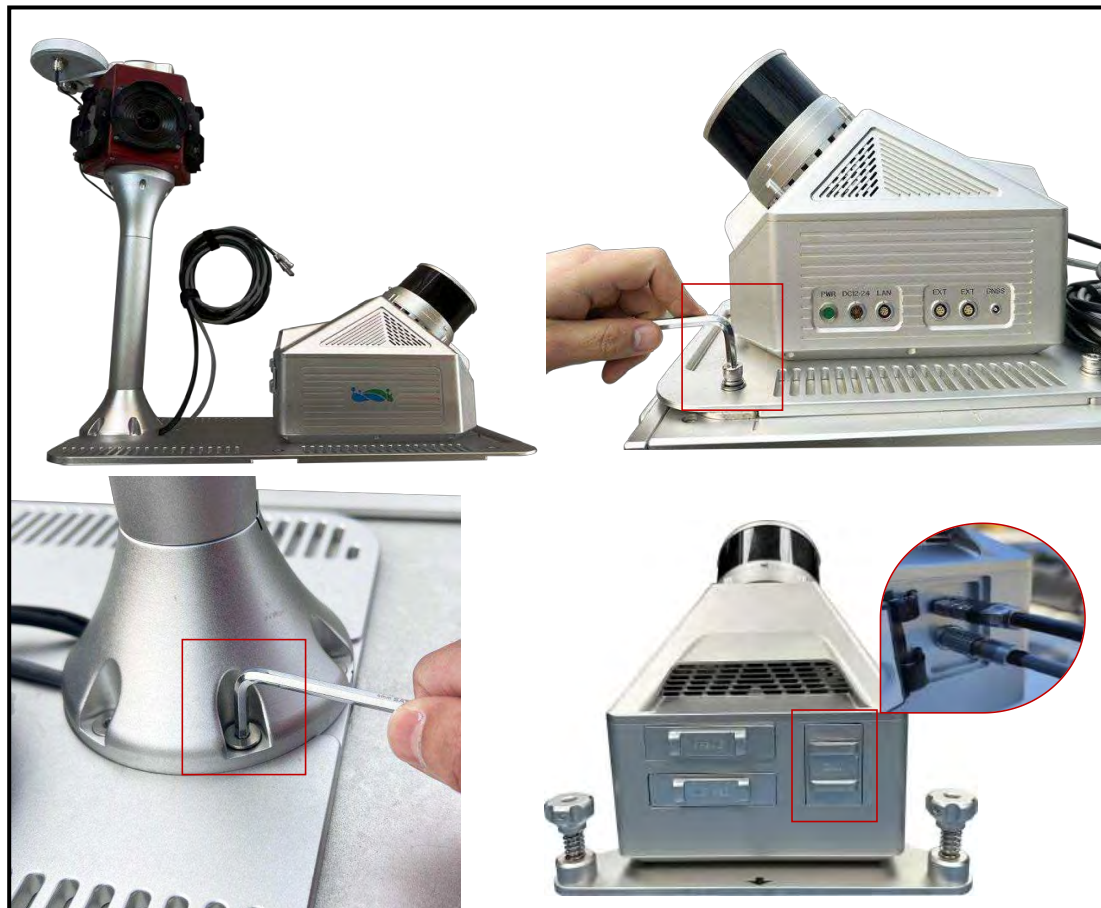

*6.5 LiMobile M1 Main Body and GNSS Antenna Installation

(without the Ladybug5+ panoramic camera)

Place the main body of the device on the base of the push pull bracket, align the screw holes, and manually tighten the 4 fast-assembly bolts to fix it. Mount the GNSS antenna bracket onto the pull pull bracket and manually tighten the GNSS antenna.

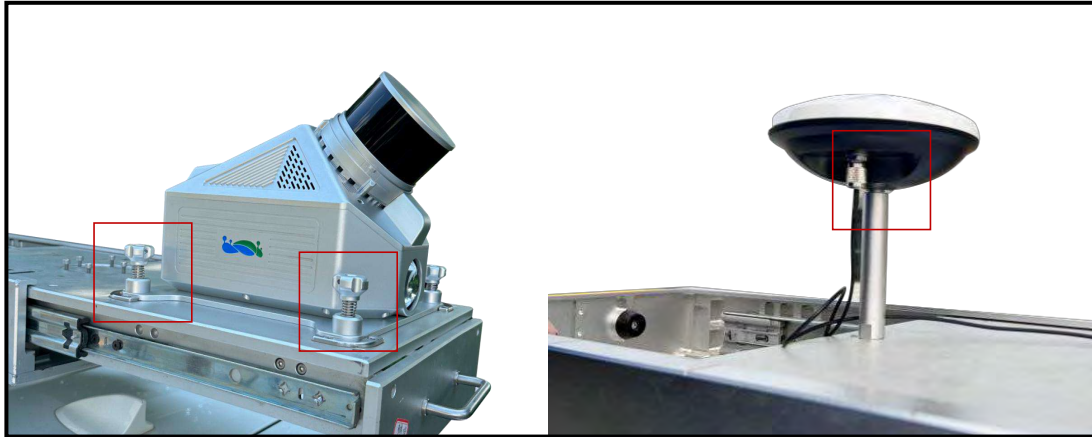

6.6 GNSS Feeder Cable Connection

Use the GNSS feeder cable to connect the GNSS antenna to the GNSS port of the LiMobile M1 main body.

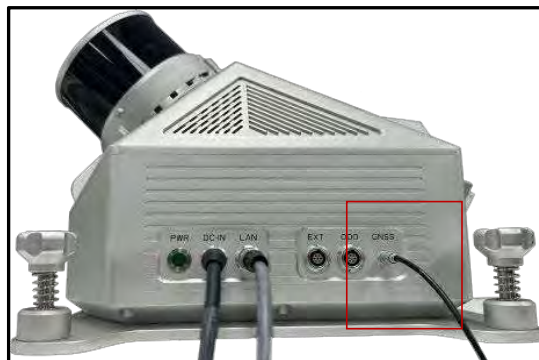

6.7 Wi-Fi Stick Antenna and Battery Installation

Install the Wi-Fi antennas to the ANT1 and ANT2 ports of the battery compartment by hand-tightening the bolts and insert the batteries.



6.8 Power Cable and Ethernet Cable Connection

Connect the power cable by plugging it into the ReMo heads, and then connect the DC-OUT interface of the battery compartment to the DC interface of LiMobile M1 main body. Use an Ethernet cable to connect the LAN interface of the battery compartment to the LAN interface of the LiMobile M1 main body.

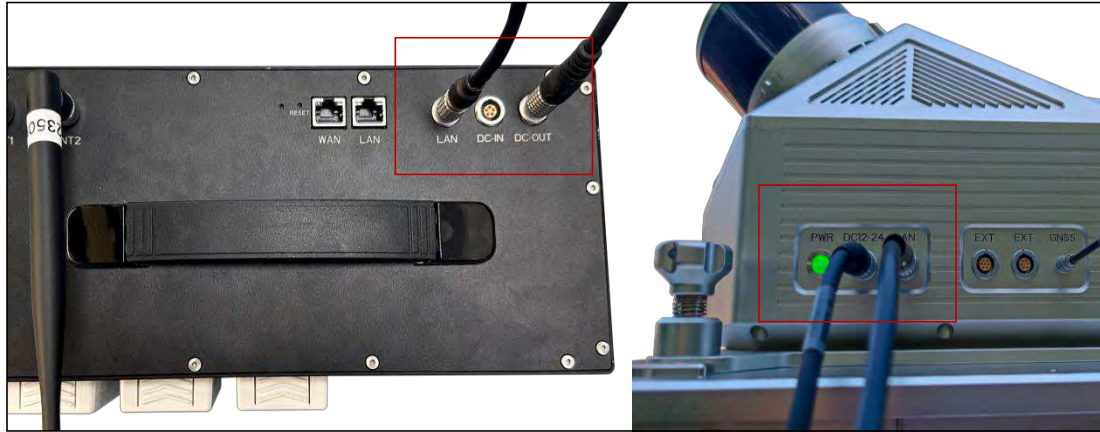

6.9 LiMobile M1 Installation Completed

The overall effect figures are shown below.



7 LiMobile M1 Operation Procedure

Please strictly follow this guide to ensure that all functions of the device are normal.

7.1 Base Station Setup

7.1.1 Base Station Installation

Arrange LiBase base stations in open areas or known control points, without vibration, away from signal interference sources. For projects with higher precision requirements, it is necessary to set up a tripod according to the surveying and mapping specifications, and set up the base station on the tripod.



LiBase GNSS Receiver

7.1.2 Device Connection

Long press the power button of the base station to turn it on, and then open the LiSurvey software on the data collector/Android mobile phone. On the 'Device' page, click 'Connection' to establish a connection through Bluetooth.

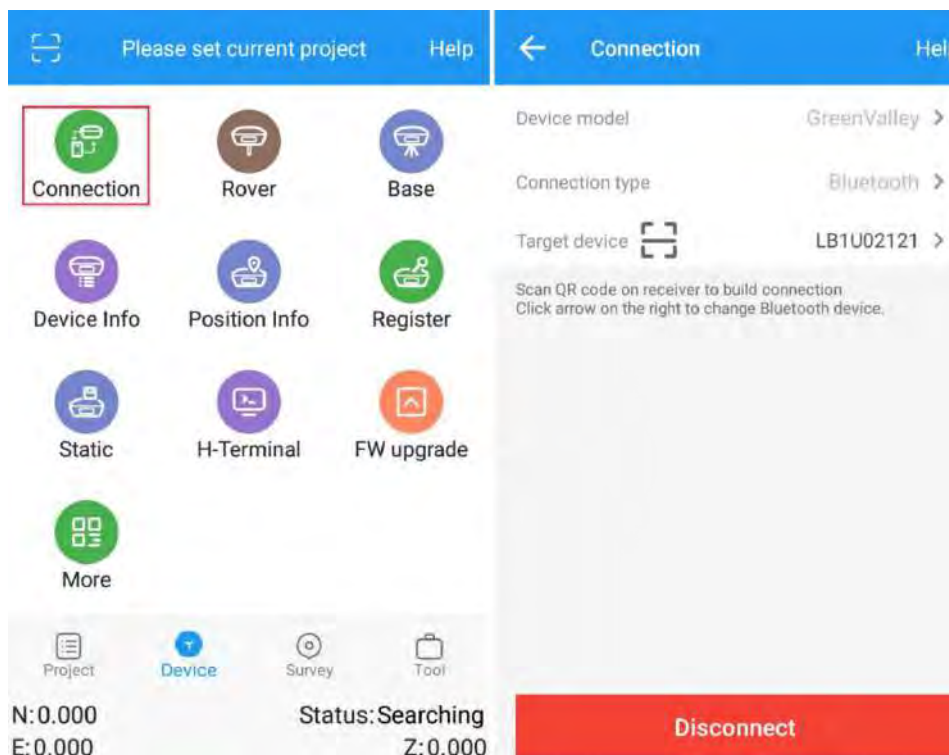

Device Connection

7.1.3 Coordinate System Setting

On the 'Project' page, click 'Project' to create a custom coordinate system. As shown in the figure, it is a WGS84 ellipsoid, UTM projection, and the central meridian is 117°, which is the 50-degree zone.

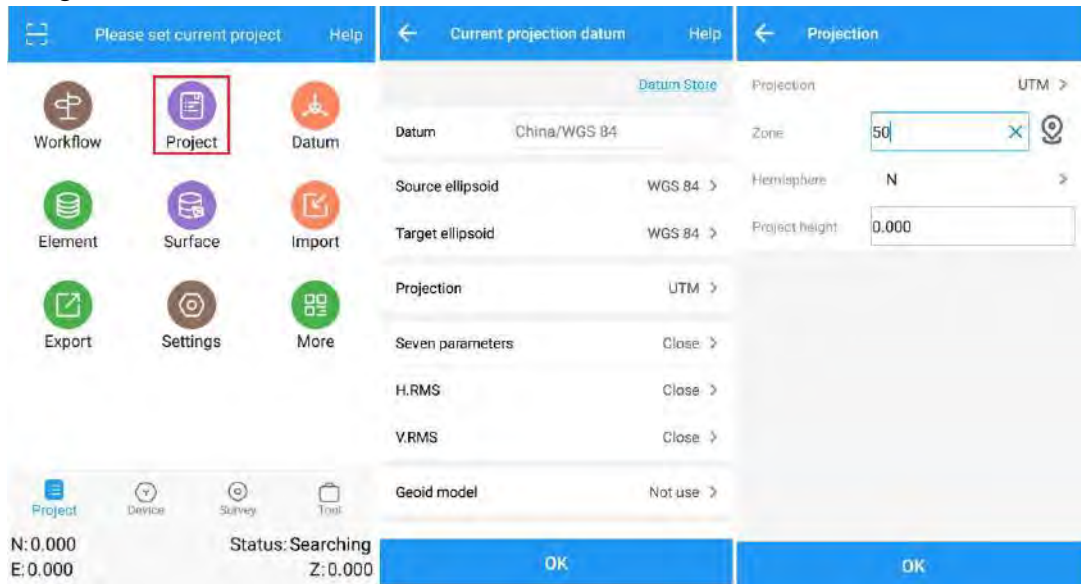

Coordinate System Setting

7.1.4 Static Recording

On the 'Device' page, open 'Static collection' and customize the file name, site, and storage path. Set the sampling frequency and antenna height, and after confirming that the settings are correct, click 'Start Recording' to record static data.

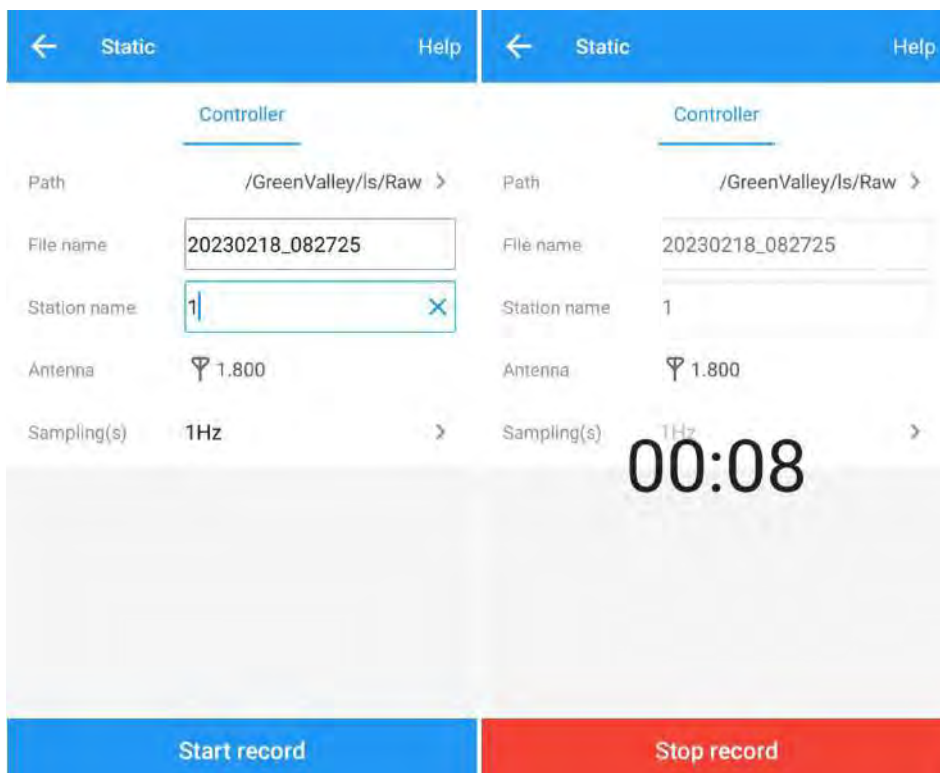

Static Recording

7.2 Device Power On

Press and release the round button in the middle of the battery. Then press and hold it again for 2 seconds until the green indicator on the button illuminates. Now both the battery and the main body start to work, the power supply indicator will be on.

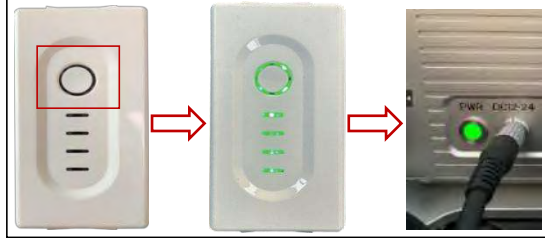

Notes: The battery compartment can accommodate up to 5 batteries to meet the work requirements. In typical data collection scenarios, LiMobile M1 can sustain continuous data collection for about 3 hours. When the battery level is less than two bars, please replace the battery promptly. When replacing the battery, users should ensure that one battery is successfully replaced before proceeding to replace the next one. In 1 minute after powering on the LiMobile M1 system, Wi-Fi hotspot signal should be available. You can connect a mobile terminal to the device through Wi-Fi or cable.

7.3 Device Connection

7.3.1 Connecting To the LiMobile User Interface via Wi-Fi

Wi-Fi Name: LiMobile_XXXX

Wi-Fi password: greenvally

The user needs to modify the network adapter connection settings according to the image below firstly. After successfully connecting Wi-Fi, run Google Chrome and visit <http://172.16.0.1> to load the LiMobile M1 user interface.

Notes: XXXX represents the last four digits of the LiMobile M1's SN.

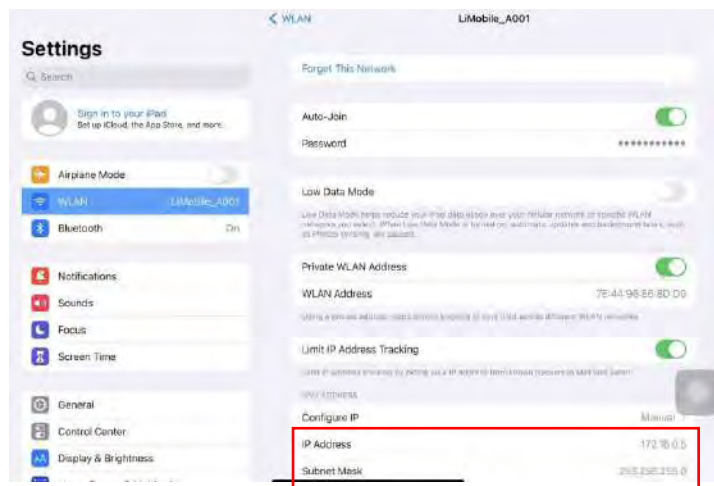

7.3.2 Connecting To the LiMobile User Interface via Ethernet Cable

Use an ethernet cable to connect the network port of the battery compartment and the network port of the mobile terminal, then modify the network adapter connection settings. After that, run Google Chrome and visit <http://172.16.0.1>, the user interface will be successfully loaded.

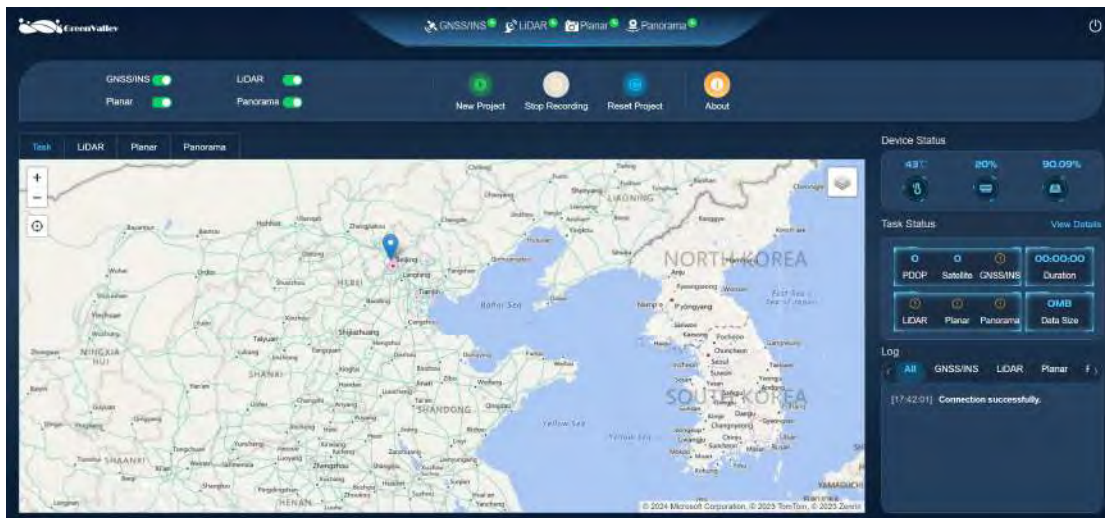

7.4 Data Collection

7.4.1 Confirm the Sensor Status

Wait for the indicator lights of each sensor in the diagram to turn green, indicating successful connection for each sensor.

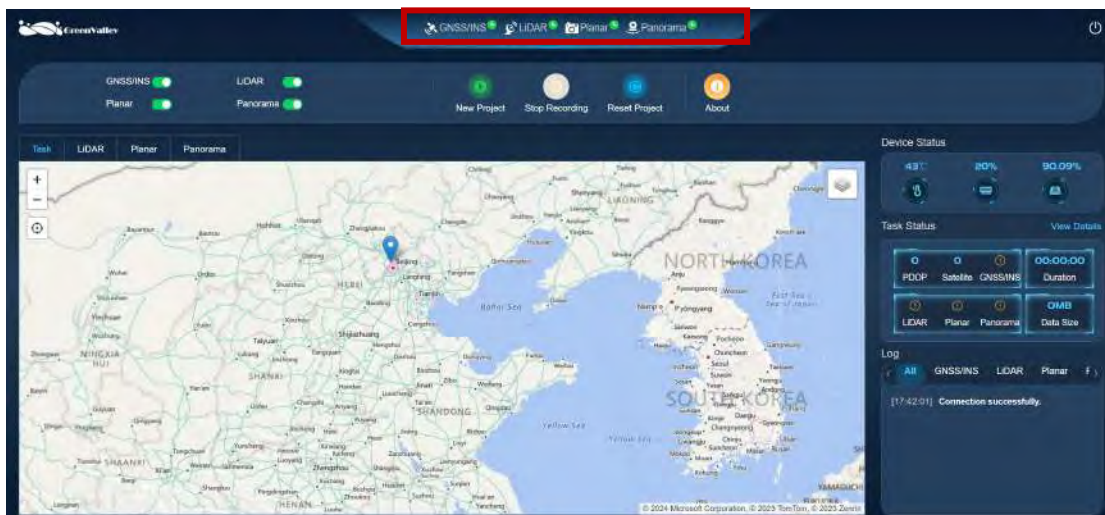

Tips: If the connection is unsuccessful and the user interface cannot be opened, please return to the Wi-Fi connection page to confirm whether it is connected.

7.4.2 New Project

Click the *New Project* button.

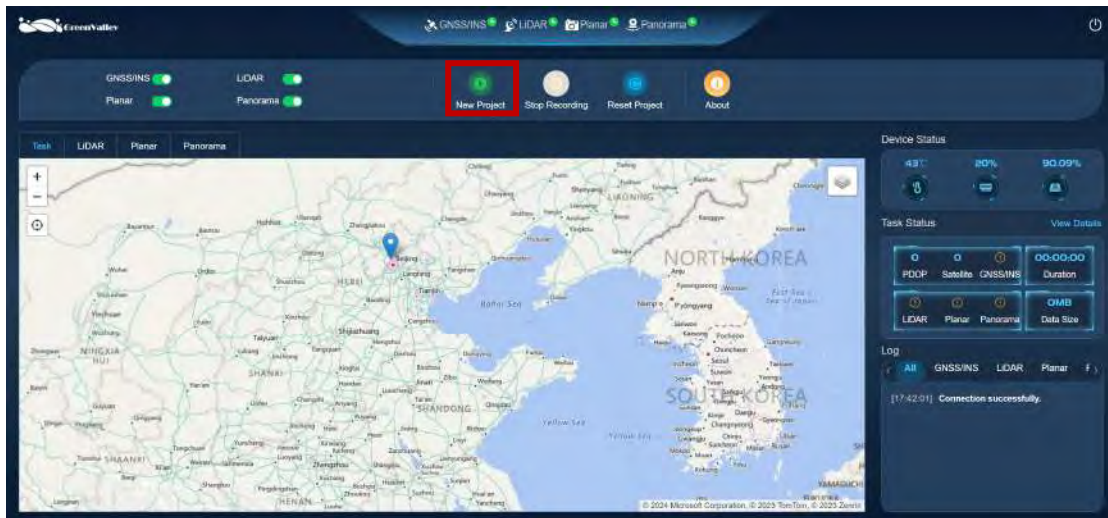

7.4.3 Device Initialization

Click the *Initialization* button, and the *Device Initialization* interface will pop up

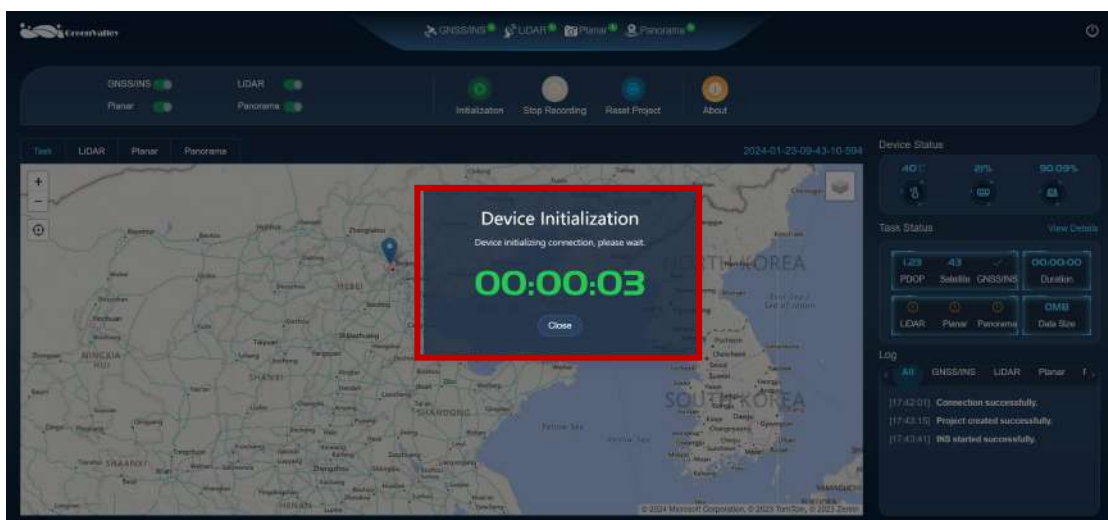
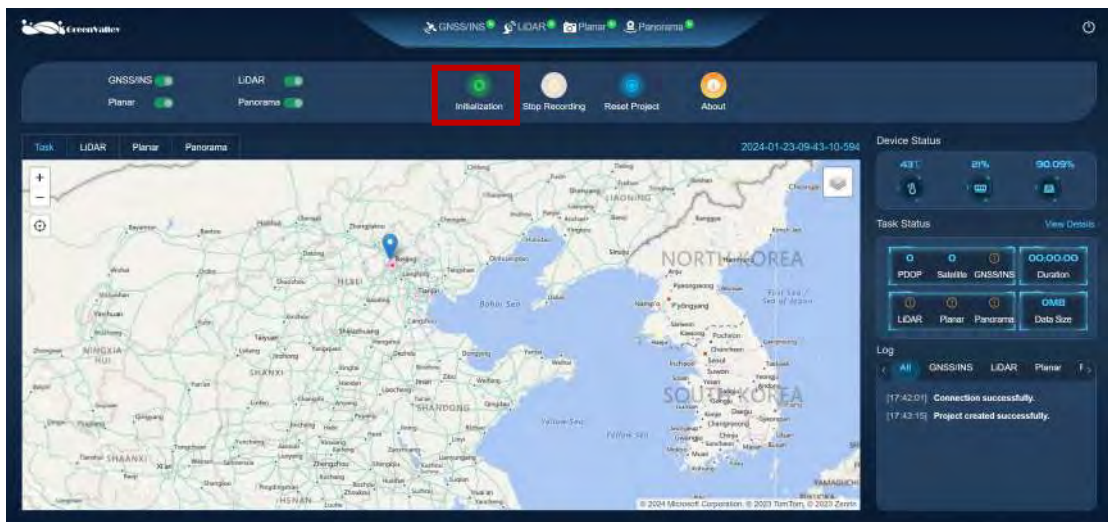

7.4.4 INS Alignment

After successful device initialization, the *INS Alignment* interface will pop up. INS alignment operation includes static alignment operation and dynamic alignment operation. Static alignment operation is to turn on the device in an open area to search for satellites, and the static time is 5 minutes. Dynamic alignment operation means that the users can start the vehicle to complete at least two straight-line acceleration and deceleration driving and several heading changes(left/right turns, U-turns) in an open area. When the IMU training is completed, click **OK** button to end the IMU training.

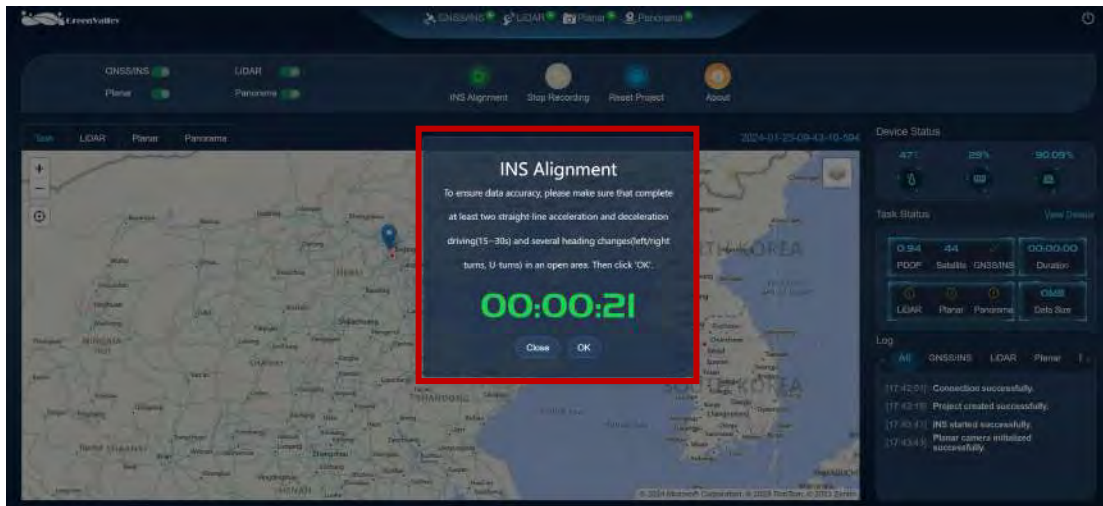

Tips: The standard steps of dynamic alignment are as follows. First, accelerate forward to 40km/h and slow down to 10km/h, then U-turn. Next, accelerate forward to 40km/h and slow down to 10km/h, then U-turn again. Finally, repeat the above-mentioned acceleration, deceleration and U-turn movement operation. In order to ensure the quality of collected data, it usually takes 5 minutes for static calibration and 3 minutes for dynamic calibration.

7.4.5 Start Data Recording

Click the *Start Recording* button for data collection.

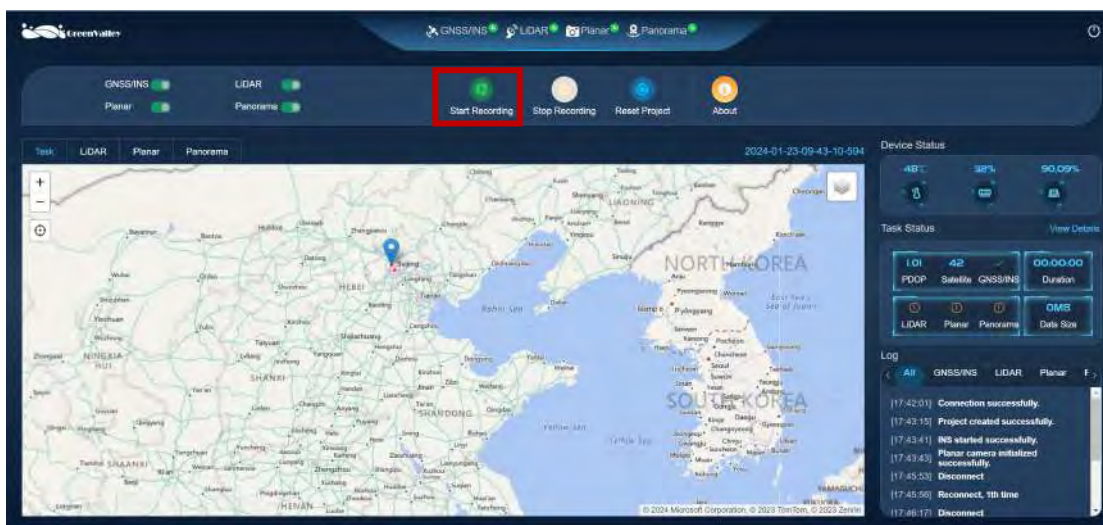

7.4.6 Data Collection

As shown in the following image, users can view the collection route and real-time data captured by LiDAR, planar camera, and panoramic camera during the data collection process.

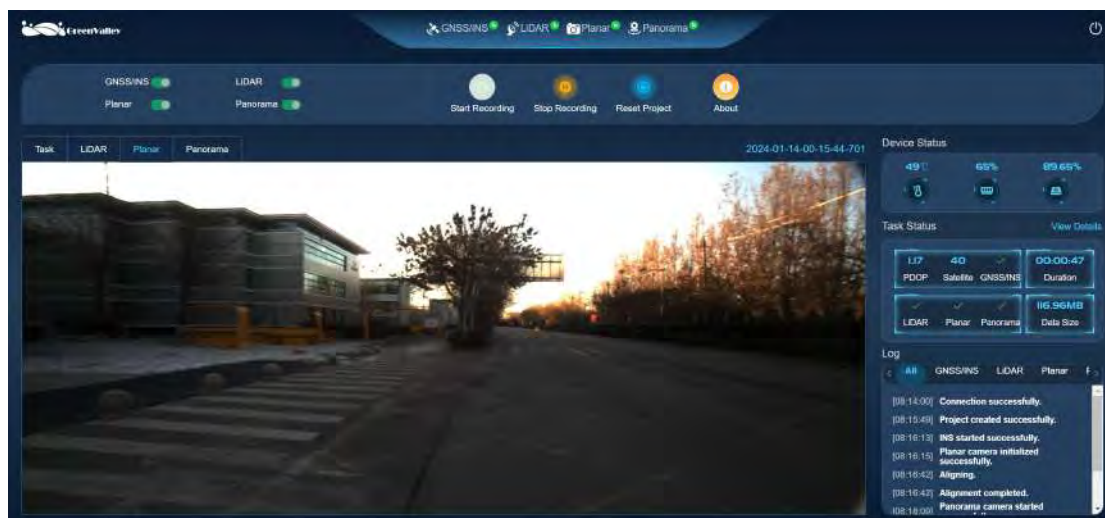
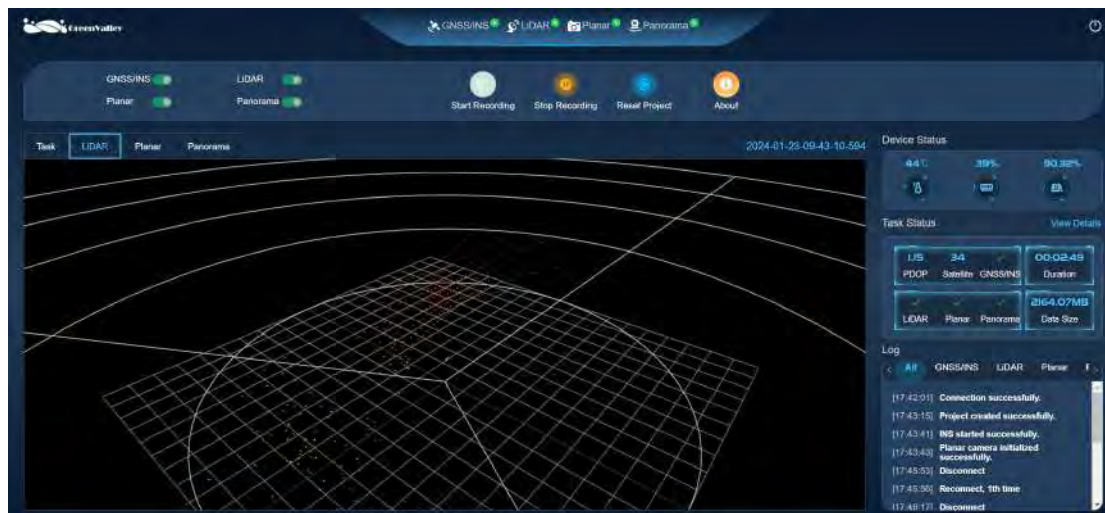
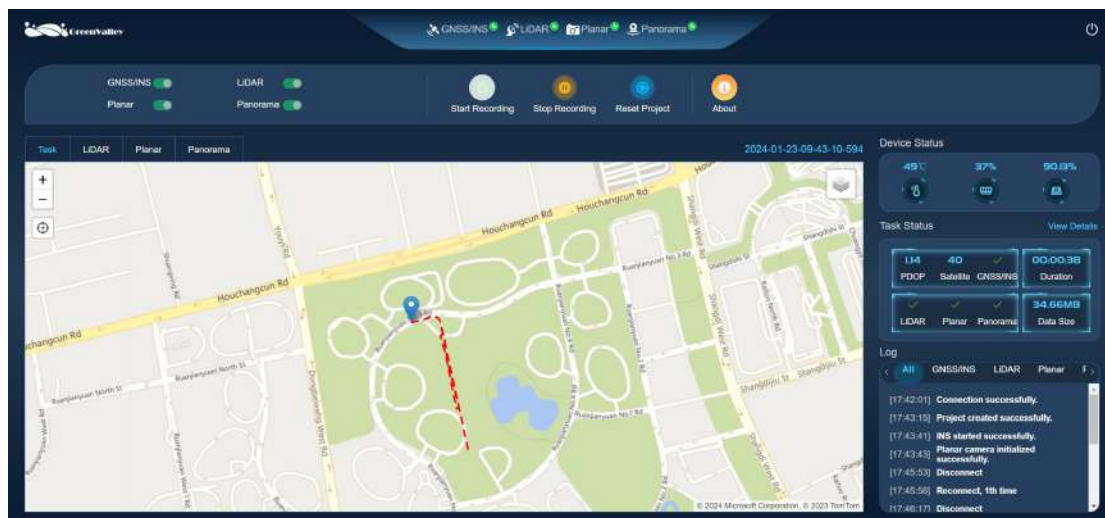



Users can also monitor the device status and task status in real-time on the right side of the interface, and click **View Details** button to obtain more information. Additionally, sensors are categorized in the logs, allowing real-time monitoring of whether the device is collecting data normally. In case of abnormalities, both the status and the logs provide alerts.

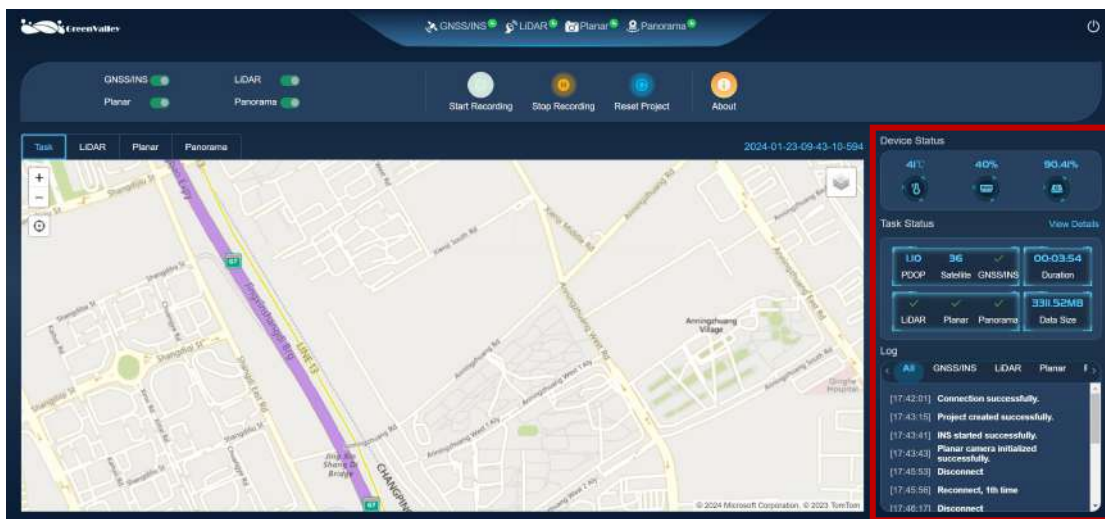

Tips: The user acquisition interface supports offline map functionality. Users can download offline maps in the GreenValley Map Tools program and save the data to the LiMobileSystem\map directory on the removable 2TB hard drive.

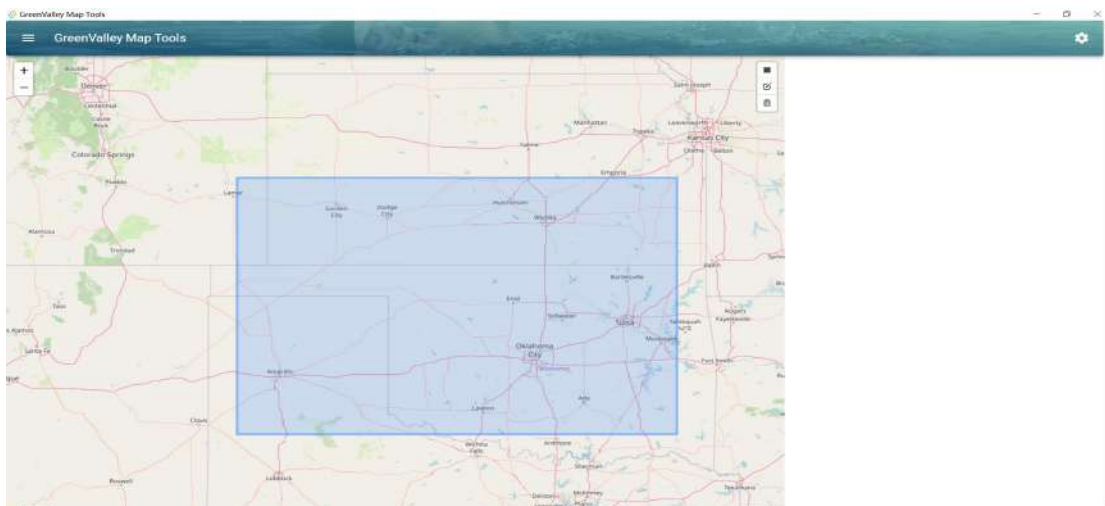
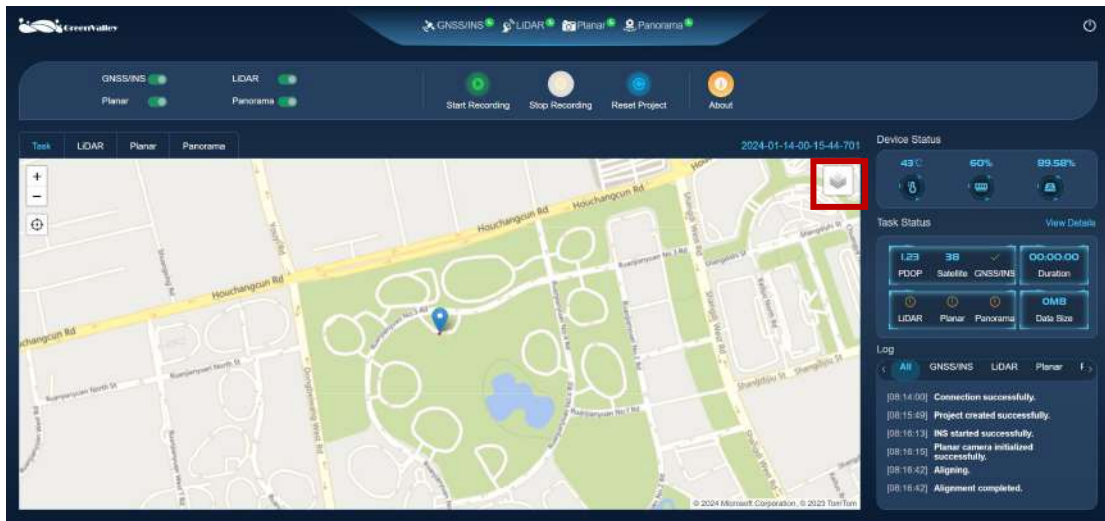

7.4.7 Stop Data Recording

Click the **Stop Recording** button and the **INS Alignment** interface prompt will pop up.

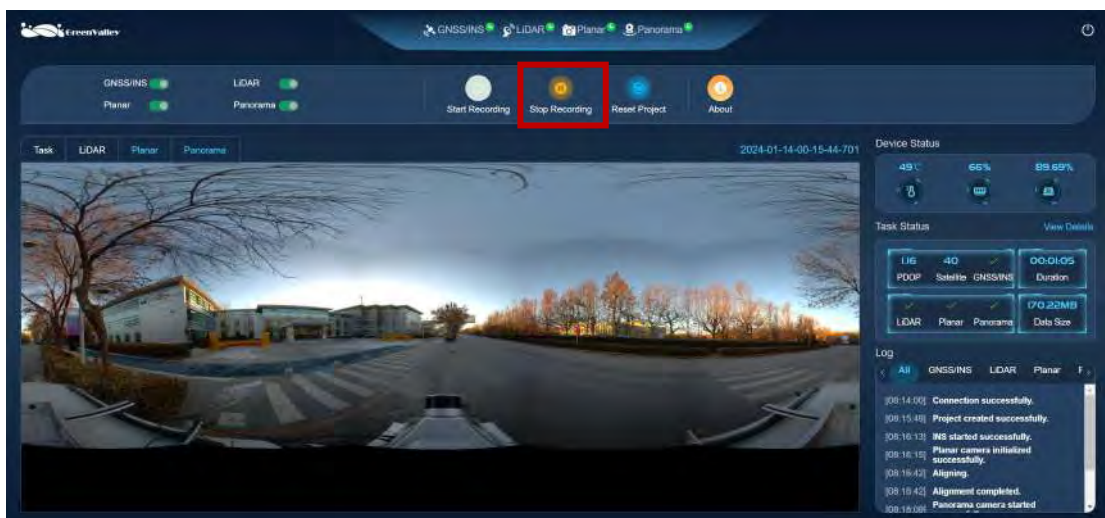

7.4.8 INS Alignment

This step also includes two parts: static alignment and dynamic alignment. After the collection is completed the dynamic alignment is started first. When the IMU training is completed, perform static alignment. After the static time of the IMU reaches 5 minutes, click **OK** to end the INS alignment.

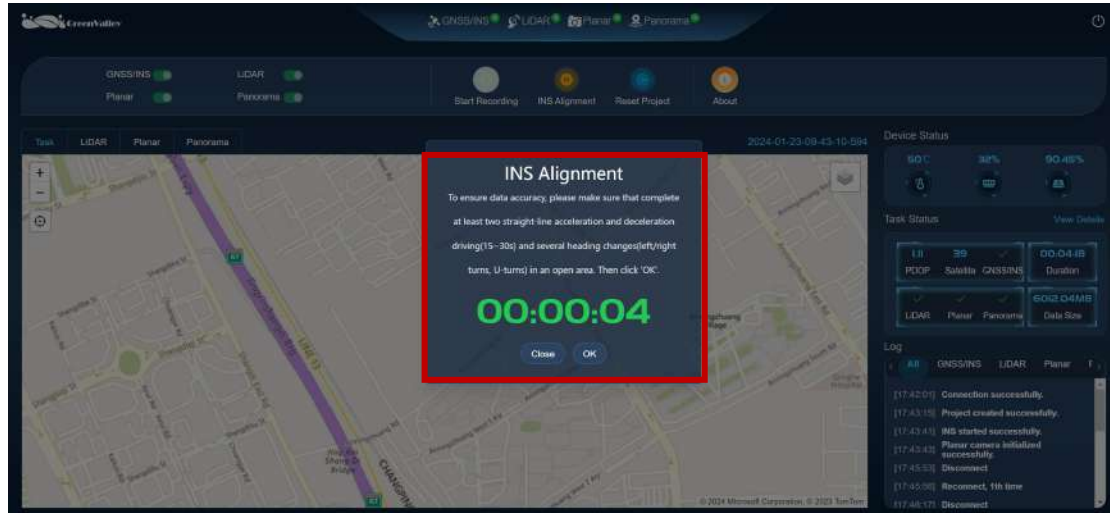

7.4.9 Close the Project

Click the **Close Project** button to stop the data collection, the display of main interface will restore to the default. At this time, if user need to acquire data again, just repeat the above steps. And user can click the **Reset Project** button to restore the interface to the initial data collection state.





Notes: The interface also features a *About* button for collecting page version updates.

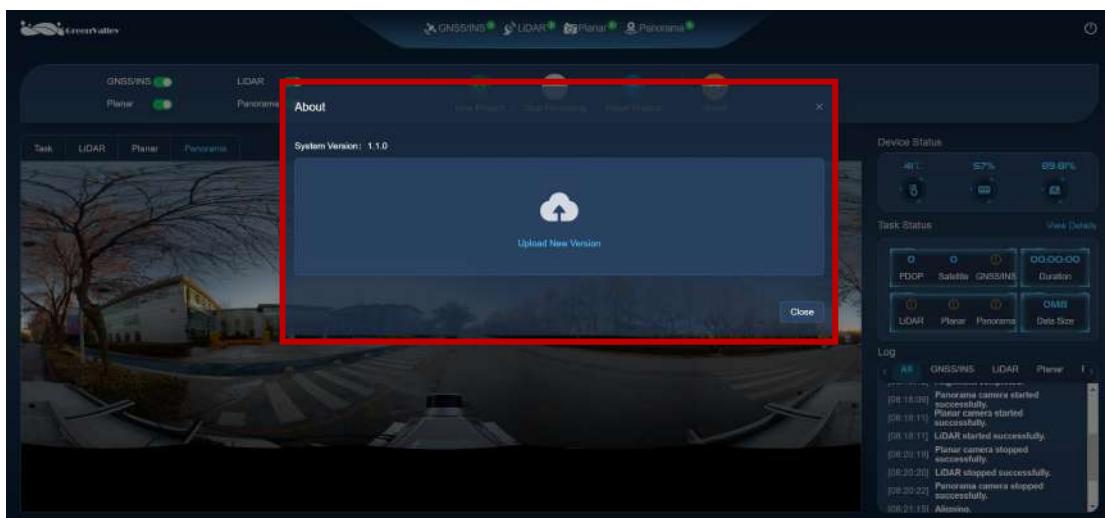
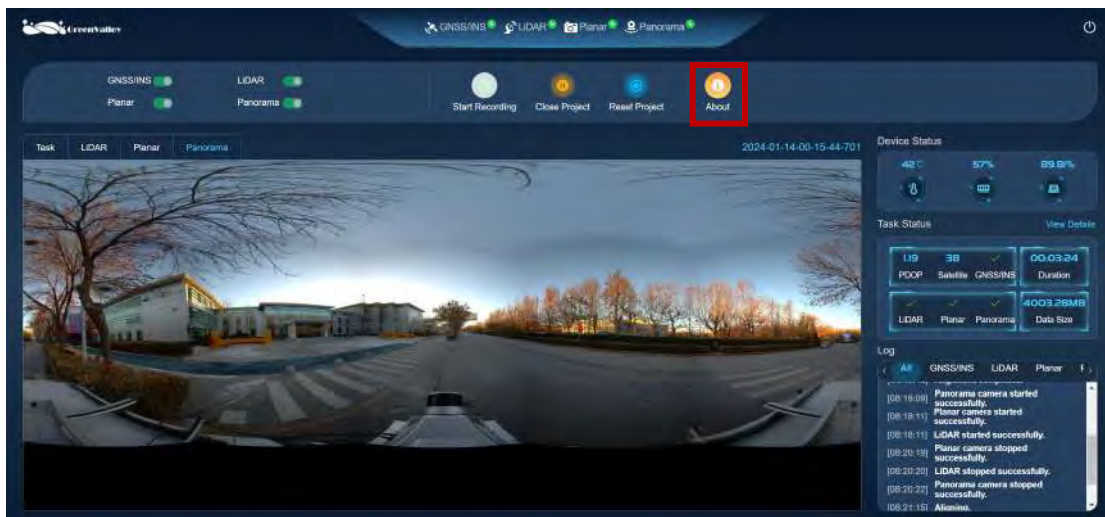

7.5 Device Power Off

After the data collection is completed, click the **shutdown** button in the upper right corner to shut down the device. Then short press the round button in the middle of the battery and release it and keep pressing the button for 2 seconds again. When the green indicator light on the button turns off, the power supply indicator on the main body of the device also goes out, indicating that the device is powered off.

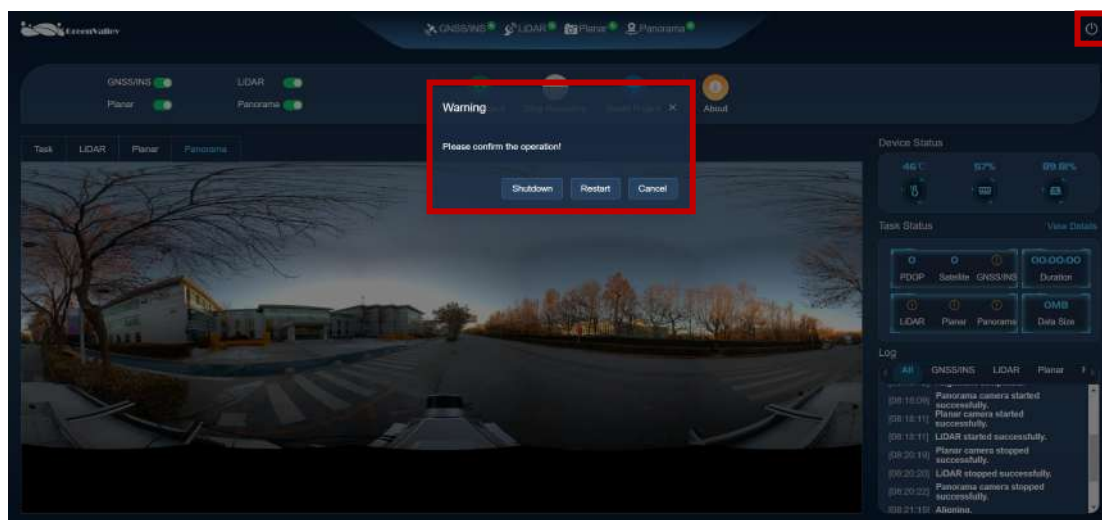

7.6 Battery Charging

When using the battery charger to charge, first, connect the charger and the batteries according to the diagram below. Do not need to worry about the port direction. Then turn on the charger switches. The red indicator light indicates that it is charging, and when the light turns green, it means the charging is complete.



8 Data Processing Procedure

The LiMobile M1 data processing primarily relies on LiGeoreference software and LiDAR360 MLS software. This includes data copy, data processing (point cloud filtering, panoramic image parsing, POS processing, point cloud processing), point cloud quality inspection and improvement, point cloud and panoramic image fusion quality inspection, and point cloud colorization. The detailed processing workflow as shown below.

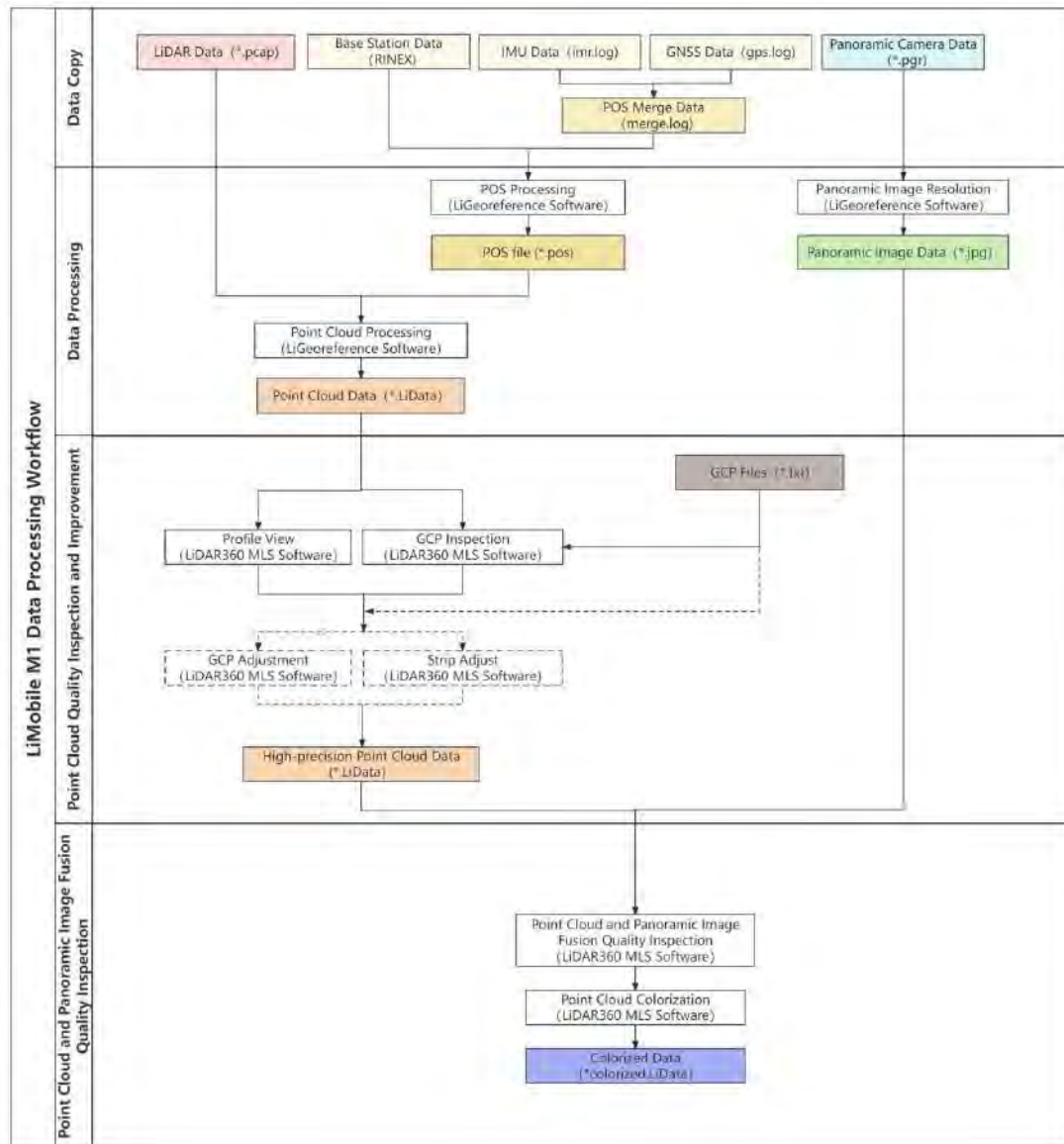

8.1 Data Copy

8.1.1 Data Copy Method

All collected data of the LiMobile M1 mobile laser scanning system will be stored in the project folder with the name displayed on the user interface.

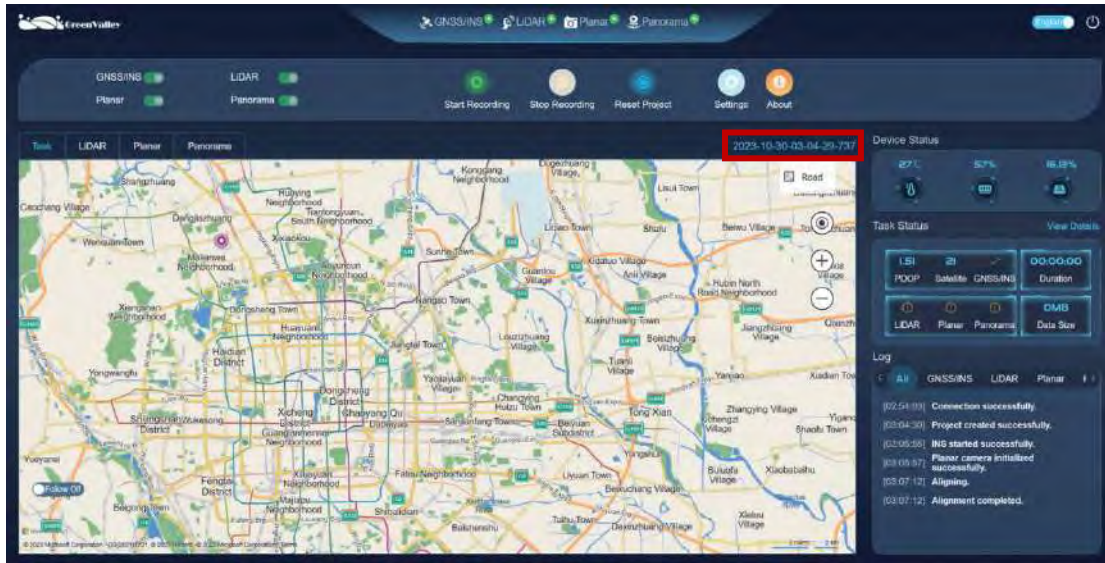

The data structure is illustrated below. The project folder includes the Calibrate folder, Cam folder, INSTraj folder, LaserRaw folder and project.live file etc. INSTraj-->IMU folder is used to store data collected by the global navigation satellite system including gps.log file, imu.log file, and merge.log file. LaserRaw folder is used to store the raw point cloud captured by the laser scanner. Cam folder in the Project folder is used to store the raw imagery captured by the cameras.

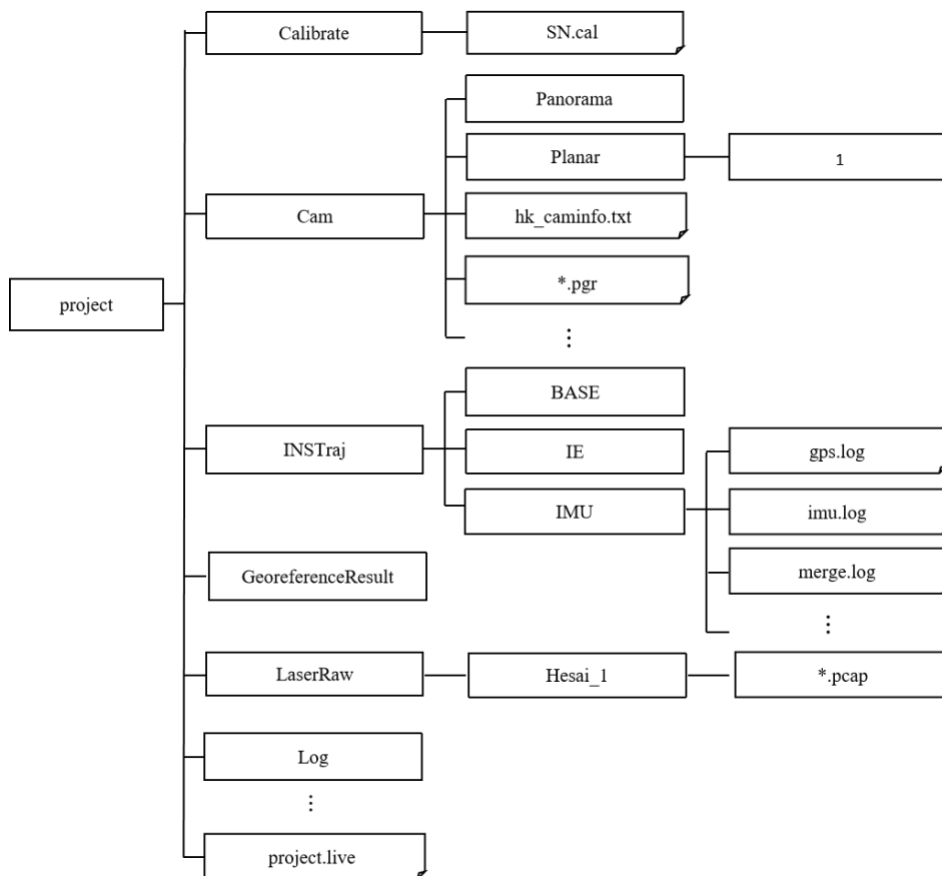

The LiMobile M1 is equipped with a 2 TB hard drive, which can be directly removed at the 2.5 SSD port. The data can then be copied to the computer for data processing using an adapter.



8.1.2 Data Integrity Check

Before data processing, users need to perform a check for data integrity. Users should mainly check the integrity of INS, laser, and image data, which can be found in the respective folders.

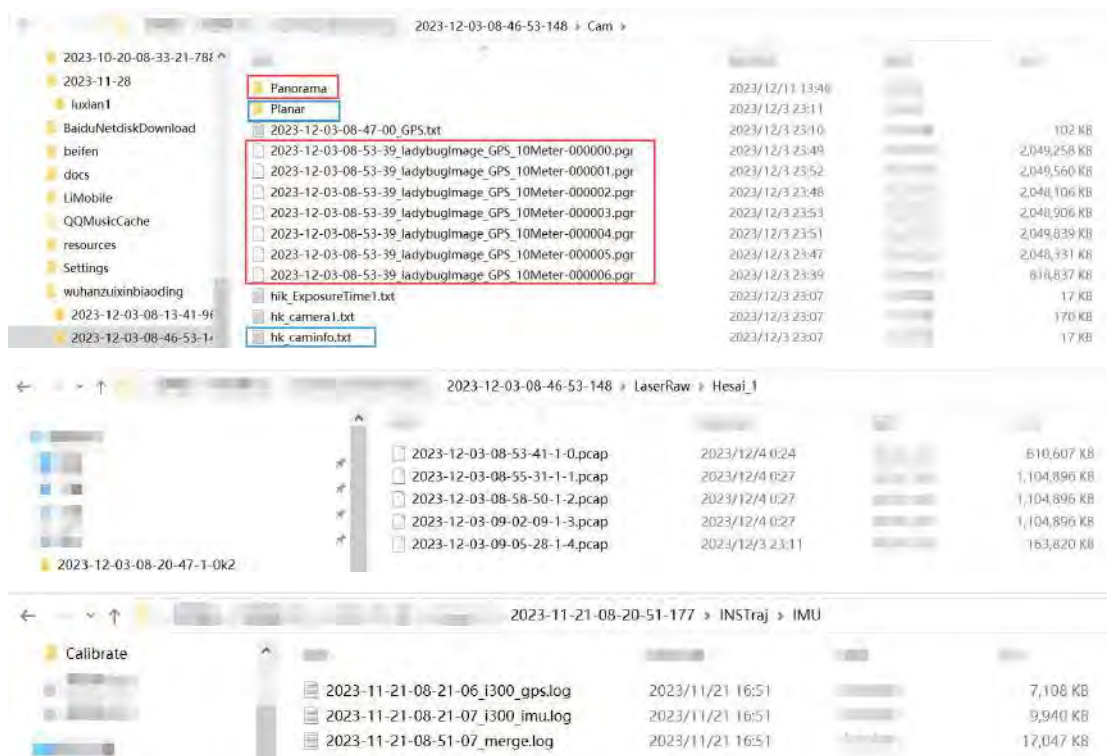

8.2 Data Processing

8.2.1 Open Project

Open the LiGeoreference software, select **Open**, click on **Browse** button, choose the *.live file in the project directory, and click the **Open** button.

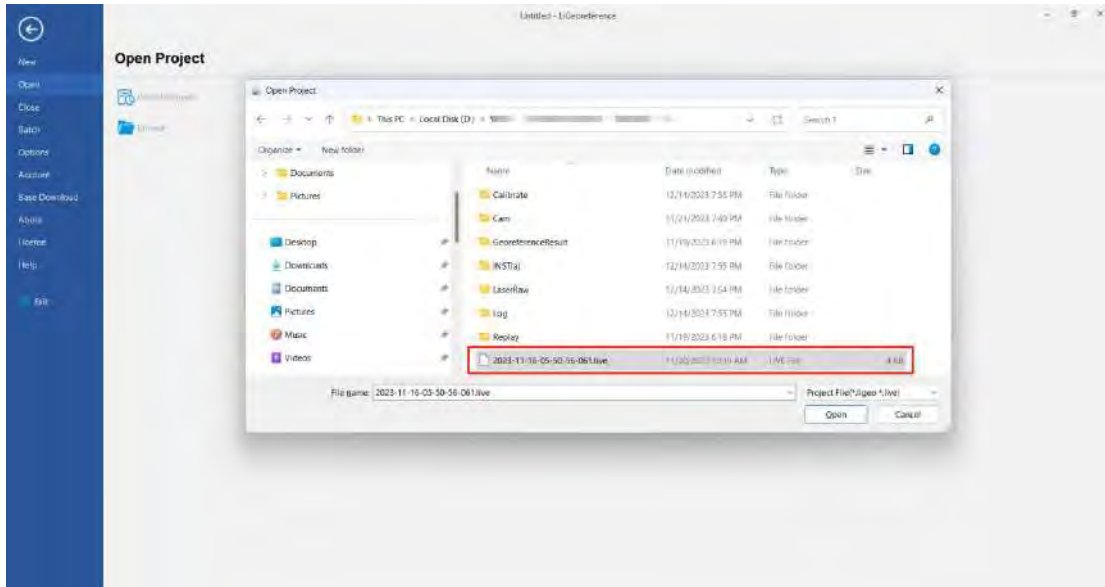

8.2.2 Project Settings

Click the **Settings** button in the upper left corner to configure the project, which include point cloud filtering, panorama image parsing, adding mobile station and base station data, and coordinate system configuration.

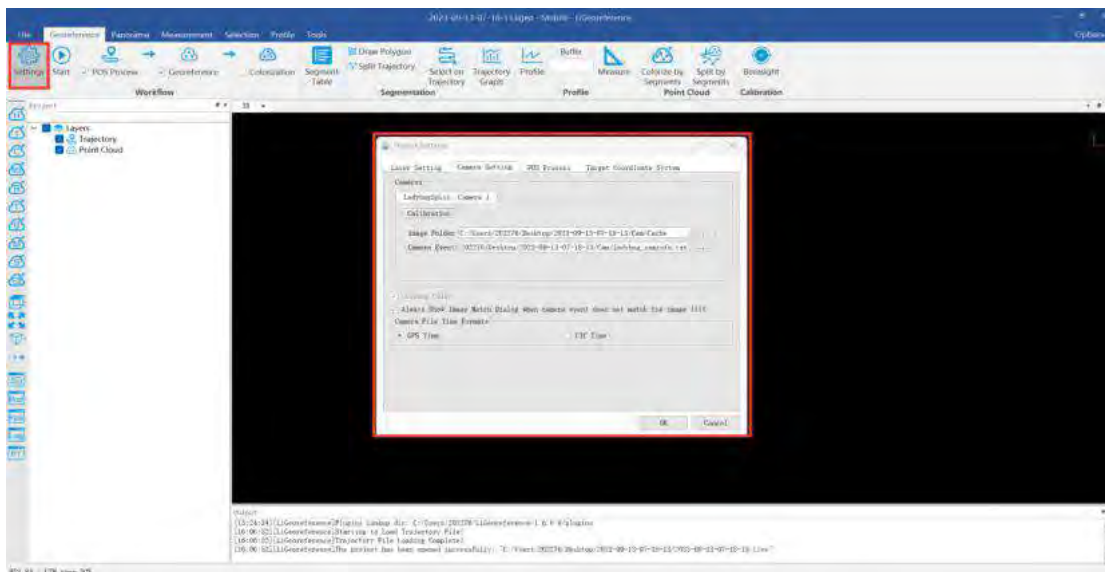

(1) Laser Setting

User can click **Filter** button to determine whether they need to set various filters in the solution.

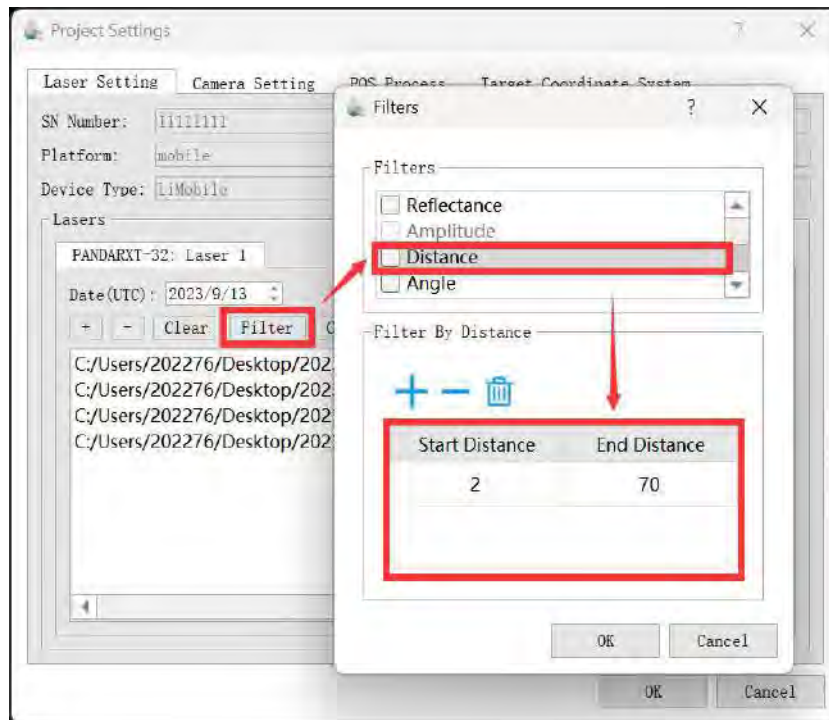

Tips: In practice, the laser will inevitably scan for noise at the rear of the car, so it is recommended to add a distance filtering option to eliminate this part of the noise and usually set it to 2m-70m.

(2) Camera Setting

First, click **MV-GC: Camera 1** button to select camera image folder and import the `hk_caminfo.txt` file. Then, click **ladybug5plus: Camera 2** button, select camera image folder, adjust the resolution to 8192*4096, and click **Convert PGR to JPG** button to get the `ladybug_caminfo.txt` file and panoramic images in *.jpg format..

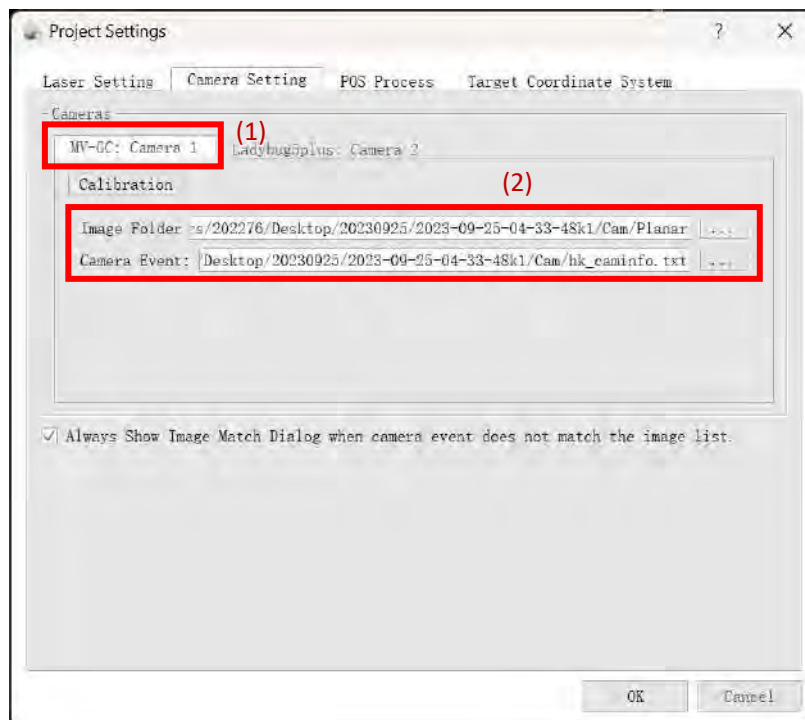

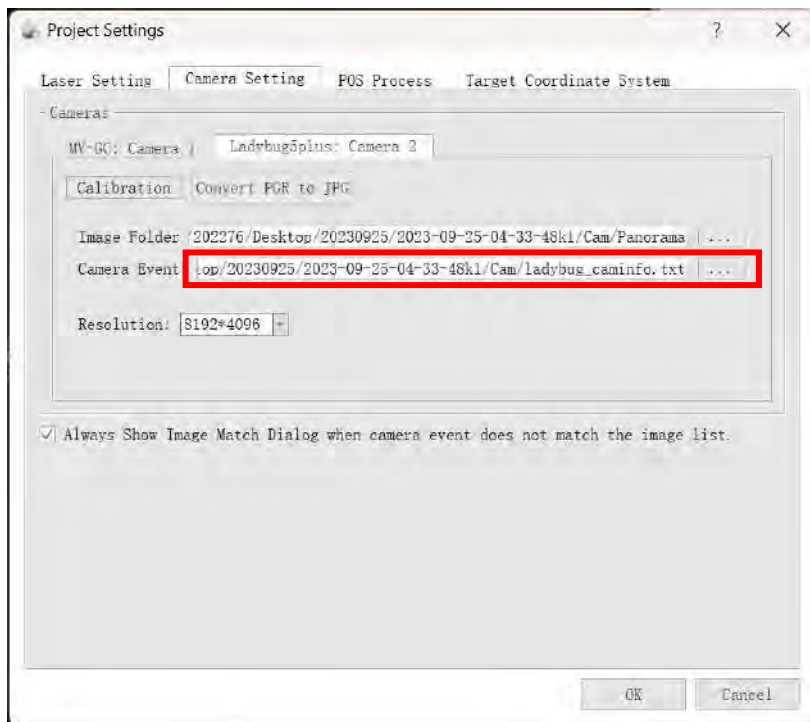
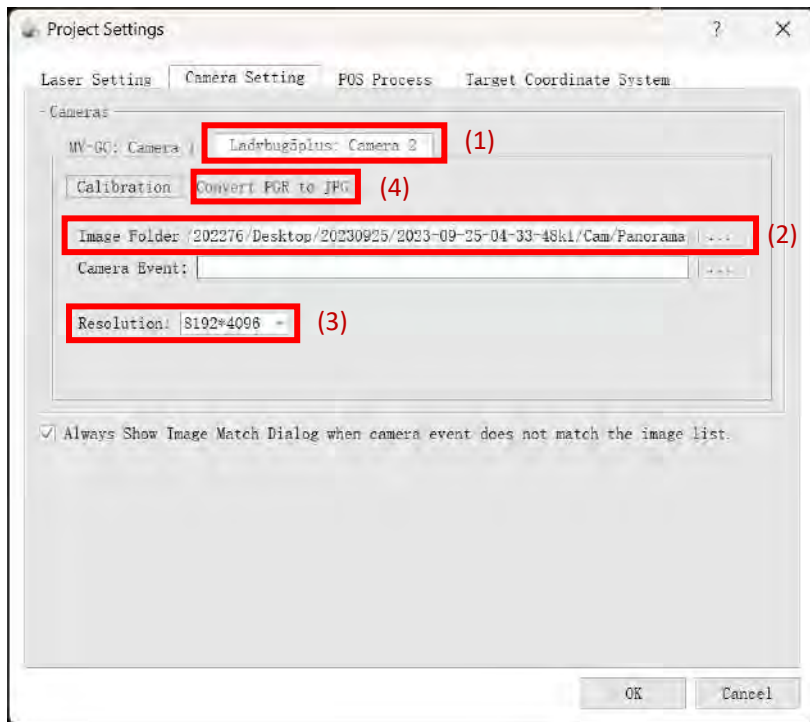

Tips: In general, the software can automatically recognize relevant files, and users can adjust the resolution according to their needs. If planar or panorama camera data is not collected, the user users are not required to specify the corresponding file path.

After the conversion, users should check whether the photos in the Panorama folder are clear, well-lit, and whether the number of photos matches the quantity recorded in the ladybug_caminfo.txt file.

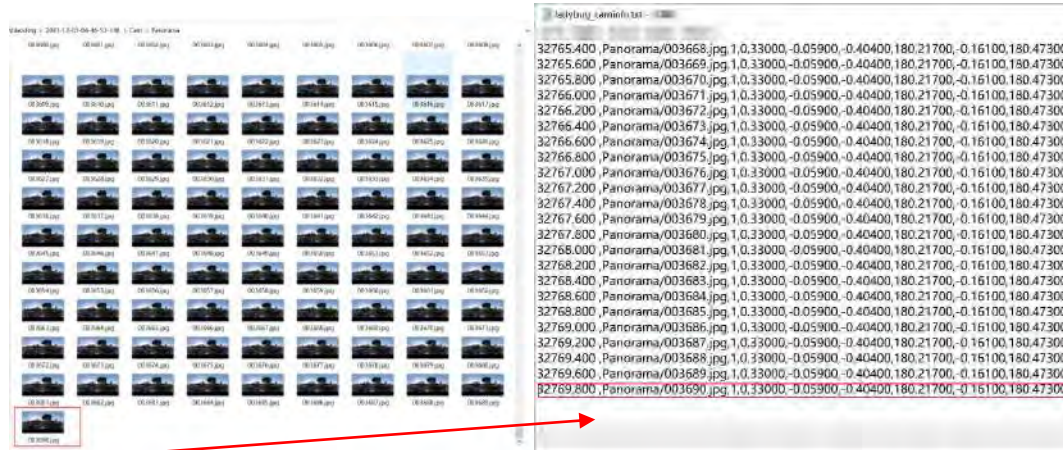

(3) POS Process

If users use LiGeoreference for POS process, they need to click the **LiNav** button, add the rover station data and the base station data files and select the location mode. As shown in the figure below, the base station data supports FindMM files, NovAtel base station data files, standard RINEX format base station files, RTCM3 files, GVRTCM3 files, and RTK files. Users can click the **RINEX** button and add the base station data files.

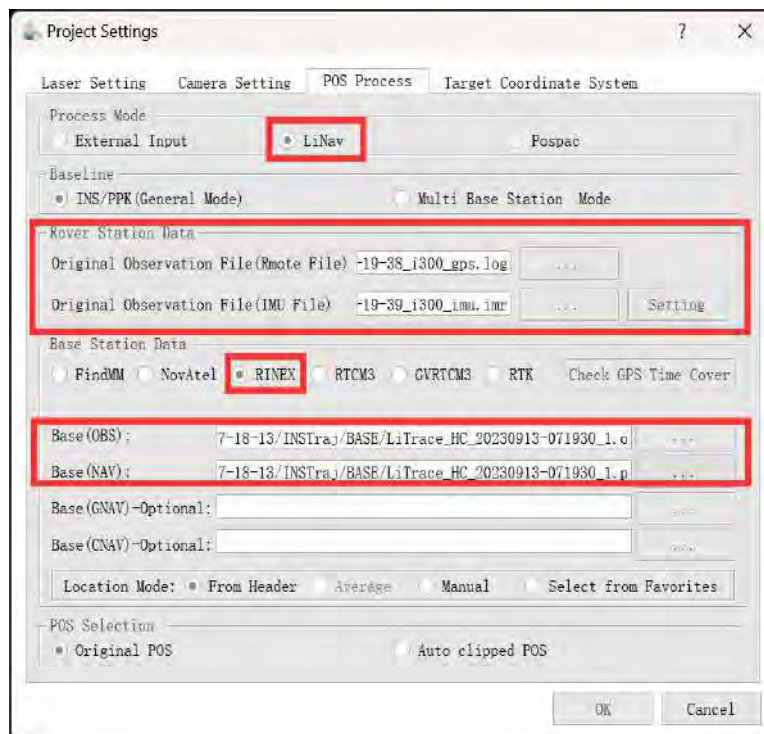

(4) Target Coordinate System

Users can set it according to their needs, and the default is WGS 84/UTM zone50N projection.

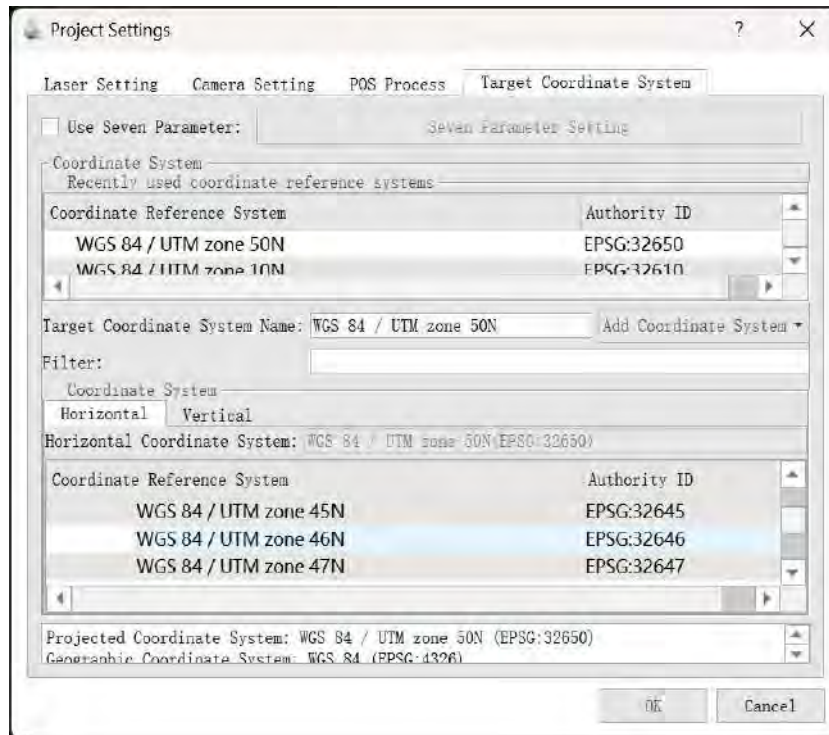

8.2.3 POS Processing

Users need to check the **POS Process** button and then click the **Start** button to initiate the processing. The processed trajectory is shown below. After the processing is completed, users can click the **Trajectory Report** button in the LiGeoreference's **Tools** module to generate a trajectory report for trajectory quality inspection.

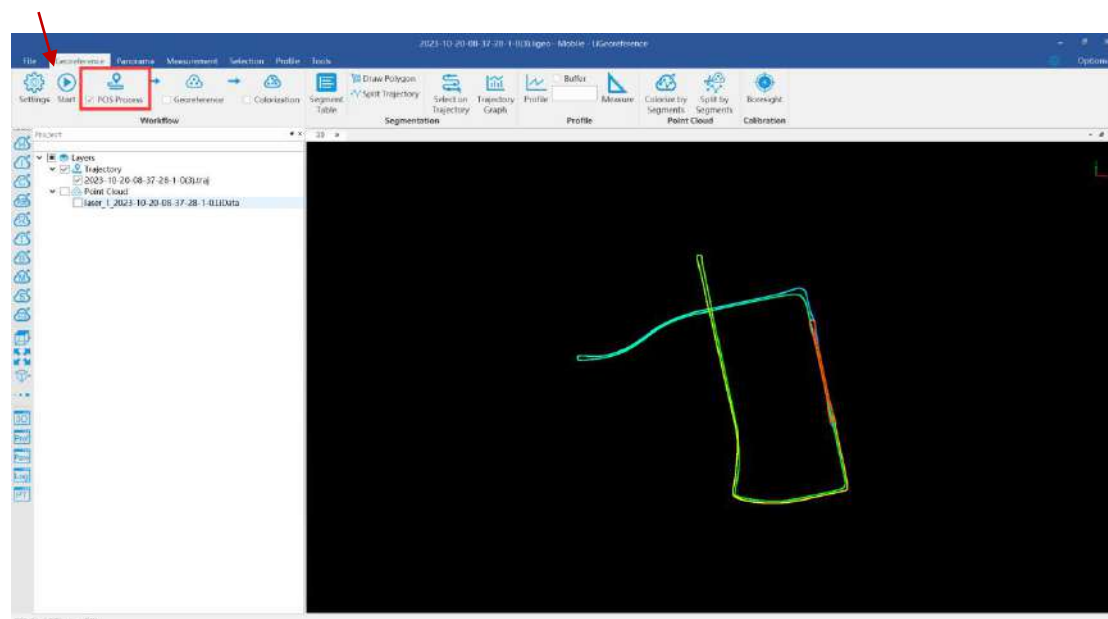

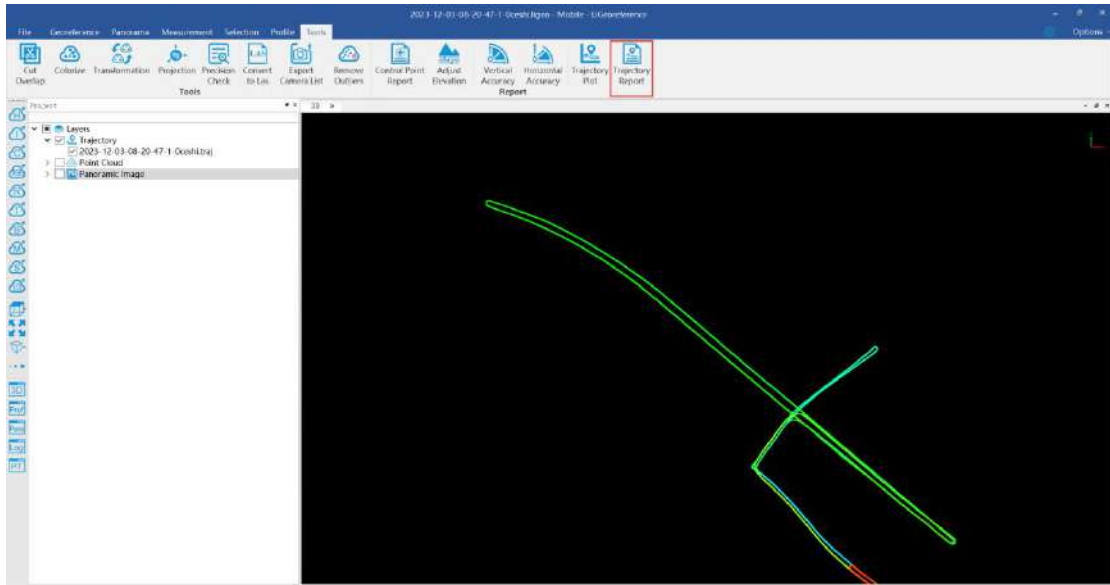

Quality Report

Figure 1. Number of Satellites Bar Plot



Figure 2. Float or Fixed Ambiguity Plot

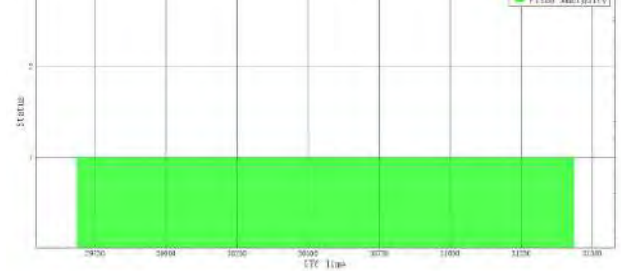
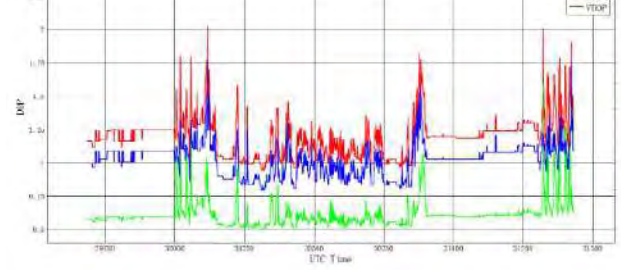
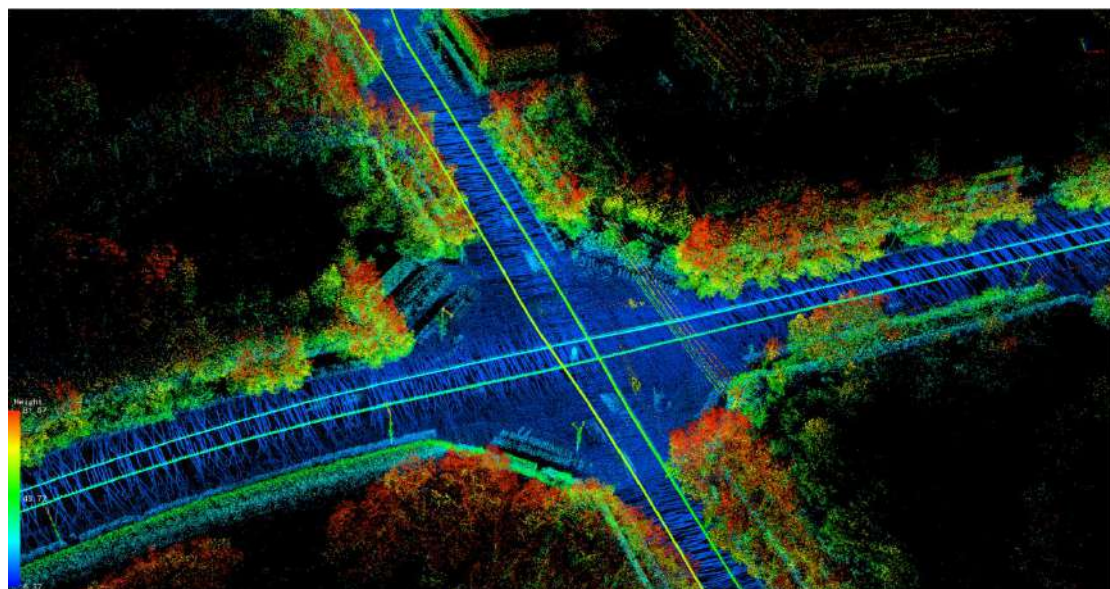
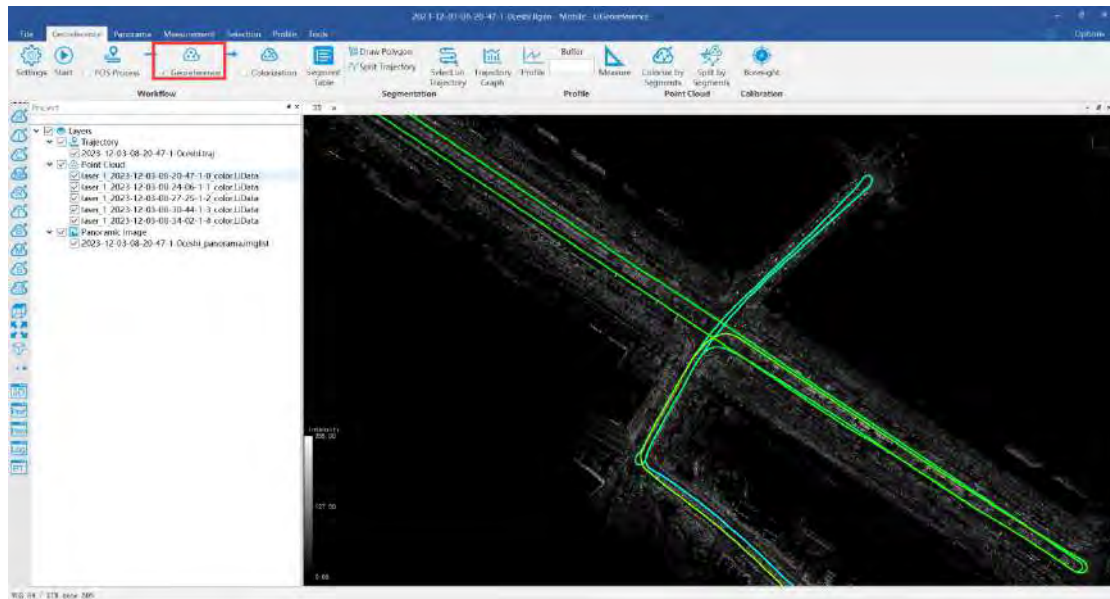

Figure 3. DOP Plot



8.2.4 Point Cloud Processing

Due to the continuous changes in the position and orientation of the vehicle during data collection, the raw data obtained by the LiDAR scanner is based on different coordinate systems at different time intervals. To give practical significance to the LiDAR scan data, it needs to be unified into a common reference coordinate system. The point cloud processing function in the LiGeoreference allows for coordinate alignment of the point cloud data. After visualizing the original vehicle-mounted LiDAR scan data, all the data points can be seen clustering along a ‘line’ or a ‘surface’. Users need to check the **Georeference** button and then click the **Start** button to initiate the processing. The resulting point cloud data after processing is shown below.



8.3 Point Cloud Quality Inspection and Improvement

After the point cloud data results are generated, users can use the **Profile** and **GCP Adjustment** in the LiDAR360 MLS software to validate the accuracy of the point cloud data results. Users can also use functions such as **GCP Adjustment** and **Strip Adjust** to adjust the

quality of the point cloud data. For more detailed operational steps, please refer to the LiDAR360 MLS User Guide.

8.3.1 Point Cloud Quality Inspection

(1) Profile View

Users can arbitrarily delineate a rectangular area in LiDAR360 MLS and display the side view of this area in an independent profile window to determine whether the point cloud data exhibits a layering phenomenon. This allows users to observe and measure from specific angles.

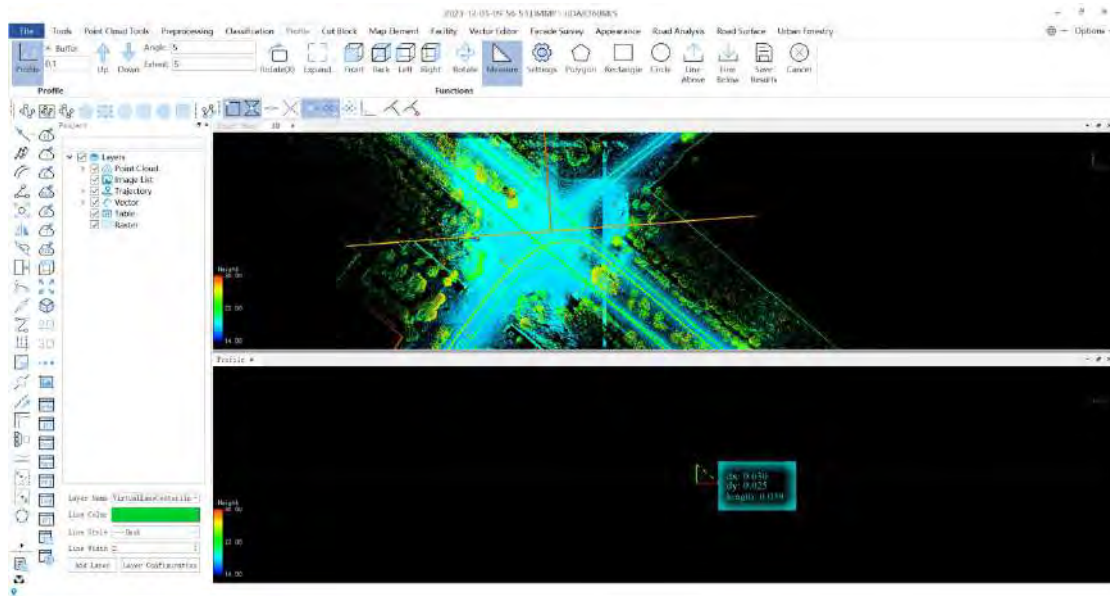

(2) GCP Inspection

Users can use GPS or total stations for plane control measurements and combine them with the **GCP Adjustment** function in the LiDAR360 MLS, import GCP files for absolute accuracy inspection.

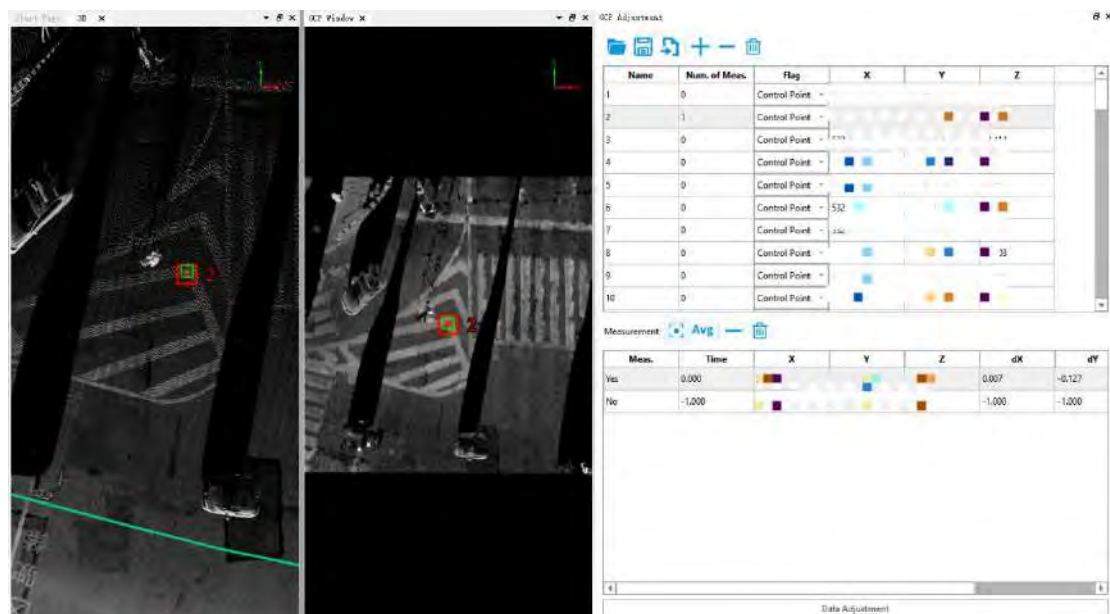

8.3.2 Point Cloud Quality Improvement

(1) GCP Adjustment

If there is a deviation between the GCPs and the pierced points, users can use the **GCP Adjustment** function of LiDAR360 MLS. Based on the pierced point information, adjustment parameters are calculated to locally or single-pass adjust on the processed data from LiMobile M1, as shown below.

The 'Data Adjustment' dialog box contains the following elements:

- Settings:** A 'Mode' section with three radio buttons: 'XYZ' (selected), 'XY', and 'Z'. To the right is a 'Control Point Time Range(s):' field with a numeric input set to '5.000' and a spin control.
- Result:** A section titled 'Residual error of Check Points' containing a table with the following headers: 'Name', 'XOffset', 'YOffset', 'ZOffset', and 'abs(XYZ)'. The table body is currently empty. Below the table are two rows of input fields: 'Min_ΔX', 'Min_ΔY', 'Min_ΔZ', 'RMSE_XY', 'Max_ΔX', 'Max_ΔY', 'Max_ΔZ', and 'RMSE_Z'. At the bottom of this section are two buttons: 'Calculate' and 'Report'.
- Apply:** A section with three checked checkboxes: 'Apply to Trajectory', 'Apply to Point Cloud', and 'Apply to Image List'. To the right is an 'OK' button.

(2) Strip Adjust

If there is a slight layering in the data, users can use the **Strip Adjust** function in LiDAR360 MLS. This function supports the adjustment of the point cloud revisit area within a single project of vehicle-mounted data, and it also supports the participation of GCPs in the adjustment.

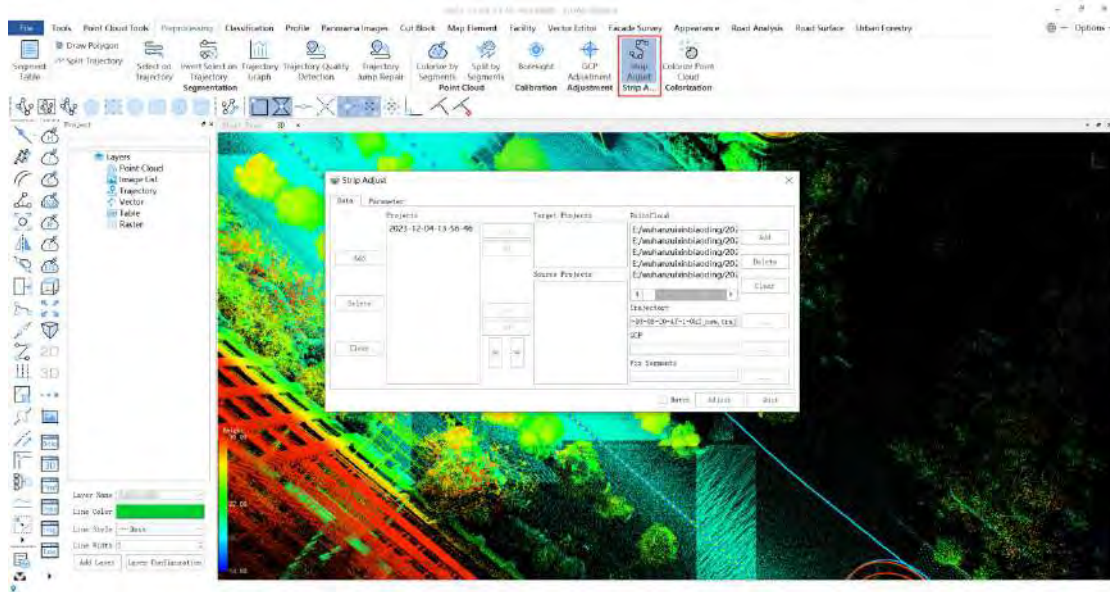

8.4 Point Cloud and Planar Image Overlay Display

Users can observe the overlay display of point cloud and planar image data in LiDAR360 MLS.

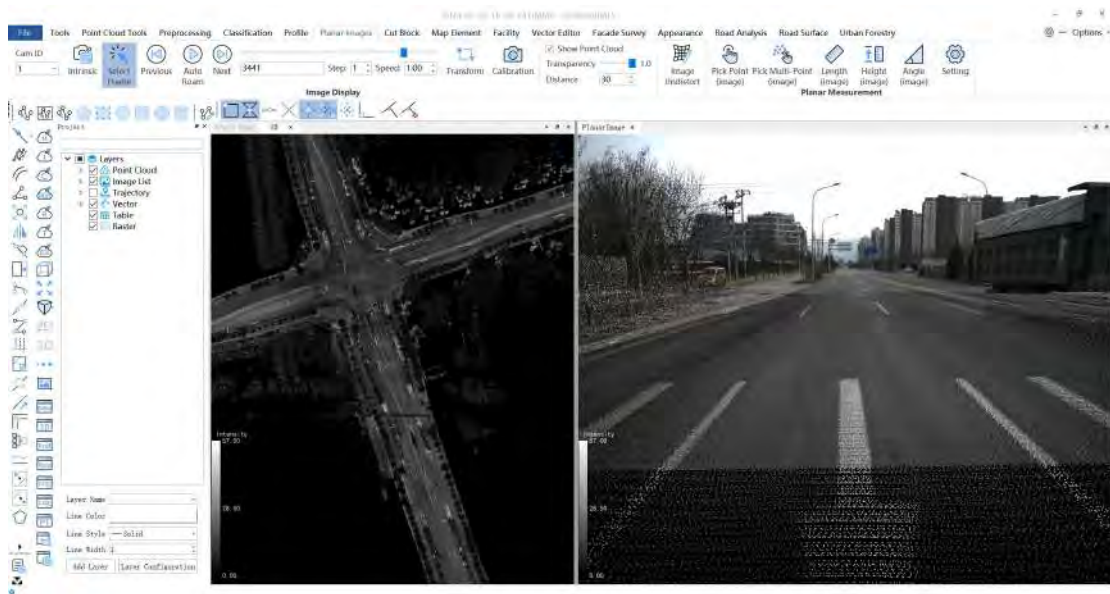

8.5 Point Cloud and Panoramic Image Fusion Quality Inspection

8.5.1 Quality Inspection

By Fusing point cloud with panoramic image data, corresponding pixel positions of the point cloud in the panoramic image can be identified, enabling colorization of the point cloud. Users can observe the overlay display of point cloud and panoramic image data in LiDAR360 MLS. In case of slight deviations, the **Transform** tool can be used for adjustment. After making adjustments, click the **Apply All** button to preview the adjustment effects. Once confirmed, click the **Save All** button.

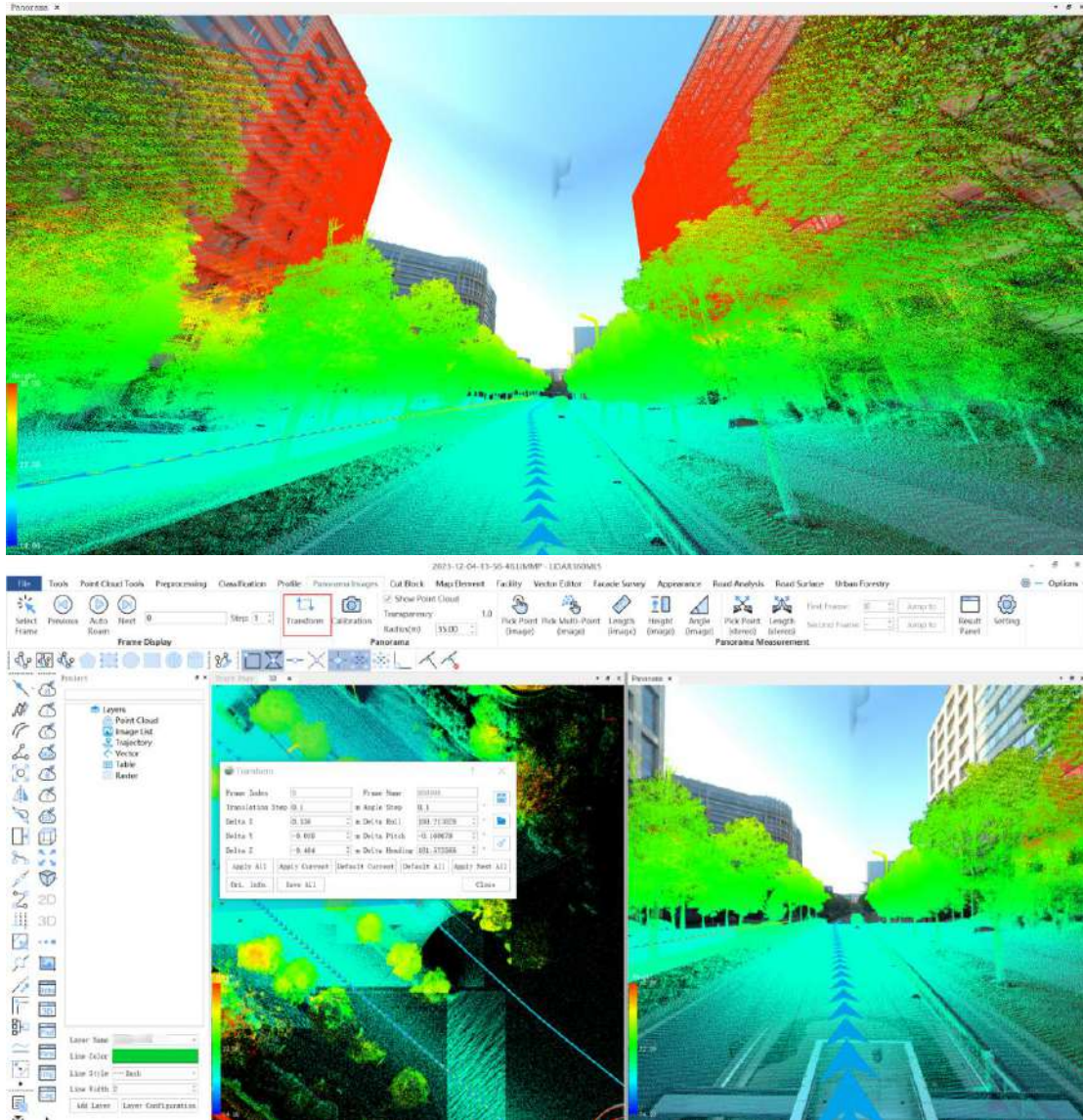

8.5.2 Point Cloud Colorization

The ***Colorize Point Cloud*** function in the LiDAR360 MLS allows users to visually display color information in the 3D model, enhancing the realism and visualization of the scene. Users need to first create a mask file and add the file path. The mask file format is shown below. Then, users can independently choose the coloring mode, such as ***Color by Time*** or ***Color by Distance***, according to the needs. For detailed instructions, please refer to the LiDAR360 MLS User Guide. After colorization is complete, users should verify if the object colors are correct and if the edges of the lane lines are continuous without breaks.

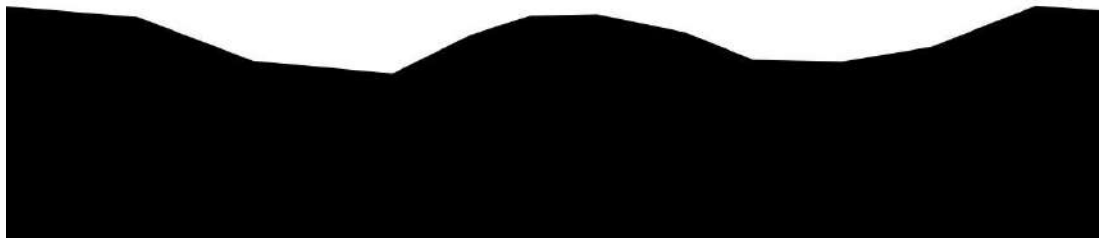
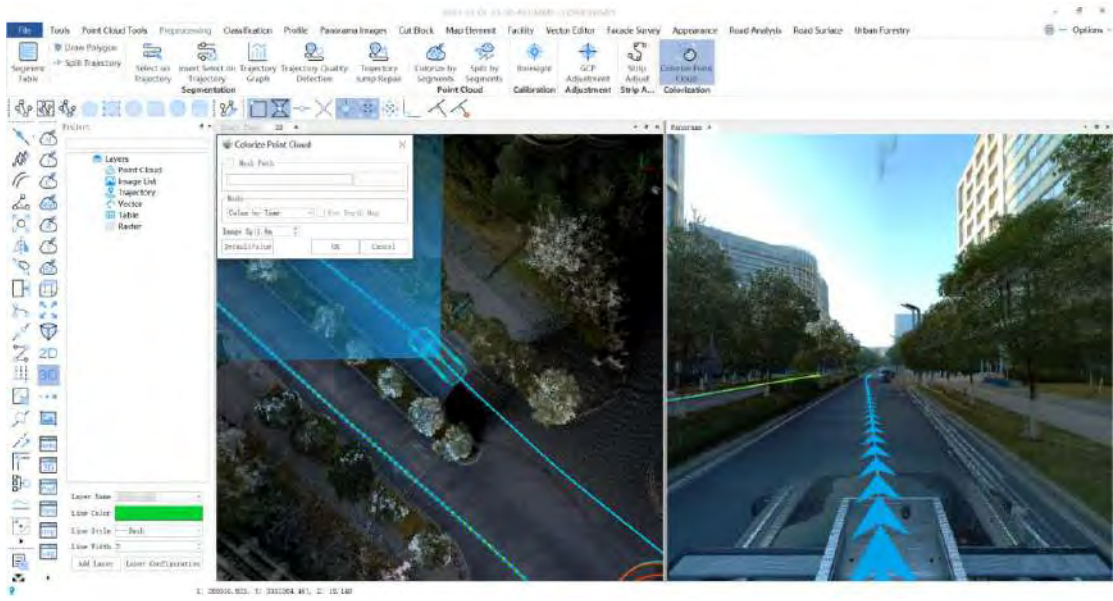

9 Frequently Asked Questions

(1) Why is there no Wi-Fi signal of LiMobile M1 after the tablet is turned on?

Please check whether the Wi-Fi antenna is connected normally. If the connection is normal, there should be a Wi-Fi signal named 'LiMobileM1_XXXX' after 1 minute of starting the main body. If the signal has not been found for more than 1 minute, it may be due to the slow startup of the tablet. If the signal has not been found for more than 5 minutes, please disconnect the power, restart the computer, and then search for the Wi-Fi signal.

(2) Why do not the laser scanner and the computer start after powering on the LiMobile M1 system?

Please check whether the battery power is sufficient and whether the battery cable is connected.

Please avoid over-discharge, so as not to damage the battery.

It is recommended to stop the collection operation when the battery percentage is lower than 30%. Please replace the battery or fully charge the battery. Also ensure that the power cable is disconnected when the device is turned off.

(3) What should I do when LiMobile M1 Wi-Fi is found but the UI device cannot connect to it?

It is recommended to use the mobile device provided by GVI for data collection.

(4) Does LiMobile M1 come with point cloud post-processing tools?

We recommend using LiDAR360 MLS, a comprehensive LiDAR point cloud data post-processing suite independently developed by GVI, for data visualization, processing, and analysis. This software enables one-stop data processing to deliver industry results.

(5) Is the output point cloud calibrated to be vertical to the ground?

LiMobile M1 will perform tilt correction based on IMU data by default during point cloud processing. The tilt angle accuracy is in range of 1~3 degrees.

(6) Why is the point cloud layered in repeated scans?

The layering of point cloud data may be affected by many factors. First, check the parameters such as lever arm value, and then check the trajectory accuracy of multiple scans at the layered location. If there are a small number of satellites, the trajectory accuracy is low, it may affect point cloud data quality.

(7) How long can I scan with LiMobile M1 on one battery charge?

A fully charged LiMobile device can support 4 hours of uninterrupted data collection.

(8) What are the recommended operation environment and conditions for LiMobile?

Operation of the system should be carried out when ambient temperatures are within the -20°C to 65°C range. You should avoid operating the LiMobile M1 outdoors on wet-weather conditions.

(9) What is the ANSI Laser Safety Standard rating of LiMobile M1's LiDAR sensor?

ANSI Laser Safety Standard rating of LiMobile M1 is Class-1 (eye-safe).

(10) Is my data collected with LiMobile secure?

All data collected by LiMobile M1 is only stored in the device and will not be uploaded to the network. If you encounter any difficulties with real-time data processing, please contact us at info@lidar360.com and send us the data with its documentations. We will post-process your data to produce high accuracy point cloud.

10 Appendix

At present, LiMobile M1 is mainly applied in outdoor scenes (e.g. roads) to provide raw point cloud data for high-precision mapping. The data display adopts LiDAR360 MLS software. The software supports conventional display modes such as height, intensity, classification, return, etc., along with EDL and GLASS special effect display for the best data display effects.



Road True-color View

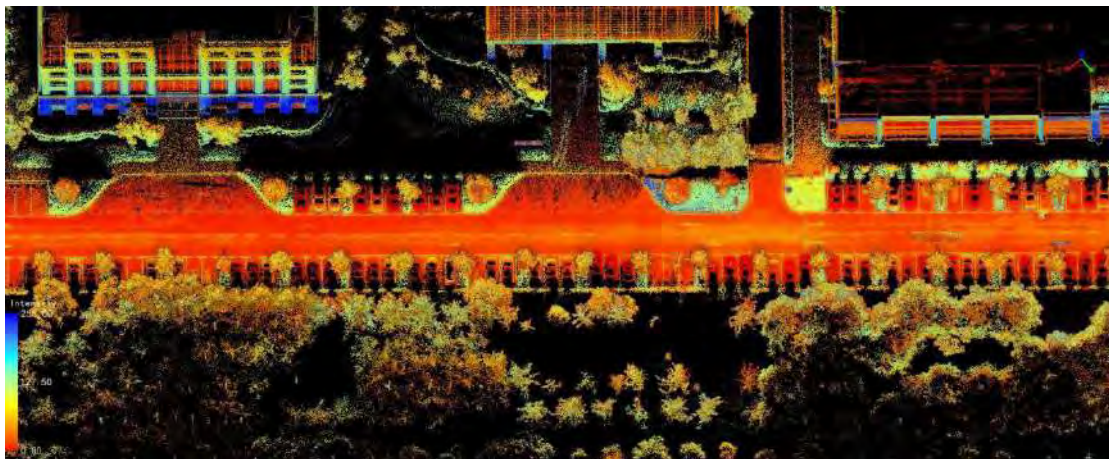

Road Elevation View

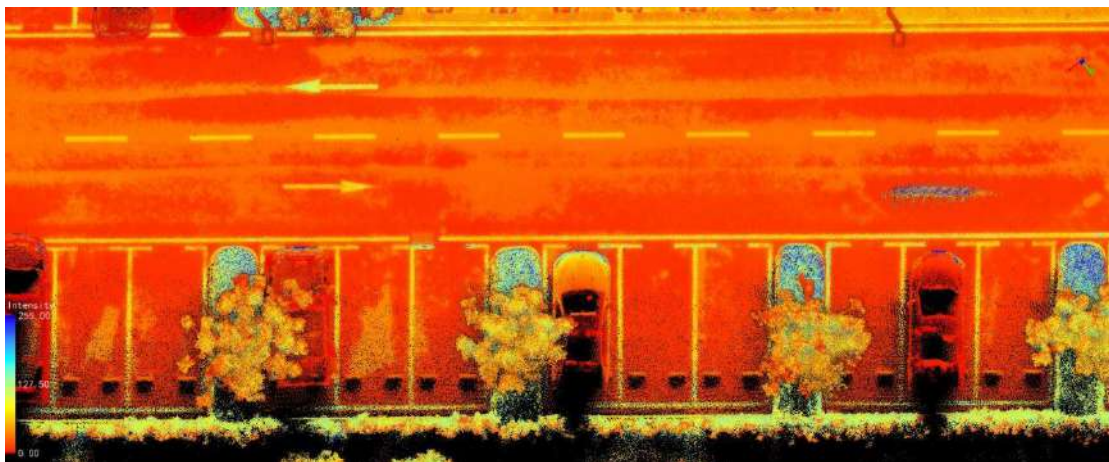

Road Sign Elevation+Black-and-White View



Cross-Roads True-color View

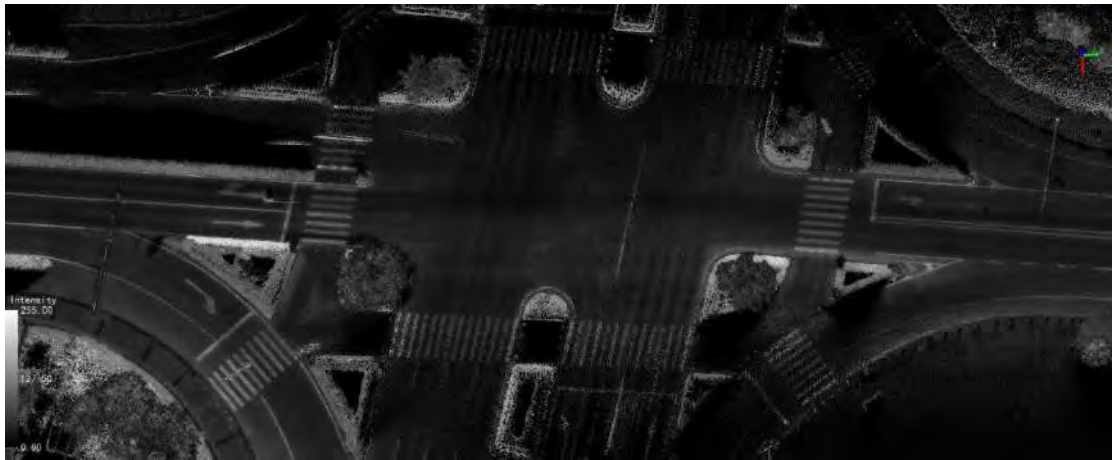

Cross-Roads Black-and-White View

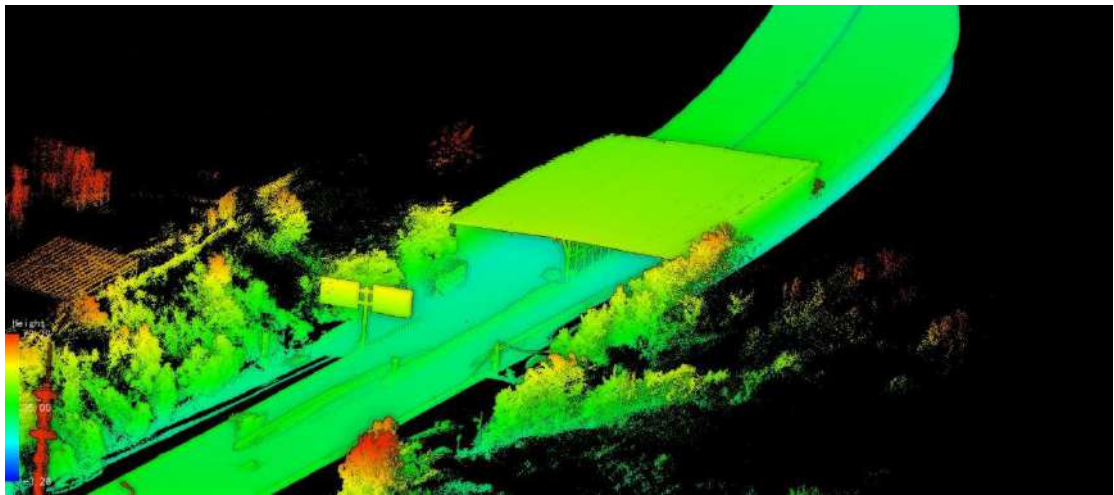

Tunnel Elevation View