

# **dji** DOCK 2

## MATRICE 3D SERIES

Unmanned Aircraft Flight Manual

v1.0 2024.04

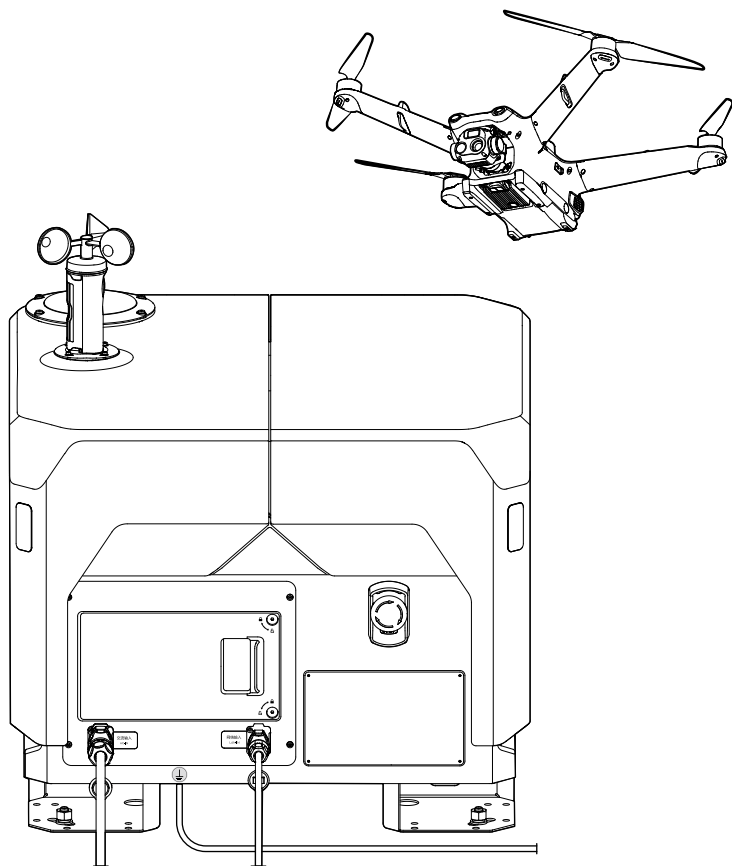



This document is copyrighted by DJI with all rights reserved. Unless otherwise authorized by DJI, you are not eligible to use or allow others to use the document or any part of the document by reproducing, transferring, or selling the document. Users should only refer to this document and the content thereof as instructions to operate DJI UAV. The document should not be used for other purposes.

### **Searching for Keywords**

Search for keywords such as “battery” and “install” to find a topic. If you are using Adobe Acrobat Reader to read this document, press Ctrl+F on Windows or Command+F on Mac to begin a search.

### **Navigating to a Topic**

View a complete list of topics in the table of contents. Click on a topic to navigate to that section.

### **Printing this Document**

This document supports high resolution printing.

## **Revision Log**

Version	Date	Revisions
v1.0	2024.04	Initial release

This document was developed following the process, content and structure defined in ASTM Specification F2908.

# Using this Manual

## Legend

⚠ Important

💡 Hints and Tips

## Read Before Use

DJI™ provides users with tutorial videos and the following documents:

1. Safety Guidelines
2. Quick Installation Guide
3. Installation and Setup Manual
4. User Manual (Unmanned Aircraft Flight Manual)

It is recommended to watch all tutorial videos and read the Safety Guidelines before using for the first time. Prepare for dock installation and first flight by reviewing the Quick Installation Guide. Refer to the Installation and Setup Manual and this manual for more information.

- 
- ⚠ • The dock must be installed and set up by an authorized service provider. Unauthorized installation and setup may lead to safety risks. Contact DJI Support for information on authorized service providers.
- 

## Download DJI Assistant 2

Download and install DJI ASSISTANT™ 2 (Enterprise Series) using the link below:

<https://enterprise.dji.com/dock-2/downloads>

## Video Tutorials

Go to the address below or scan the QR code to watch the tutorial videos, which demonstrate how to use the product safely.



<https://enterprise.dji.com/dock-2/video>

-  • The operating temperature of the dock is -25° to 45° C (-13° to 113° F), <sup>[1]</sup> and the operating temperature of the aircraft is -20° to 45° C (-4° to 113° F). It does not meet the standard operating temperature for military-grade application (-55° to 125° C / -67° to 257° F), which is required to endure greater environmental variability. Use the product for applications that meet the operating temperature range requirements of that grade.

---

[1] When the temperature is below -20° C (-4° F), the aircraft cannot perform flight tasks.

# Contents

<b>Using this Manual</b>	<b>3</b>
Legend	3
Read Before Use	3
Download DJI Assistant 2	3
Video Tutorials	3
<b>General Information and System Description</b>	<b>9</b>
Introduction	9
Feature Highlights	9
Aircraft	11
Aircraft Indicators	12
Beacon and Auxiliary Light	13
Cameras	14
Gimbal	17
Flight Control Surfaces	18
Propulsion System	18
Avionics	18
Intelligent Flight Battery	25
Control Station	29
Profile	29
Dock	29
DJI FlightHub 2 (Information Display and User Interface)	40
Remote Controller (Sold Separately)	48
Command and Control Link (C2 Link)	52
Ground Operational Area Setup	52
<b>Performance and Limitations</b>	<b>54</b>
Performance	54
Prohibited Actions	54
Center of Gravity Limitations	55
<b>Normal Procedures</b>	<b>57</b>
Airspace Environment	57
Operating Environment	57
Flight Restrictions and Unlocking	57
Radio Frequency Environment	61
Use of Takeoff and Landing Equipment	61

Distance to Control Station	61
System Assembly	63
Pre-Flight Checklist	63
On-site Checklist	63
DJI FlightHub 2 Checklist	64
System Starting	65
Powering on/off the Aircraft	65
Connecting the dock and the aircraft	66
Calibrating the Dock RTK	66
Connecting the Remote Controller as Controller B	67
Aircraft Settings Using the Remote Controller	68
Calibrating the Aircraft	68
Takeoff/Landing	70
Automatic Takeoff/Landing	70
Manual Takeoff/Landing	70
Planned and Manual Flight	72
Flight Procedure	72
Flight Route Tasks	72
Live Flight Controls	73
On-site Flight Controls	73
Flight Modes	74
RTH75	
Advanced RTH	76
Dock Landing Detection	82
System Shutdown	82
Post-Flight Inspection	83
<b>Emergency Procedures</b>	<b>85</b>
General Information	85
Fire	85
Loss of C2 Link	85
Loss of Navigation Systems	85
Control Station Failures	86
Loss of Control Signal	86
DJI FlightHub 2 Failure	86

Alternate Landing	86
Gaining Control Using Remote Controller B	87
Emergency Stop Button	88
Other Failures	89
Flyaway	89
<b>Handling, Servicing and Instructions for Maintenance</b>	<b>91</b>
Ground Handling	91
Installation, Removal, and Storage	91
Installation and Removal	91
Storage	93
IP Rating	93
Charging, Conditioning, and Replacing Batteries	94
Charging Batteries	94
Conditioning Batteries	96
Replacing Batteries	97
Cleaning and Maintaining	97
<b>Supplements</b>	<b>99</b>
Specifications	99
Dock	99
Aircraft	102
Firmware Update	109
Using DJI FlightHub 2	109
Using DJI Assistant 2 (Enterprise Series)	109
Expansion Ports	110
Third-Party Payload Requirements	110
Installation Requirements	110
Third-Party Cloud Platform	111
FAR Remote ID Compliance Information	111

# General Information and System Description

---



# General Information and System Description

## Introduction

DJI Dock 2 is a compact and high-performance, automated operation platform. The dock adopts a lightweight design and can be carried by two people, and the highly integrated body design allows quick installation and configuration. Dock site evaluation can be completed within 12 minutes with the help of vision evaluation technology. The dock can achieve a protection level of IP55 (refer to IEC 60529 standard). The longest maintenance interval is six months. <sup>[1]</sup> The dock comes with a quick-charging module and an air conditioning system, allowing it to cool down and charge the battery in a short time. It takes approximately 32 minutes to charge the battery from 20% to 90%. <sup>[2]</sup>

DJI MATRICE™ 3D Series aircraft is equipped with a six-directional vision system and an infrared sensing system, <sup>[3]</sup> supporting RTH and obstacle sensing. The internal RTK facilitates accurate, high-precision operations and meets the need of improved flight safety. The aircraft has a protection level of IP54 (refer to IEC 60529 standard).

DJI FLIGHTHUB™ 2 is a cloud-based aircraft task management platform, and can work with DJI Dock 2 and DJI Matrice 3D Series aircraft to perform automated operations, achieving efficient flight task and device management.

- [1] Actual maintenance intervals should be determined based on the deployment environment and operating frequency. It is recommended to conduct maintenance every six months or less.
- [2] This data is from tests at a room temperature of 25° C (77° F) where the battery was charged from 20% to 90% when the aircraft was powered off, and should be used for reference only.
- [3] The vision system and the infrared sensing systems are affected by surrounding conditions. Refer to the Vision System and Infrared Sensing System section for more information.

## Feature Highlights

**Lightweight Design:** DJI Dock 2 weighs approximately 34 kg and can be transported by two individuals, significantly increasing installation flexibility while reducing installation costs.

**Quick Takeoff Ability:** The dock integrates dual RTK modules, allowing the aircraft to quickly take off without waiting for the RTK data to converge. A complete propeller inspection and takeoff happens all within approximately 45 seconds. <sup>[1]</sup>

**Gimbal Cameras:** DJI Matrice 3D has a tele camera and a wide-angle camera with a mechanical shutter, meeting the needs of high-precision mapping tasks. DJI Matrice 3TD has a wide-angle camera, a tele camera, and an infrared camera and can depict both visible light and thermal images, making it suitable for security and inspection operations.

The tele camera supports up to 56× Max Hybrid Zoom, allowing for a highly magnified zoom view from a remote distance. The infrared camera and the tele camera of Matrice 3TD supports 28× continuous side-by-side zoom for easy comparison.

**Cloud Mapping:** DJI FlightHub 2 can generate high-precision 3D models based on the collected flight data, restoring the operating environment authentically. Utilizing high-precision 3D models, users can perform flight route editing from a first-person perspective and preview simulated imaging results, enhancing flight route planning accuracy.

**Cloud-Based Operation:** DJI FlightHub 2 supports flight task planning, live flight controls, and device management for the dock. Users can set flight task plans based on actual needs. The

aircraft will automatically take off according to the preset task plans, and the media files will be automatically uploaded to DJI FlightHub 2. Users can also gain control and control the aircraft, gimbal, and payload remotely. During operation, livestreams, and real-time device information can be viewed remotely to monitor the operation site. Users can also perform remote debugging, making device management more convenient.

- [1] In an environment with good network connection, it takes approximately 45 seconds at the fastest from when the operator clicks Take Off in DJI FlightHub 2 to when the aircraft leaves the landing pad. This value is for reference only, and the actual experience may vary.

## Aircraft

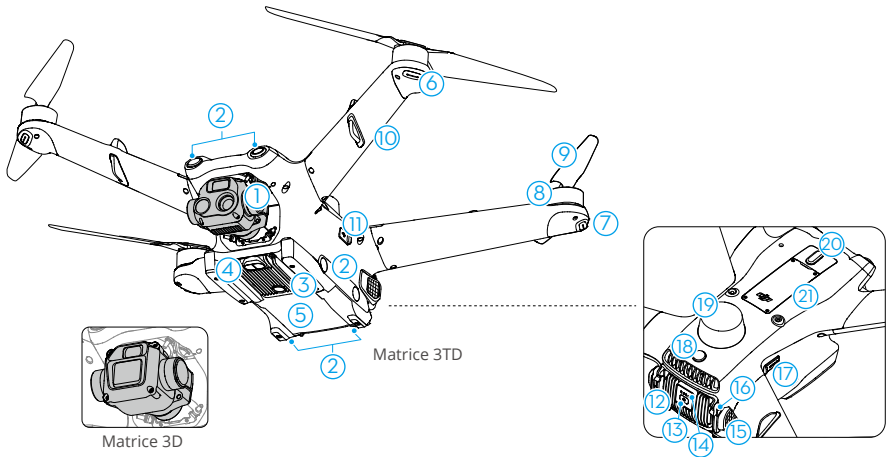

- |  |                                |
|--|--------------------------------|
| 1. Gimbal Camera <sup>[1]</sup>          | 12. Intelligent Flight Battery |
| 2. Vision System                         | 13. Power Button               |
| 3. Auxiliary Light                       | 14. Battery Level LEDs         |
| 4. Infrared Sensing System               | 15. Battery Buckle             |
| 5. Internal Charging Modules             | 16. Battery Locking Arm        |
| 6. Front LEDs                            | 17. microSD Card Slot          |
| 7. Aircraft Status Indicators            | 18. Beacon                     |
| 8. Motors                                | 19. GNSS/RTK Antenna           |
| 9. Propellers                            | 20. E-Port                     |
| 10. Frame Arms (incl. internal antennas) | 21. Dongle Compartment         |
| 11. USB-C Assistant Port (E-Port Lite)   |                                |

- ⚠** • Contact DJI or a DJI authorized dealer to replace the components of the product if damaged. DO NOT disassemble the product without the assistance of a DJI authorized dealer (except for components allowed to be disassembled by users in this manual), otherwise it will not be covered under warranty.
- The aircraft has particle dampers installed in the LED covers at the end of the frame arms to dampen frame arm vibration, ensuring a reliable, extended flight time in various environments. It is normal for the particle dampers to make a sound when shaken.

[1] DJI Matrice 3D and DJI Matrice 3TD are equipped with different cameras. Refer to the actual product purchased.

## Aircraft Indicators

The aircraft has front LEDs and aircraft status indicators.

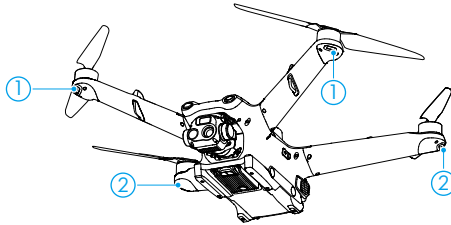

1. Front LEDs
2. Aircraft Status Indicator

When the aircraft is powered on but the motors are not running, the front LEDs glow solid red to display the orientation of the aircraft.

When the aircraft is powered on, but the motors are not running, the aircraft status indicators will display the current status of the flight control system. Refer to the table below for more information about the aircraft status indicators.

### Aircraft Status Indicator Descriptions

Normal States		
	Blinks red, yellow, and green in alternate	Powering on and performing self-diagnostic tests
	×4	Blinks yellow four times
	.....	Blinks green slowly <sup>[1]</sup>
	×2 .....	Blinks green twice repeatedly <sup>[1]</sup>
	.....	Blinks yellow slowly
		GNSS and vision system disabled (ATTI mode enabled)
Warning States		
	.....	Blinks yellow quickly
		Control signal lost
	.....	Blinks red slowly
		Takeoff is disabled, e.g. low battery <sup>[2]</sup>
	.....	Blinks red quickly
		Critically low battery
	—	Solid red
		Critical error
	.....	Blinks red and yellow in alternate
		Compass calibration required

[1] Blinks green slowly in N-mode and quickly in S-mode.

[2] If the aircraft cannot take off while the aircraft status indicators blink red slowly, open DJI FlightHub 2 Project page and check the device status.

After the motors start, the front LEDs will blink red and green alternately and the aircraft status indicators will blink green. The green lights indicate the aircraft is a UAV and the red lights indicate the heading and position of the aircraft.

- 
- ⚠ • To obtain better footage, the front LEDs will turn off automatically when taking photos or videos by default. Front LED settings can be modified in DJI Pilot 2. Lighting requirements vary depending on the region. Observe local laws and regulations.
- 

## Beacon and Auxiliary Light

### Beacon

The beacon on the aircraft allows users to find the aircraft when flying at night. The beacon can be enabled/disabled in DJI FlightHub 2 > Devices > Dock > Device Maintenance.

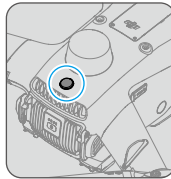

- 
- ⚠ • DO NOT look directly at the beacon when it is in use to avoid eye damage.
- 

### Auxiliary Light

The auxiliary light is located at the bottom of the aircraft and will automatically turn on in low-light environments to assist the downward vision system.

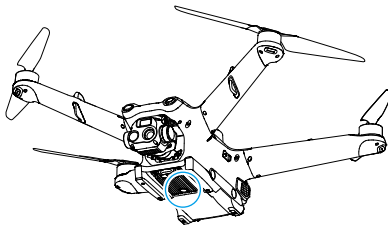

- 
- ⚠ • The auxiliary light will automatically turn on in low-light environments when the flight altitude is under 5 m. Note that the positioning performance of the vision system may be affected. Fly with caution if the GNSS signal is weak. Pay attention to the dock and the aircraft livestream.
-

## Cameras

### Camera Profile

DJI Matrice 3D has a tele camera and a wide-angle camera and is suitable for high-precision mapping tasks. DJI Matrice 3TD has a wide-angle camera, a tele camera, and an infrared camera that can take thermal photos and is suitable for security and inspection operations.

Having a zoom camera and a wide-angle camera enables users to quickly switch to a highly magnified zoom view for detailed observation after recognizing an object in the wide-angle camera view.

The zoom camera and the tele camera feature lens defogging. After powering on, the zoom camera will automatically heat the lens to dissipate the moisture on the lens.

The infrared camera features sunburn protection. When the camera detects direct sunlight, the infrared shutter will turn off automatically to protect the infrared sensors.

### Matrice 3D

DJI Matrice 3D features a tele camera and a wide-angle camera with a mechanical shutter, meeting the needs of high-precision mapping tasks.

The 4/3 CMOS, 20MP RGB wide-angle camera has a mechanical shutter to prevent motion blur and supports rapid 0.7-second interval shooting. Large 3.3 $\mu$ m pixels together with Smart Low-Light Photo offer significantly improved photo quality in dim conditions.

The tele camera boasts a 1/2-in CMOS sensor, capable of taking 48MP photos with an aperture of f/4.4 and shooting at 3 m to infinity, supporting up to 56 $\times$  Max Hybrid Zoom.

### Matrice 3TD

The wide-angle camera of Matrice 3TD boasts a 1/1.32-in CMOS sensor, capable of taking 48MP photos with an aperture of f/1.7 and shooting at 1 m to infinity.

The tele camera boasts a 1/2-in CMOS sensor, capable of taking 48MP photos with an aperture of f/4.4 and shooting at 3 m to infinity, supporting up to 56 $\times$  Max Hybrid Zoom.

The infrared camera has 640 $\times$ 512 resolution and, together with the tele camera, supports 28 $\times$  continuous side-by-side zoom for easy comparison.

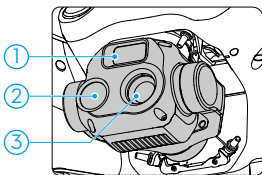

Matrice 3TD

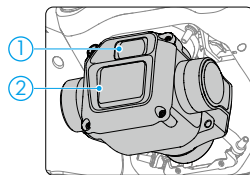

Matrice 3D

1. Tele Camera
2. Wide-angle Camera
3. Infrared Camera

- ⚠ • Due to the characteristics of the infrared sensor, the infrared sensor may become burnt before sunburn protection is triggered. DO NOT expose the infrared camera lenses to strong sources of energy such as the sun, lava, or laser beams. Otherwise, the camera sensor may become burnt, leading to permanent damage.
  - Make sure the temperature is within a suitable range for the camera during use and storage.
  - Use a lens cleaner to clean the lens to avoid damage or poor image quality.
  - DO NOT block any ventilation holes on the camera as the heat generated may damage the device or cause injury to the user.
- 

## Camera Operation

Users can designate waypoint actions when planning flight routes in DJI FlightHub 2. The aircraft will automatically hover, take photos, and record videos according to the waypoint actions during flight. Waypoints and waypoint actions can be edited in the FPV view to achieve more accurate flight route planning. Users can control the gimbal camera remotely after gaining gimbal camera control in DJI FlightHub 2. Go to the DJI FlightHub 2 User Guide and then refer to the Edit Waypoint Routes section for more information.

## Aircraft Livestream

The aircraft livestream function can be activated in DJI FlightHub 2 to view real-time flight information. Users can switch to different camera views or start recording in the aircraft livestream view. The recorded video will automatically be stored in Media Files in DJI FlightHub 2. Refer to the Device Status Window section for more information.

## Storing Media Files

A microSD card is inserted when shipped. The aircraft supports microSD cards with a maximum capacity of up to 512 GB. To ensure that the camera can quickly read and write data for HD video recording, use a microSD card with UHS Speed Class 3 or above and a write speed greater than 30 MB/s. Refer to the Specifications section for more information on recommended microSD cards.

- ⚠ • DO NOT remove the microSD card from the aircraft while recording. DO NOT remove the microSD card from the aircraft while taking photos or videos. Otherwise, the microSD card may be damaged.
  - Make sure to power off the aircraft correctly. Otherwise, the camera parameters will not be saved, and any recorded videos may be affected. DJI is not responsible for any loss caused by an image or video recorded in a way that is not machine-readable.
-

- ☀️ • Check the camera settings before use to ensure they are configured correctly.
  - Before taking important photos or videos, take a few photos to test whether the camera is operating correctly.
  - The photos and videos will be automatically uploaded to DJI FlightHub 2 after each flight task. Open the DJI FlightHub 2 Project page and click  > Media Files to view the uploaded files.
  - To ensure the stability of the camera system, single video recordings are limited to 30 minutes. If the recording time exceeds 30 minutes, the video recording will stop.
-



## Gimbal

### Gimbal Profile

The 3-axis gimbal provides stabilization for the camera, allowing users to capture a clear and stable picture. The control tilt range is  $-90^{\circ}$  to  $+35^{\circ}$

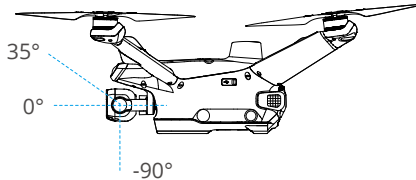

### Setting Gimbal Actions

The gimbal angle at each waypoint can be set in DJI FlightHub 2 when editing a flight route. The gimbal orientation can be adjusted remotely after gaining the gimbal camera control in DJI FlightHub 2. Go to the DJI FlightHub 2 User Guide and then refer to the Edit Waypoint Routes section for more information.

### Gimbal Mode

The gimbal operates in Follow Mode: The tilt angle of the gimbal remains stable relative to the horizontal plane, which is suitable for taking stable images. Users can adjust the gimbal tilt.

- 
- ⚠ • Precision elements in the gimbal may be damaged by a collision or impact, which may cause the gimbal to function abnormally. Make sure to protect the gimbal from damage.
  - DO NOT add any extra payload to the gimbal as this may cause the gimbal to function abnormally or even lead to permanent motor damage.
  - Avoid getting dust or sand in the gimbal, especially in the gimbal motors.
  - A gimbal motor may enter protection mode in the following situations:
    - a. The aircraft is on uneven ground, and the gimbal is obstructed.
    - b. The gimbal experiences an excessive external force, such as during a collision.
  - Flying in heavy fog or clouds may make the gimbal wet, leading to temporary failure. The gimbal will recover full functionality once it is dry.
-

## Flight Control Surfaces

Not applicable for multicopters.

## Propulsion System

The propulsion system consists of motors, ESCs, and folding propellers, to provide stable and powerful thrust.

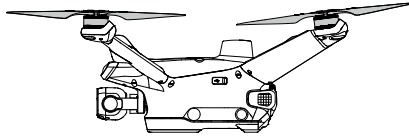

## Avionics

The avionics includes an aerial-electronics system, video transmission system, vision system and infrared sensing system, and DJI AirSense.

## Flight Control and Navigation System

The flight control and navigation system built into the aircraft has modules such as the flight controller, IMU, barometer, GNSS receiver, RTK module, and a compass, providing stable and reliable navigation and control. The dedicated industrial flight controller provides multiple operation modes for various applications. The GNSS+RTK dual-redundancy system is compatible with GPS, GLONASS, BeiDou, and Galileo. The aircraft also supports centimeter-level positioning when used with the built-in onboard RTK antennas.

## Aircraft RTK

When the aircraft is used with the RTK module of the dock, centimeter-level positioning data can be obtained, allowing for a precise flight route and landing.

Users can choose different positioning accuracy when making task plans in DJI FlightHub 2:

- RTK: The aircraft will take off and wait for the RTK data to converge before performing a task. It is unable to pause the task during convergence. It is recommended to choose this task when high positioning accuracy is required.
- GNSS: The aircraft will perform a task directly without converging RTK data. It is recommended to choose this task when basic positioning accuracy is acceptable. Make sure that there are no obstacles within 20 meters along the flight route before initiating the task plan.



- The number of searched satellites should be greater than 20 for the aircraft RTK data to converge. If there is strong signal interference or ionospheric scintillation, the aircraft RTK data may not converge.
  - The RTK positioning needs to be done in an environment with a strong GNSS signal (outdoors in an open area without obstacles) to ensure high-precision positioning. The RTK solution is fixed to converge to centimeter-level accuracy.
  - Make sure the dock RTK is calibrated before an RTK task to ensure accurate flight along the flight route.
  - If the aircraft RTK type is switched (for example switched to the network RTK using the remote controller then linked the aircraft and the dock), make sure to restart the aircraft before performing flight tasks.
- 

### Quick Takeoff

When the aircraft is used with the dock, quick takeoff can be achieved. The aircraft can quickly take off and perform flight tasks without waiting for the aircraft RTK data to converge. Quick Takeoff can be achieved in DJI FlightHub 2:

- Click Takeoff in the device status window after gaining aircraft control.
  - Select the positioning accuracy as GNSS in the Task Plan Library.
- 



- Quick Takeoff is only available when the dock has network connection and the network signal is strong.
- 

### Communications Equipment

The aircraft boasts DJI O3 Enterprise video transmission system with OcuSync video transmission antennas, offering stable and reliable communication with the control station.

### Vision System and Infrared Sensing System

The aircraft is equipped with an infrared sensing system and a vision system, allowing for vision positioning and six-direction obstacle sensing.

---



- To ensure a safe and steady flight, DO NOT block the vision and infrared sensors.
  - Clean the lenses of the vision and infrared sensing systems on a regular basis. If the vision sensor lenses are blurry, a warning will appear in DJI FlightHub 2 during flight tasks. Clean the lenses as soon as possible after the warning appears.
-

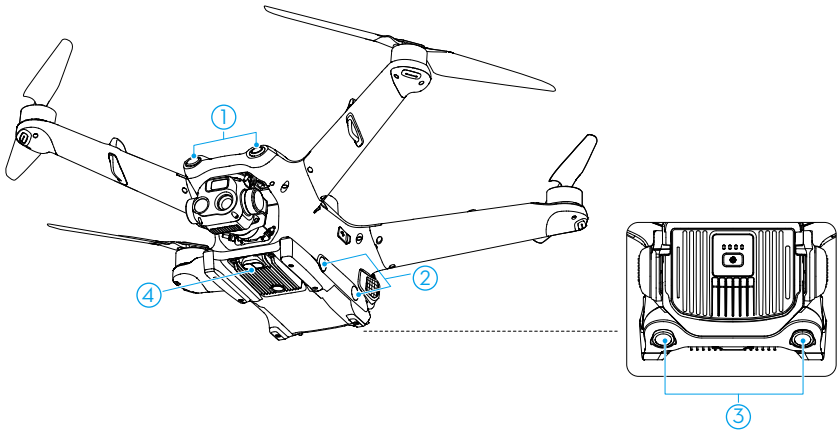

1. Forward and Upward Vision System
2. Lateral Vision System
3. Backward and Downward Vision System
4. Infrared Sensing System

## Detection Range

### Forward Vision System

Precision Measurement Range: 0.5-21 m; FOV: 90° (horizontal), 90° (vertical)

### Backward Vision System

Precision Measurement Range: 0.5-23 m; FOV: 90° (horizontal), 90° (vertical)

### Lateral Vision System

Precision Measurement Range: 0.5-15 m; FOV: 104° (horizontal), 90° (vertical)

### Upward Vision System

Precision Measurement Range: 0.5-21 m; FOV: 90° (front and back), 90° (left and right)

### Downward Vision System

Precision Measurement Range: 0.5-14 m; FOV: 95° (front and back), 110° (left and right) The downward vision system works best when the aircraft is at an altitude of 0.5 to 30 m.

### Infrared Sensing System

Precision Measurement Range: 0.1-8 m (>10% reflectivity); FOV: 60° (front and back), 60° (left and right)

## Vision System

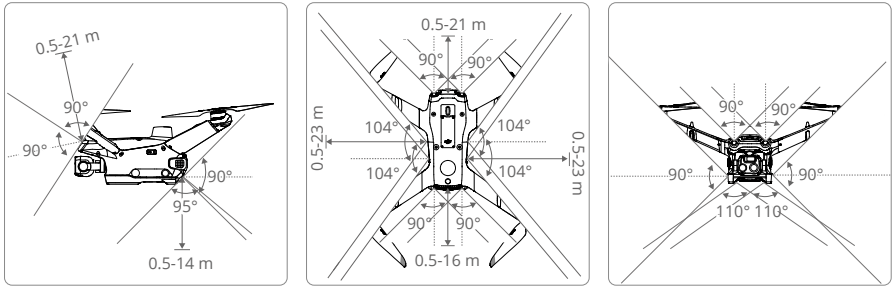

## Infrared Sensing System

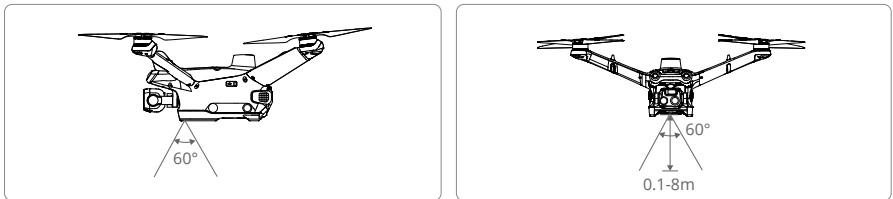

- ⚠️ • The aircraft has a 10° blind spot in the area to its upper rear, and cannot sense obstacles that are out of the detection range. Be aware of the blind spots. Always fly with caution.
- The aircraft cannot sense moving obstacles such as people, animals, or vehicles.

## Using the Vision System

The positioning function of the downward vision system is automatically enabled, and is applicable when GNSS signals are unavailable or weak. When flying in an environment where the aircraft is surrounded by obstacles, make sure the vision system is enabled for flight safety. The lateral and the upward vision system will activate automatically when the aircraft is powered on if the aircraft is in N mode and Obstacle Sensing is enabled in DJI FlightHub 2 or DJI Pilot 2. The lateral and the upward vision system work best with adequate lighting and clearly marked or textured obstacles.

- ⚠️ • Pay attention to the flight environment. The vision system and infrared sensing system only work in certain scenarios and cannot replace human control and judgment. During a flight, always pay attention to the surrounding environment and the warnings in DJI FlightHub 2. Be responsible for the aircraft at all times.
- The downward vision system works best when the aircraft is at an altitude from 0.5 to 30 m if GNSS is unavailable. Extra caution is required if the altitude of the aircraft is above 30 m as the vision positioning performance may be affected.



- The downward vision system may not work properly when the aircraft is flying near water. Therefore, the aircraft may not be able to actively avoid water below it when landing. It is recommended to make reasonable judgments based on the surrounding environment, and avoid over-relying on the downward vision system.
- The vision system cannot work properly near surfaces without clear pattern variations or where the light is too weak or too strong. The vision system cannot work properly in the following situations:
  - a. Flying near monochrome surfaces (e.g., pure black, white, red, or green).
  - b. Flying near highly reflective surfaces.
  - c. Flying near water or transparent surfaces.
  - d. Flying near moving surfaces or objects.
  - e. Flying in an area with frequent and drastic lighting changes.
  - f. Flying near extremely dark (< 10 lux) or bright (> 40,000 lux) surfaces.
  - g. Flying near surfaces that strongly reflect or absorb infrared waves (e.g., mirrors).
  - h. Flying near surfaces without clear patterns or textures.
  - i. Flying near surfaces with repeating identical patterns or textures (e.g., tiles with the same design).
  - j. Flying near obstacles with a small surface area (e.g., tree branches).
- Keep the sensors clean at all times. DO NOT scratch or tamper with the sensors. DO NOT use the aircraft in dusty or humid environments.
- DO NOT fly when it is rainy, smoggy, or the visibility is lower than 100 m.
- The infrared sensing systems may NOT detect the distance accurately in the following situations:
  - a. Flying near surfaces that can absorb sound waves (e.g., asphalt road surfaces).
  - b. Flying near a large area of strong reflectors situated at a distance of more than 15 m (e.g., multiple traffic signs placed side by side).
  - c. Flying near tiny obstacles (e.g., iron wires, cables, tree branches, or leaves).
  - d. Flying near mirrors or transparent objects (e.g., water or glass).
  - e. Flying in low-visibility environments (e.g., heavy fog or snow).
- DO NOT obstruct the vision cameras or the infrared sensors. DO NOT hang or place anything in an area that will block the vision system, infrared sensing system, and their observation range.
- Make sure that the sensor lens is clear and free of stains. DO NOT interfere with the vision system and infrared sensing system in any way such as using a strong light source to illuminate the vision system or aiming specular reflectors towards the infrared sensor.
- Check the following before placing the aircraft on the dock:
  - a. Make sure there are no stickers or any other obstructions over the glass of the infrared sensing system and the vision system.
  - b. Use a soft cloth if there is any dirt, dust, or water on the glass of the vision system and infrared sensing system. DO NOT use any cleaning product that contains alcohol.
  - c. Contact DJI Support if there is any damage to the lenses.

## Vision Detection for Propellers

After the dock initiates a flight task, the aircraft will perform vision detection for the propellers before taking off. The following conditions are required for propeller vision detection:

- DJI Matrice 3D Series propellers are used.
- In daytime when the lighting is sufficient.
- No vision system warnings in DJI FlightHub 2.
- The aircraft is about to take off before a flight route task.
- The propellers are clean.



- There are limitations of the vision detection function for the propellers. DO NOT completely rely on the vision system functions.
  - When a propeller error warning appears in DJI FlightHub 2, check whether the propellers are clean and not damaged. Clean the propellers if there is any noticeable build-up or replace damaged propellers and then restart the aircraft before performing a flight task.
- 

## DJI AirSense

Crewed airplanes or helicopters with Automatic Dependent Surveillance–Broadcast (ADS-B) transmitters can broadcast flight information. The DJI aircraft equipped with DJI AirSense can receive the flight information broadcast from ADS-B transmitters that comply with the 1090ES (RTCA DO-260) or UAT (RTCA DO-282) standard and within a radius range of 10 km. DJI AirSense only issues warning messages under certain circumstances when specific crewed airplanes or helicopters are approaching and are not able to actively control or take over the DJI aircraft to avoid collisions. Users should always fly the aircraft within the visual line of sight and be cautious at all times to ensure flight safety. DJI AirSense has the following limitations:

1. DJI AirSense can only receive messages broadcast by crewed airplanes or helicopters installed with an ADS-B Out device that is in compliance with the 1090ES or UAT standard. DJI AirSense cannot receive messages from crewed airplanes or helicopters that are not equipped with ADS-B Out devices or equipped with devices that are not functioning properly.
2. DJI AirSense uses satellite and radio signals to receive ADS-B messages. If there is an obstacle between a crewed airplane or helicopter and a DJI aircraft, DJI AirSense may not be able to receive broadcast and issue warning messages.
3. Warning messages may be sent with a delay if DJI AirSense experiences any interference from the surrounding environment. Users need to observe the surrounding environment and fly with caution.
4. Warning messages may not be accurate when the DJI aircraft is unable to obtain its location information.
5. DJI AirSense cannot receive broadcast from crewed airplanes or helicopters, nor send warning messages to DJI FlightHub 2 users when DJI AirSense is disabled or not properly functioning.

DJI FlightHub 2 collects all the DJI AirSense data reported by the dock aircraft in the project and displays the location of an approaching crewed airplane or helicopter, as well as a warning

message on the web page when there is a potential risk of collision. DJI AirSense can obtain and analyze the location, altitude, orientation, and velocity of the crewed airplane or helicopter and compare the information with the current location, altitude, orientation, and velocity of the dock aircraft to evaluate the collision risk in real time.

- Warning (high collision risk): A red airplane icon will appear on the map, and the web page will display the message stating, "Crewed aircraft nearby. Take over aircraft promptly to avoid". DJI FlightHub 2 users can click the dock name to open the device status window and obtain control of the aircraft to avoid collisions.
- Caution (medium collision risk): A yellow airplane icon will appear on the map when a crewed airplane or helicopter is relatively near the dock aircraft.
- Normal (low collision risk): A blue airplane icon will appear on the map when the crewed airplane or helicopter is relatively far away from the dock aircraft.



- Users can click  in the lower right corner of the map to decide whether to display the low and medium collision risk warnings on the map.
-



## Intelligent Flight Battery

### Battery Function

1. **Battery Level Display:** The battery level LEDs display the current battery level.
2. **Auto-Discharging Function:** To prevent swelling, the battery automatically discharges to 96% of the battery level when it is idle for three days, and automatically discharges to 60% of the battery level when it is idle for nine days. It is normal to feel moderate heat being emitted from the battery during the discharging process.
3. **Balanced Charging:** During charging, the voltages of the battery cells are automatically balanced.
4. **Overcharge Protection:** The battery stops charging automatically once fully charged.
5. **Temperature Detection:** To prevent damage, the battery only charges when the temperature is between 5° and 45° C (41° and 113° F).
6. **Overcurrent Protection:** The battery stops charging if an excess current is detected.
7. **Over-Discharge Protection:** To ensure flight safety and allow users to have as much time as possible to deal with emergencies during flight, over-discharge protection is disabled to allow continuous output. The aircraft will intelligently determine whether to perform RTH or to land based on the current flight battery level. Charging an over-discharged battery may cause a fire hazard. To prevent this, the battery will be locked and can no longer be charged or used.
8. **Short Circuit Protection:** The power supply is automatically cut if a short circuit is detected.
9. **Battery Cell Damage Protection:** A warning prompt will be displayed when a damaged battery cell is detected.
10. **Hibernation Mode:** The battery will be in Hibernation mode when not inserted to the aircraft to save power.
11. **Communication:** Information about the voltage, capacity, and temperature of the battery is transmitted to the aircraft.
12. **Warming Up:** The feature ensures the battery operates normally at a low temperature. Refer to the Warming the Battery section for more information.
13. **Water-resistant and Dust-resistant:** After being installed in the aircraft, the battery meets the IP54 rating standards.



- Refer to the user manual, safety guidelines, and battery labels before use. Users shall take full responsibility for all operations and usage.
  - Use batteries provided by DJI. DO NOT use other batteries.
  - DO NOT drop or damage the battery. DO NOT place heavy objects on the battery.
  - Always use a clean, dry cloth when cleaning the battery terminals. Otherwise, this may cause poor contact, resulting in energy loss or failure to charge.
  - The firmware for the Intelligent Flight Battery is included in the aircraft firmware. Make sure the firmware of all Intelligent Flight Batteries is updated to the latest firmware version.
-

## Using the Battery

### Installing and Removing the Battery

Open the battery locking arm and insert the Intelligent Flight Battery into the battery compartment of the aircraft until a click is heard. Close the battery locking arm until the orange mark completely disappears, which indicates the battery locking arm is in the lock position.

To remove the battery, open the battery locking arms, then press the battery buckles and remove the battery.

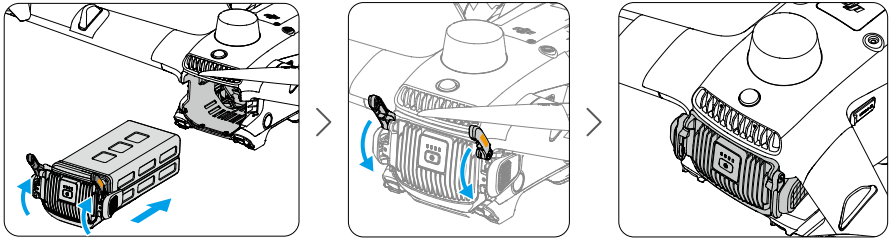

### Checking Battery Level

Using DJI FlightHub 2

There are two ways to check the battery information in DJI FlightHub 2.



1. Open the Project page, click > to view the battery level and battery status.
2. Open the Devices page, click Dock > to view the battery level and battery temperature, battery cycles and other information.



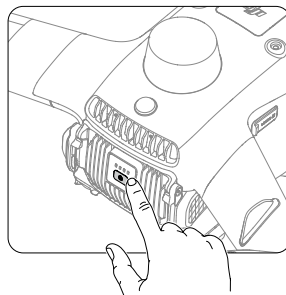





























### Using the Power Button

Press the power button once to check the battery level.



The battery level LEDs display the power level of the battery during charging and discharging. The statuses of the LEDs are defined below:

-  LED is on.
-  LED is blinking.
-  LED is off.

LED1	LED2	LED3	LED4	Battery Level
				89-100%
				76-88%
				64-75%
				51-63%
				39-50%
				26-38%
				14-25%
				1-13%

### Warming the Battery

#### Battery Self-Heating

The battery has a self-heating feature when operating in low-temperature conditions:

- When the battery temperature is lower than 18° C (64.4° F), self-heating starts once the battery is inserted into the aircraft and powered on. Self-heating will turn off automatically after takeoff. The aircraft cannot takeoff when the battery temperature is lower than 10° C (50° F). Flight tasks will start after the battery is warmed up.
- If the battery is not inserted into the aircraft, press and hold the power button for five seconds to initiate self-heating. The battery will continue to keep warm with a temperature between 15° to 20° C (59° to 68° F) for approximately 30 minutes. Press and hold the power button for five seconds to stop self-heating.
- When the battery is warming up and keeping warm, the battery level LEDs will blink as follows.

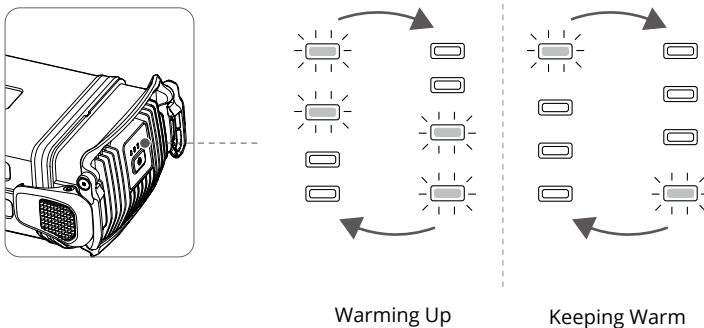

### Dock Warming

If the aircraft is powered off in low-temperature environments, the dock will constantly provide a power supply for the battery to keep warm, so that the aircraft can take off at any time in cold environments. After the battery charging is completed, if the aircraft is in the idle status, the battery will keep warm at a temperature above 10° C (50° F).

The battery will stop keeping itself warm when the user initiates an Immediate flight task, powers on the aircraft, or starts battery charging.

## Control Station

### Profile

The dock together with DJI FlightHub 2 is used as a control station to perform automated operations remotely. And the DJI RC Pro Enterprise remote controller (sold separately) can also be used for on-site control, if necessary.

### Dock

### Overview

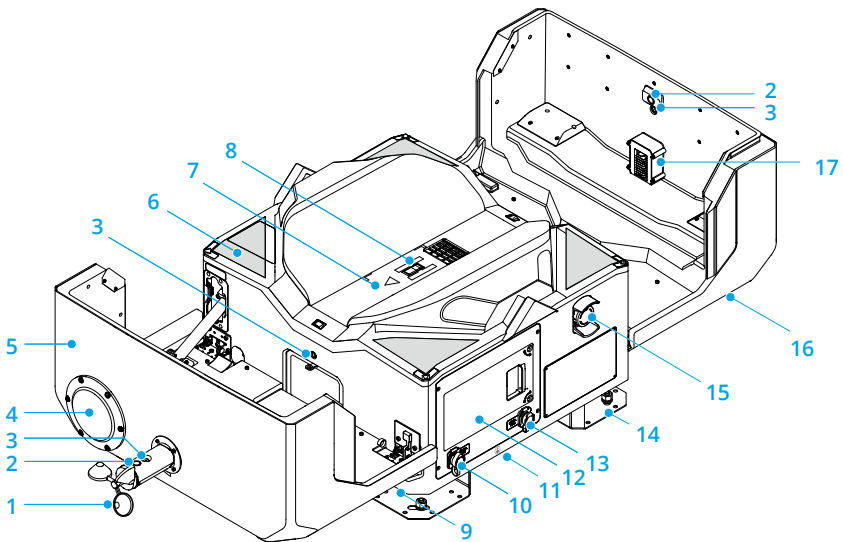

- |                           |   |                            |
|---------------------------|---|----------------------------|
| 1. Wind Speed Gauge       | 7. Landing Pad                                | 12. Electrical Cabinet     |
| 2. Security Camera        | 8. Aircraft Orientation Marker <sup>[1]</sup> | 13. LAN-IN Port            |
| 3. Camera Auxiliary Light | 9. Carrying Points                            | 14. Mounting Base Brackets |
| 4. Rainfall Gauge         | 10. AC-IN Port                                | 15. Emergency Stop Button  |
| 5. Dock Cover             | 11. Earth Wire (located underneath the dock)  | 16. Status Indicators      |
| 6. Positioning Markers    |   | 17. Dongle Compartment     |

[1] The dock is equipped with a built-in charging module. Make sure the surface is clear of any metal objects in order to avoid high temperatures that may damage the landing pad. Make sure the aircraft orientation is consistent with the arrow on the landing pad.

## Electrical Cabinet

The Electrical Cabinet has an AC Power Switch, Backup Battery Switch, Surge Protective Device (SPD), and multiple USB ports. The electrical cabinet can be used to connect the power supply, wired network connection, and external cables for dock grounding. The dock can be connected to the remote controller via the USB-A port in the electrical cabinet or to a computer via the USB-C port.

Use a 2.5mm hex key to loosen the two screws on the electrical cabinet door. Pull the door to open and view the operation panel.

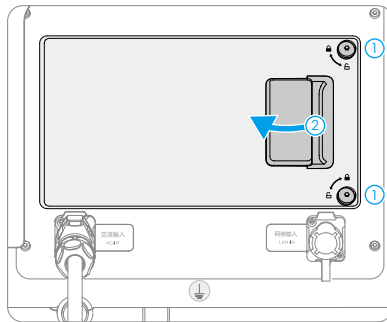



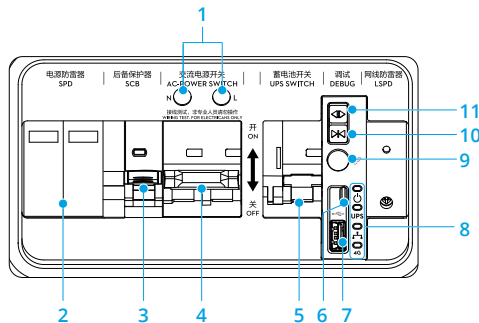





## Panel Description



Overview	Description
1. Wire Testing Terminals	Connect to a multimeter to test the voltage when configuring the dock.
2. SPD for AC Power	Protects electrical devices of the dock from lightning, overvoltage, and surge damage.
3. Surge Protector Circuit Breaker (SCB)	Protects the SPD for AC Power to avoid risk of fire.

4. AC Power Switch	Power on/off the dock.
5. Backup Battery Switch	Enable/Disable backup battery of the dock.
6. USB-C Port	Connect to a computer to access DJI Assistant 2.
7. USB-A Port	Connect the remote controller to the dock for dock configuration and set up.
8. Electrical Cabinet Indicators	Indicate the working status of the AC power supply, backup battery, wired network connection, and 4G network.
9. Link Button	Press and hold the link button to link the dock and the aircraft.
10. Close Button	Press and hold the close button to close the dock cover.
11. Open Button	Press and hold the open button to open the dock cover.

### Electrical Cabinet Indicators

Status Indicator	Status	Description
 Power Indicator	 — Solid red Off	AC power supply is normal. No AC power supply.
	 — Solid blue  ..... Blinks blue slowly  ..... Blinks blue quickly Off	Backup battery is full or is supplying power to the dock. Backup battery is charging. Backup battery has low battery power. Backup battery is not installed or the backup battery switch is turned off.
 Wired Network Indicator	 ..... Blinks green quickly Off	The Ethernet cable is connected and has data transfer with the dock. The Ethernet cable is disconnected.
	 ..... Blinks green quickly Off	4G network is connected and has data transfer with the dock. 4G network is disconnected or does not have data transfer with the dock.

## Backup Battery

The dock features a backup battery with a capacity of 12 Ah and a maximum runtime of more than five hours. If the dock is powered off due to an emergency power outage, the backup battery can provide power to the dock so that the aircraft can safely return to the dock and land.

- ⚠ After a power outage, the dock does not support functions such as aircraft charging, air conditioning, and heating of the dock cover and wind speed gauge. Always check any malfunctions in time.
- Check and fix the malfunctions as soon as possible to restore power to the dock. Make sure to turn off the backup battery switch if the power supply cannot be restored and the dock is not used for an extended period of time. Otherwise, the backup battery will be over-discharged. Replace the backup battery if over-discharged.

## Charging the Backup Battery

If the dock is stored for an extended period of time, make sure to charge the backup battery before use:

1. Use a 2.5mm hex key to loosen the two screws on the electrical cabinet door. Pull the door to open.
2. Turn on the AC power switch (A) to power on the dock. Turn on the backup battery switch (B) to charge the backup battery.

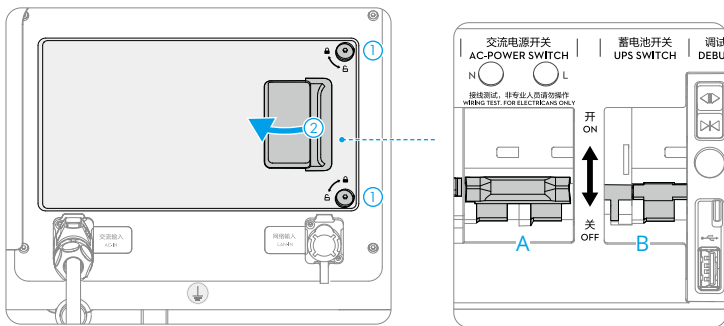

When the dock is not in use for an extended period of time, make sure to maintain the backup battery by charging it for at least six hours. Refer to the following table for the backup battery maintenance intervals under different storage environment temperatures.



Storage Environment Temperature	Backup Battery Maintenance Interval
Below 20° C (68° F)	Every nine months
20° to 30° C (68° to 86° F)	Every six months
30° to 40° C (86° to 104° F)	Every three months
40° to 60° C (104° to 113° F)	Every month

- ⚠ • If the dock has no AC power supply, refer to the Installation and Setup Manual to connect the power cable and power on the dock before charging the backup battery. Only certified electricians can carry out the above-safety-voltage operations. Pay attention to safety during operation in order to avoid an electric shock. Make sure the cables are correctly connected to the PE, N, and L terminals.
- The backup battery cannot be charged when the battery temperature is higher than 40° C (104° F) or lower than -25° C (-13° F).

## Dock Cover

The internal video transmission antennas and status indicators are located on the dock cover. The Dock Cover Propeller Bumpers on the dock cover are used for folding the aircraft propellers when closing the dock cover. The heating strips on the dock cover seam can automatically heat the dock cover to prevent the seam from freezing.

- ⚠ • Make sure the internal video transmission antennas are not blocked by snow, ice, or any foreign matter.
- The dock cover heating strips can only prevent the dock cover seam from freezing. Make sure to clean any snow or ice on the dock cover.
- Regularly check if the propeller bumpers are in good condition. Replace any worn or damaged parts when necessary.

## Opening and Closing the Dock Cover



When performing remote debugging, the dock cover can be opened or closed using DJI FlightHub 2 or DJI Pilot 2 to check the aircraft status and the component status inside the dock. The dock cover can also be controlled using either the open or close button in the electrical cabinet. Make sure the emergency stop button is released before opening the dock cover. If the emergency stop button is not released, pull out or rotate clockwise to release the emergency stop button.

- ⚠ • Keep a safe distance from the dock cover to avoid injury when opening or closing the dock cover. Press the emergency stop button if necessary.
- DO NOT press or place heavy objects on the dock cover after it is opened.

## Using DJI FlightHub 2

Open the DJI FlightHub 2 Project page, click  >  > Action, and enable Remote Debugging; or open the Devices page, click Dock >  > Device Maintenance, and enable Remote Debugging to open or close the dock cover.

If the dock cannot detect the aircraft, check whether the aircraft is on the landing pad by using the dock livestream, and follow the instructions in DJI FlightHub 2. Click Force Close Dock Cover if the aircraft is not on the landing pad. Click Close Dock Cover if the aircraft is on the landing pad.

- 
-  • When closing the dock cover, the aircraft will automatically power on, and the propellers will slowly rotate to avoid damage to the propellers.
  - When the aircraft battery level is low, the aircraft cannot power on to rotate and fold the propellers and the dock cover cannot be closed remotely. To avoid this situation, the dock will automatically close the dock cover when the battery level is below 6%, and the aircraft will automatically power off when the battery level is below 3%.
- 
-  • If the dock has no power supply, the aircraft cannot power on to rotate and fold the propellers before closing the dock cover. In this case, DO NOT remotely open the dock cover in DJI FlightHub 2. Otherwise, the dock cover cannot be closed.
  - DO NOT click Force Close Dock Cover if the aircraft is on the landing pad. Otherwise, the propellers and the dock cover may be damaged.
- 

## Using DJI Pilot 2

Connect the remote controller to the dock. Run DJI Pilot 2 and tap Open Dock Cover.

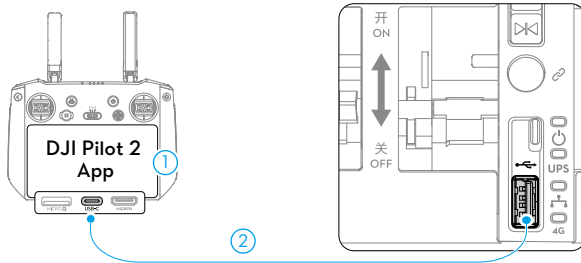

### Using the Open or Close Button



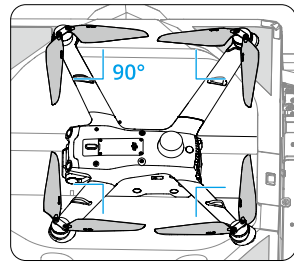
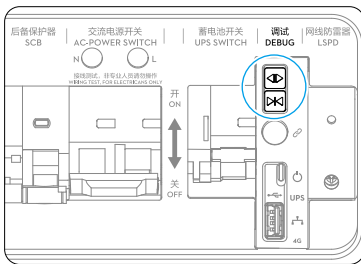

1. Make sure the dock is powered on, and the dock cover status indicators are blinking.
2. Use a 2.5mm hex key to loosen the two screws on the electrical cabinet door. Pull the door to open.
3. Press and hold the open or close button, and the dock cover will open or close.

-  • Make sure there are no obstacles blocking the dock cover. Keep your hands away from the dock cover to avoid injury.
- Before closing the dock cover, make sure to adjust the propeller position as shown in the diagram in order to avoid breaking the propellers when closing the dock cover.





### Dock Cover Status Indicator and Buzzer Alerts

#### Normal States

	Blinks white	The dock is working normally and the aircraft is ready to take off.
	Blinks blue	The dock and the aircraft are linking, and the buzzer emits a short beep.
	Blinks green	The aircraft has taken off from the dock and is performing a flight task.
	Solid blue	The dock is updating or debugging (including remote debugging and on-site debugging).

#### Warning States

	Blinks red	The dock cover is moving or the aircraft is taking off or landing, and the buzzer emits a long beep.  <b>Keep a safe distance from the dock to avoid injury.</b>
	Blinks red and yellow alternately	The emergency stop button on the dock is pressed.

## Environmental Monitoring System

The dock integrates multiple environment sensors to provide information on wind speed, rainfall, temperature, and humidity, allowing users to monitor the real-time environment conditions and ensure safe flight.

## Security Cameras and Camera Auxiliary Lights

The dock is equipped with two security cameras and three camera auxiliary lights for monitoring.

1. Security Camera: The integrated security camera is used to monitor the real-time dock environment. Users can remotely view the weather conditions, environmental circumstances, and the takeoff and landing conditions in the device status window in DJI FlightHub 2.
2. Camera Auxiliary Light: The auxiliary lights are automatically enabled at night or in low-light conditions to help the aircraft to identify the positioning markers.

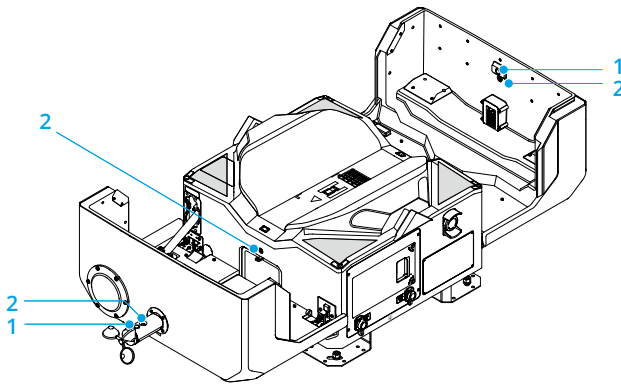

## Wind Speed Gauge

The wind speed gauge is used to measure wind speed near the dock. The wind speed gauge features self-heating and is able to work in low-temperature environments. Users can view real-time wind speed in DJI FlightHub 2. To ensure flight safety, the aircraft cannot take off or land when the wind speed is above 8 m/s.

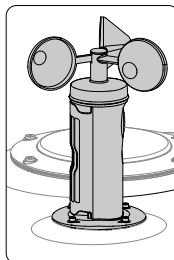

- 
- ⚠ • The wind speed gauge can only measure the wind speed near the dock, which may be different from the wind speed provided by the local meteorological department. If the aircraft ascends to a high altitude, the wind speed and direction may change significantly. Fly with caution when the measured wind speed is close to 8 m/s.
- 

## Rainfall Gauge

The rainfall gauge is used to measure rainfall information near the dock. The rainfall gauge features self-heating and is able to work in low-temperature environments. Users can view the rainfall information in DJI FlightHub 2. To ensure flight safety, the aircraft cannot take off in heavy rain.

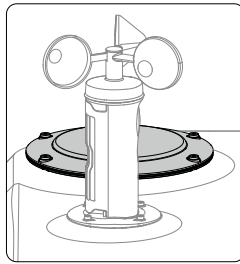

- 
- ⚠ • There is a pressure sensing module in the rainfall gauge. DO NOT press hard on the surface of the rainfall gauge. Otherwise, the pressure sensing module may be damaged.
- Regularly clean the rainfall gauge surface. Replace the rainfall gauge immediately if it is deformed or damaged.
  - If the dock is installed near a vibration source such as near railways, false detection of rainfall may be triggered. Try to keep the dock away from areas with strong vibration sources or strong noise.
-

## Temperature and Humidity Sensors

The dock features temperature and humidity sensors, which are used to measure external temperature and the temperature and humidity inside the dock. The temperature and humidity sensor inside the dock is shown in the diagram below.

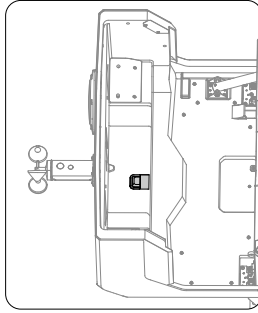

Open the Devices page, click Dock >  and enable Remote Debugging to view the temperature and humidity information.

To ensure flight safety, the aircraft cannot take off when the external temperature is below  $-20^{\circ}\text{C}$  ( $-4^{\circ}\text{F}$ ). Flight tasks will be resumed after the external temperature is higher than  $-20^{\circ}\text{C}$  ( $-4^{\circ}\text{F}$ ).

## Water Immersion Sensor

The dock features water immersion sensors, which can be used to detect whether the dock is immersed in water. If a water immersion warning appears in DJI FlightHub 2, contact a qualified electrician to disconnect the dock power supply and remove the water. If the dock works properly, resume the dock power supply. If the dock fails to work properly, make sure to turn off the AC power switch and backup battery switch, and contact DJI Support.

## Landing Pad

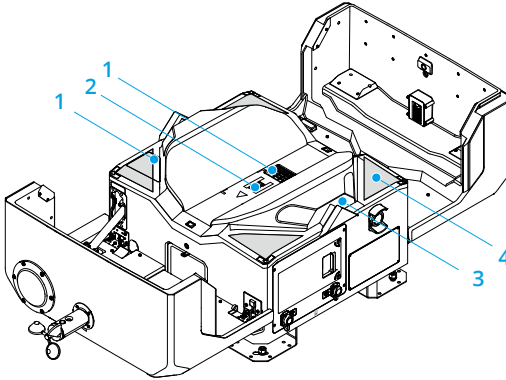

1. Return Vent and Supply Vent: Clean the return vent and the supply vent regularly to remove any dust or debris.
2. Aircraft Orientation Marker: When placing the aircraft on the landing pad, make sure to align the aircraft heading with the aircraft orientation marker. Otherwise, the aircraft may be damaged.
3. RTK module: Make sure the landing pad is clear of obstacles and that the internal RTK antennas are not covered. Otherwise, the signals will be obstructed and the positioning performance will be affected.
4. Positioning Markers: There are four positioning markers on the landing pad for the aircraft to identify the position of the dock.

- 
- ⚠** • After the dock is powered on, DO NOT place any metal objects such as rings or any electronic devices on the landing pad, or touch the landing pad surface when placing the aircraft on the landing pad to avoid burns.
- The dock cannot charge the aircraft battery if metal foreign objects are detected on the landing pad.
- 

## Air Conditioning System

The air conditioning system facilitates temperature adjustment inside the dock. When the dock is in Idle status, the air conditioning system will automatically adjust the temperature inside the dock, providing a suitable environment for the aircraft and the Intelligent Flight Battery.

After a flight task, the dock will start cooling when the ambient temperature exceeds 5° C (41° F) and the aircraft battery temperature exceeds 35° C (95° F). The dock will stop cooling when the aircraft battery temperature drops below 30° C (86° F). If the aircraft battery temperature cannot be detected, the temperature of the internal circulation supply vent will be used as reference.

Users can open the DJI FlightHub 2 Devices page, click Dock > , and enable Remote Debugging to start heating or cooling.

-  • To ensure the service life of the air conditioning system, a five-minute interval is required when switching between cooling and heating operations. A countdown will appear in DJI FlightHub 2. Wait for the countdown to end before switching operations.

## Dock Network Connection

The dock can be connected to a wired network or 4G network <sup>[1]</sup> for internet access. Users can choose different internet access based on actual needs. When the dock is connected to both a wired network and a 4G network, the wired network will be used first.

[1] 4G network service is not available in some countries or regions. Please consult your local DJI authorized service providers or DJI Support for more information.

## DJI FlightHub 2 (Information Display and User Interface)

DJI FlightHub 2 is a cloud-based aircraft task management platform, providing features such as member, device, map photos, task area, flight route, and task plan management. By planning flight routes on the web and distributing tasks to docks and supported aircraft, DJI FlightHub 2 makes remote access to real-time task information possible and improves team productivity and efficiency.

Note: The information on the webpage may vary in different versions.

## Cloud Management

### Organization and Project Management

Users can visit <https://fh.dji.com> to enter the DJI FlightHub 2 Organization page after logging in with a DJI account. DJI FlightHub 2 supports centralized management for Projects, Members, and Devices. Before first use, please refer to DJI FlightHub 2 User Guide, and follow the instructions to create an organization and a project, bind the dock and add members to a project, and assign permissions to members.

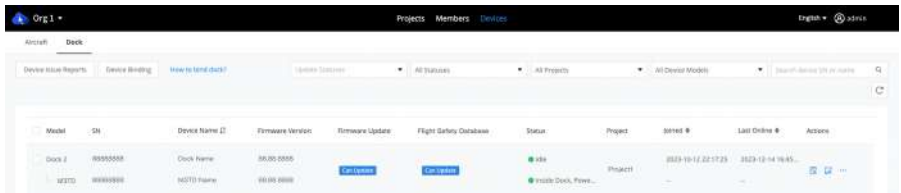









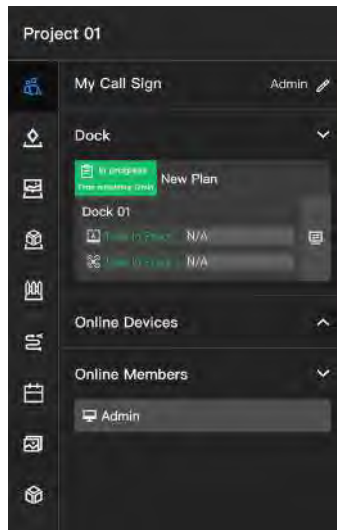



- Users can click the user account in the upper right corner, select User Center to view the account and organization information, and add a mobile number or email address for a service subscription. After the service is subscribed, the system will automatically send a message or email to notify users of an emergency or failed task.

## Project Details

In the Projects page, select a project and click  to enter the project. Users can plan flight routes, create task plans, manage models, and media files, as well as monitor real-time flight task information.



-  **Team:** Displays team, device, and flight task information of the project.
-  **Map Annotations:** Users can create and manage annotations (e.g. cell sites and other buildings) on the map.
-  **Map Photos:** Users can manage all the photos that are overlaid on the map.
-  **Map Models:** Users can view and manage the 2D and 3D models.
-  **Map Task Area:** The aircraft will plan the optimal path according to the task area data to perform FlyTo tasks and RTH, while bypassing obstacles and GEO zones.
  - Custom Flight Area: Users can manage custom task areas (user defined operation zones) and custom GEO Zones (user defined no-fly zones).
  - Obstacle Data: Users can enable obstacle data, and DJI FlightHub 2 will distribute the data to the dock aircraft.
  - Data Synchronization: When the flight areas are updated, the data will be automatically synchronized to the idle dock and aircraft.

-  **Flight Route Library:** Users can import or create flight routes, as well as edit flight route settings and waypoint actions in Flight Route Library. Users can also enter the FPV view to edit waypoints to achieve more accurate flight route planning.
-  **Task Plan Library:** Users can designate flight routes and devices, and create task plans in Task Plan Library based on their actual needs. The aircraft will take off automatically according to the preset Plan Timer. Resume Flight from Breakpoint can be enabled when creating a task plan or can be enabled in the task plan library. In case of low temperatures, strong winds, or long flight routes, the flight task cannot be completed in a single flight. In this case, if Resume Task from Breakpoint is enabled (or triggered), a new task will be automatically generated, and the aircraft will resume the flight from the breakpoint and complete the task after the battery charging is completed.
-  **Media Files:** Users can view and manage the uploaded media files. The media files (images and videos) can be automatically uploaded to the dock after each flight task. The aircraft will automatically delete the file after it is uploaded to the dock. The dock will upload the received media files to DJI FlightHub 2. The dock will automatically delete the file after it is uploaded to DJI FlightHub 2.
-  **Model Library:** Users can import and view 2D and 3D models. Model Library supports displaying the model on the Map, which can be further used to create flight routes.

 • For more details, refer to the DJI FlightHub 2 User Guide which is available on <https://fh.dji.com/user-manual/en/overview.html>.

## Real-Time Device Information

When the dock is performing a flight task, DJI FlightHub 2 will display the real-time device information, including the task status, flight route (green), aircraft trajectory (blue), and livestreams.

## Device Status Window

Select a device and click  to open the device status window. Users can view the flight task status, device operation status, and device information in the device status window.



1. **Flight Task Status:** Indicates the flight task status of the selected dock. Flight task status includes task plan status and live flight controls status. Click to view all flight tasks of the dock on that day.
2. **Pause/RTH:** Click to pause the flight task or trigger RTH. The flight task can be resumed.
3. **Dock Information:** Users can view the dock flight task status, dock status, wind speed, ambient temperature, rainfall, internet speed, and media file upload status.  
If a warning message appears during flight, it will be displayed in the system status bar. Tap to view the message. Warnings that are not reported in real-time will not be displayed.
4. **Live:** Click to view the dock livestream. Users can switch between camera views to check inside or outside the dock.
5. **Actions:** Click to view more information about the dock and the aircraft, change aircraft settings and perform remote debugging.

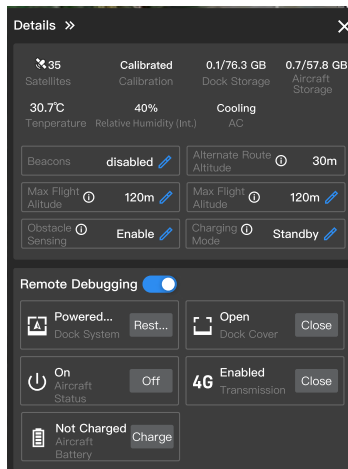

- 
- The dock and aircraft can only be remotely operated by one user at a time.
  - After Remote Debugging is enabled, yellow and black strips will appear around the dock and aircraft in the device status window. Users can hover the mouse over the dock image to view the operator account.
- 

6. **Aircraft Information:** Users can view the aircraft flight task status, device warnings, transmission signal strength, satellite connection status, battery status, and aircraft altitude. When the aircraft is disconnected from the dock, the last recorded time and coordinates of the aircraft will be displayed. Users can click the information to center the aircraft location at the middle of the map and then right-click to create a PinPoint to help locate the aircraft during a search. The information will not be displayed after the aircraft re-connects to the dock.
7. **Aircraft Control:** Project administrators can remotely operate the aircraft after clicking Aircraft Control. Go to the DJI FlightHub 2 User Guide and refer to the [Live Flight Controls](#) section for more information.

- 8. **Aircraft Livestream:** Click to view the aircraft livestream. Users can click the camera type to switch between different camera views. Click  to start recording during a livestream, and the recorded video will be stored to Media Files automatically.





- 9. **Share:** Click to share the livestream view to other users and customize the sharing settings.

## Device Management

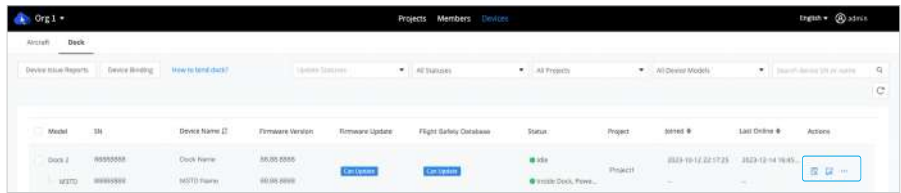
In the Devices page, click Dock to switch to Dock Management. Administrators can view the device warning messages and perform remote debugging.



-  : Click to view warning details of the dock and aircraft. The warning messages include the start and end time, warning level, device type, error code, content, and recommended solutions.
-  : Click to open the Device Maintenance page, users can view device details and perform remote debugging.
-  : Click and select Edit to bind the dock to a specific project. Select Delete to remove the device from this organization. Exercise Delete with caution.

---

 • If the dock information is deleted, connect the remote controller to set up the dock and rebind the dock to an organization. Exercise Delete with caution.

---

 • Users can update the device firmware and the flight safety database in the Devices page.

---

## Device Maintenance

### Device Information

Users can view device information and modify aircraft settings in the Device Maintenance page.



- Dock Information:** Users can view the dock name, type, firmware version, SN, maintenance program, DJI Care Enterprise, and other status information on the dock status panel.
- Dock Environment Information:** Users can view the dock temperature, rainfall, real-time wind speed, and other environmental information.

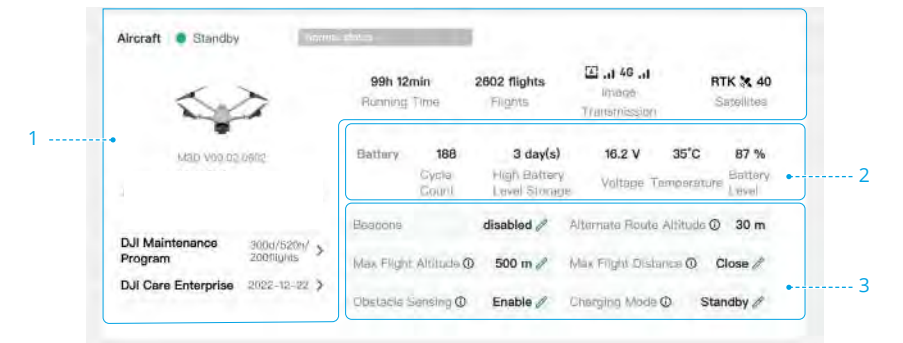

- Aircraft Information:** Users can view the aircraft name, type, firmware version, SN, maintenance program, DJI Care Enterprise, and other aircraft information.
- Battery Information:** Users can view the battery cycles, battery voltage, battery temperature, and battery level.

- 3. Aircraft Settings: Users can modify the beacon status, alternate route altitude, maximum flight altitude and distance, obstacle sensing status, and charging mode. Click ⓘ to view the detailed descriptions for the settings.

⚠ • After disabling obstacle sensing, the aircraft cannot detect or bypass obstacles and may cause the aircraft to crash.

### Remote Debugging

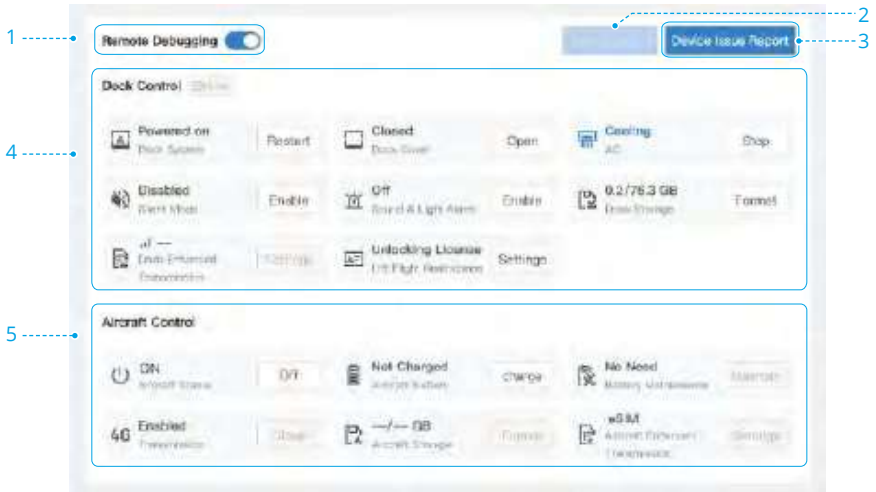

- 1. Remote Debugging: Users can enable Remote Debugging to control the dock and the aircraft if any device issue occurs.
- 2. Trial Flight: Users can quickly test the task performance and the media file transfer performance for the dock. Click Trial Flight and confirm the settings of the created task plan. During the trial flight, the aircraft will ascend 60 m vertically, the gimbal will tilt down to 90° to take a photo, and the aircraft will then return home.
- 3. Device Issue Report: Users can submit an issue report to report issues that occurred to the dock or aircraft. After submitting, please wait for feedback from DJI Support. Refer to the Device Issue Report section for more information.
- 4. Dock Control:
  - a. Users can restart the dock system and control the dock cover, and air conditioning system. Users can also enable the sound-light alarm and silent mode, format the dock storage, customize the enhanced transmission settings, and set the unlocking license details.
  - b. Click Live to view the dock livestream.
- 5. Aircraft Control:
  - a. Users can power on/off the aircraft, charge the Intelligent Flight Battery, and format aircraft storage.

- b. Battery Management: Click Charge to charge the Intelligent Flight Battery.
- c. Click Camera to view the aircraft livestream.

- ⚠ • The Trial Flight feature requires the dock firmware to be v09.02.0108 or above.
- Remote debugging cannot be enabled if the dock is connected to the remote controller for on-site operations.
- The aircraft cannot take off after enabling remote debugging.
- When the aircraft battery level is too low, wait for the battery to charge in order to close the dock cover after enabling remote debugging.

- 💡 • When silent mode is enabled, the operating noise of the dock will be reduced. Note that the following will occur:
  - a. The fan noise will be reduced and the cooling performance of the air conditioning system will be affected. The task interval may be longer in high temperatures.
  - b. The buzzer sound of the dock will be disabled. Stay away from dock when opening or closing the dock cover.
  - c. The white lights indicating the idle status of dock will be turned off. Other status indicators are not affected.

## Device Issue Report

If the device issue cannot be addressed via Remote Debugging, users can create device issue reports in the Device Maintenance page and provide the report information to DJI Support.

1. In the Device Maintenance page, click Device Issue Reports > Create Report.

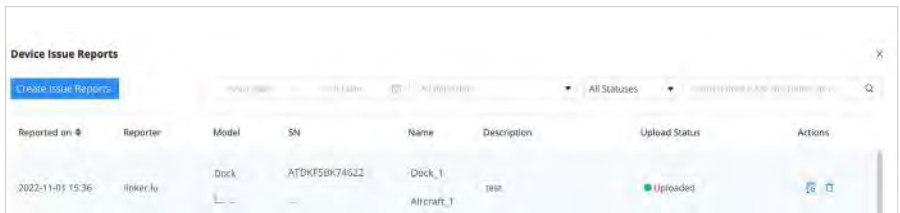

2. Fill in Report Details such as issue description, issue occurrence time, and contact information, and uploading screenshots or a video recording of the issue.
3. Upload device logs using one of the following methods:
  - a. Click the checkbox to select designated device logs.
  - b. Enable Synchronize Selection. DJI FlightHub 2 automatically selects device logs that coincide within the issue occurrence time range.
4. Click Submit to finish the issue report.
5. Click to check the report. After submitting, please wait for feedback from DJI Support.

- ☀️ • Select and upload the device logs within the issue occurrence time range to reduce the log upload time.
- Click Devices > Dock > Device Issue Reports to check all issue reports under the current organization.
- Make sure to power on the aircraft before uploading the aircraft logs. If the aircraft is powered off, check if the aircraft is inside the dock, wait for the aircraft to automatically power on, and click the refresh button to reload the aircraft logs.
- Make sure to submit the issue report in time to avoid the device logs being overwritten and failure to identify the problem.
- Users can also connect a computer to the dock and export device logs via DJI Assistant 2 (Enterprise Series), and then upload the device logs in Device Issue Report.

## Remote Controller (Sold Separately)

DJI RC Pro Enterprise remote controller (sold separately) can be used for configuring the dock, and can be linked to the aircraft as controller B. During on-site flight tests, the remote controller can take over control and manually control flight.

### Overview

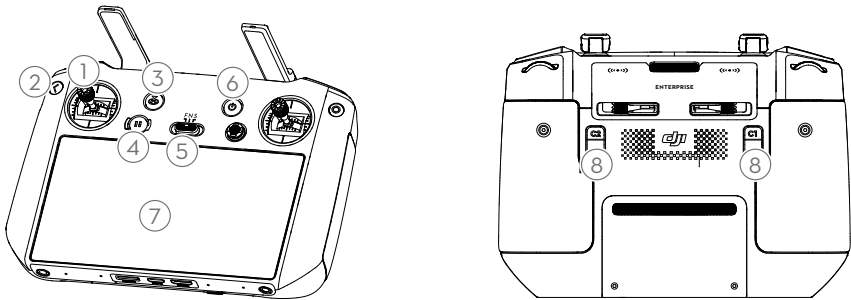

1. **Control Sticks:** Control the aircraft movement after gaining the aircraft control on the remote controller. Flight control mode can be set in Camera View > ... > .
2. **Back/Function Button:** Press once to return to the previous screen. Press twice to return to the home screen.
3. **RTH Button:** Press and hold the button until the remote controller beeps to start RTH. The aircraft will fly to the last updated Home Point. Press again to cancel RTH.
4. **Flight Pause Button:** Press once to make the aircraft brake and hover in place (only when GNSS or vision system is available).
5. **Flight Mode Switch:** Flight modes include N-mode (Normal), S-mode (Sport), and F-mode (Function). F-mode can be set to A-mode (Attitude) or T-mode (Tripod) in DJI Pilot 2. DJI Matrice 3D series aircraft flies in N-mode (Normal) by default.
6. **Power Button:** Press once to check the current battery level. Press, then press and hold to power the remote controller on or off. When the remote controller is powered on, press once to turn the touchscreen on or off.



- 7. Touchscreen:** Touch the screen to operate the remote controller. Note that the touchscreen is not waterproof. Operate with caution.
- 8. Customizable C1/C2 Buttons:** C1 button is used to switch the wide-angle camera and zoom camera view by default. C2 button is used to switch the map and camera view by default. Run DJI Pilot 2 and enter camera view. Tap **••• >**  to configure the functions of these buttons.

## Preparing the Remote Controller

### Charging

Charge the remote controller to activate the internal battery before first time use.

The remote controller cannot be powered on before activating the internal battery.

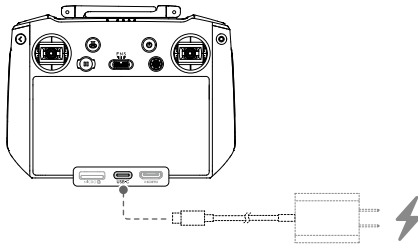

- Users can also charge the remote controller using the DJI USB-C Power Adapter (100W) included in the DJI Matrice 3D Series Charging Kit (sold separately).



- Fully discharge and charge the remote controller every three months. The battery depletes when stored for an extended period of time.
-

### Installation

1. Remove the control sticks from the storage slots and mount them on the remote controller.
2. Unfold the antennas.



### Activation

The remote controller needs to be activated before first use and an internet connection is required for activation. Press, then press and hold the power button to power on the remote controller. Follow the on-screen prompts to activate the remote controller.

### Using the Remote Controller

#### Powering On/Off

Press the power button once to check the current battery level.

Press, then press and hold the power button for two seconds to power the remote controller on or off.

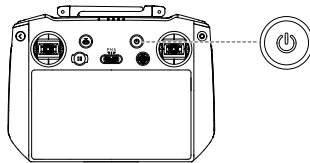



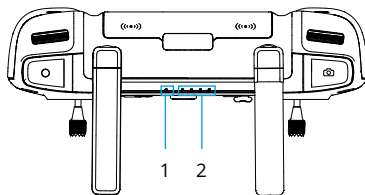



#### Remote Controller LEDs and Alerts



















1. Status LED
2. Battery Level LEDs

## Status LED

Blinking Pattern	Description
 — Solid Red	Aircraft disconnected
 ..... Blinks red	The temperature of the remote controller is too high, or the battery level of the aircraft is low
 — Solid green	Connected with the aircraft
 ..... Blinks blue	The remote controller is linking to an aircraft
 — Solid yellow	Firmware update failed
 ..... Blinks yellow	The battery level of the remote controller is low
 ..... Blinks cyan	Control sticks not centered

## Battery Level LEDs

Blinking Pattern				Battery Level
				76%-100%
				51%-75%
				26%-50%
				0%-25%

## Remote Controller Alert

The remote controller vibrates or beeps twice continuously to indicate an error or warning. Pay attention to the prompts that appear on the touchscreen or in DJI Pilot 2. Slide down from the top of the screen and tap  to mute. Note: After muting, all sounds of the remote controller will be completely disabled, including related alarm sounds. Please use the mute function with caution.

## Optimal Transmission Zone

The signal between the aircraft and the remote controller is most reliable when the antennas are positioned in relation to the aircraft as illustrated below.

The optimal transmission range is where the antennas are facing the aircraft, with the angle between the antennas and the back of the remote controller being 180° or 270°.

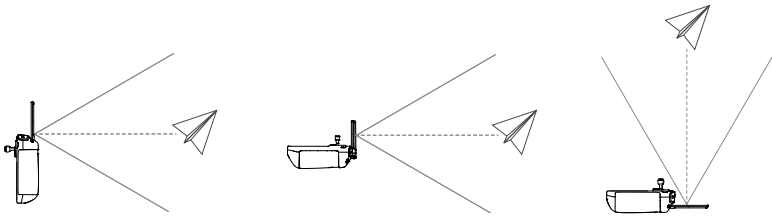

## Command and Control Link (C2 Link)

The command and control (C2) link between the aircraft and control station is established using DJI O3 Enterprise video transmission technology with the OcuSync video transmission antennas and DJI O3 Enterprise video transmission system, offering stable and reliable communication. The C2 link provides the control signal from the control station to the aircraft, facilitating real-time operations. Its performance can be viewed from Supplements > Specifications > Video Transmission.

## Ground Operational Area Setup

The aircraft will take off from and land at the dock. It is recommended to install a protective fence so that unauthorized personnel cannot enter the area where the dock is installed. Refer to the Installation and Setup Manual for more information on the protective fence.

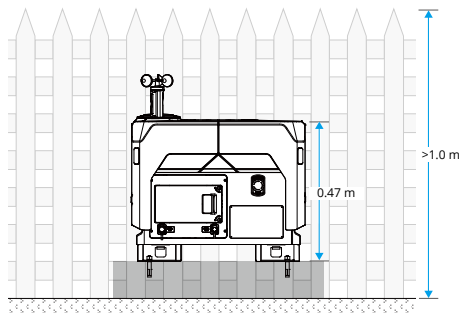
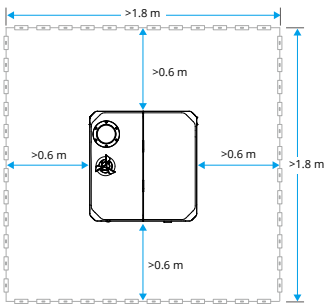

# Performance and Limitations

---

# Performance and Limitations

## Performance

Refer to Supplements > Specifications > Aircraft, and then General for more information on the detailed flight performance of the aircraft.

## Prohibited Actions

The following actions are prohibited:

- DO NOT operate in the vicinity of crewed aircraft. DO NOT interfere with the operations of crewed aircraft. Be alert and make sure there is no other aircraft in the operation area.
- DO NOT fly the aircraft in venues of major events, including but not limited to sporting events and concerts.
- DO NOT fly the aircraft without authorization in areas prohibited by local laws. Prohibited areas include airports, national borders, major cities and densely populated areas, venues of major events, areas where emergencies have occurred (such as forest fires), and locations with sensitive structures (such as nuclear power plants, power stations, hydropower plants, correctional facilities, heavily traveled roads, government facilities, and military zones).
- DO NOT fly the aircraft above the authorized altitude. DO NOT use the aircraft to carry illegal or dangerous goods or payloads.
- Make sure you understand the nature of your flight operation (such as for recreation, public, or commercial use) and have obtained corresponding approval and clearance from the related government agencies before flight. Consult with your local regulators for comprehensive definitions and specific requirements. Note that remotely-controlled aircraft may be banned from conducting commercial activities in certain countries and regions. Check and follow all local laws and ordinances before flying, as those rules may differ from those stated here.
- Respect the privacy of others when using the camera. DO NOT conduct surveillance operations, such as image capture or video recording on any person, entity, event, performance, exhibition, or property without authorization or where there is an expectation of privacy, even if the image or video is captured for personal use.
- Be advised that in certain areas, the recording of images and videos from events, performances, exhibitions, or commercial properties by means of a camera may contravene copyright or other legal rights, even if the image or video was shot for personal use.
- DO NOT use this product for any illegal or inappropriate purpose, such as spying, military operations, or unauthorized investigations. DO NOT trespass onto the private property of others. DO NOT use this product to defame, abuse, harass, stalk, threaten, or otherwise violate the legal rights of others, such as privacy and publicity rights.



• Read the Safety Guidelines for more prohibited actions before first time use.

---

## Center of Gravity Limitations

The original aircraft center of gravity has been adjusted before delivery.

The aircraft is equipped with an E-Port and E-Port Lite for connecting third-party payloads. If any third-party payloads are installed on the aircraft, make sure to adjust the aircraft center of gravity as per the guidelines and requirements. Refer to Supplements > Expansion Ports for more information.

# Normal Procedures

---



# Normal Procedures

## Airspace Environment

The dock shall be installed at an appropriate site by a DJI-authorized service provider. Make sure that all flight routes around the installation site are carried out in an open area.

## Operating Environment

- DO NOT operate the aircraft in severe weather conditions, including wind speeds exceeding 12 m/s <sup>[1]</sup>, snow, rain heavier than 2 mm/hour, and fog.
- Avoid obstacles, crowds, trees, and bodies of water (recommended height is at least 3 m above water).
- The maximum takeoff altitude is 4000 m. The performance of the aircraft and its battery is limited when flying at high altitudes. Fly with caution. When flying at a high altitude, a minimum vertical braking distance of 20 m and a minimum horizontal braking distance of 50 m are required in order to ensure flight safety.
- DO NOT use the aircraft or the dock in an environment at risk of a fire or explosion.
- Only operate the dock and the aircraft for applications in the operating temperature range. The operating temperature of the dock is -25° to 45° C (-13° to 113° F). The operating temperature of the aircraft is -20° to 45° C (-4° to 113° F). <sup>[2]</sup> In low-temperature environments, it is necessary to check whether the dock cover and the aircraft is covered with snow and ice, and whether the propellers are frozen using the livestream of the dock camera. DO NOT fly in snow, or when the temperature is -5° to 5° C (23° to 41° F) and the humidity is higher than 85%. Otherwise, the propellers may become frozen during flight, consequently affecting flight safety.
- Make sure to set an alternate landing site before flight. The aircraft will fly to the alternate landing site when the dock is not suitable for landing. Follow the instructions in the DJI Pilot 2 app to set an alternate landing site when configuring the dock. An obvious sign should be set up near the alternate landing site. Make sure that an area within a one-meter radius of the alternate landing site is clear of obstacles.

[1] The aircraft can withstand a wind speed of up to 8 m/s during takeoff and landing.

[2] When the temperature is below -20° C (-4° F), the aircraft cannot perform flight tasks.

## Flight Restrictions and Unlocking

### Geospatial Environment Online (GEO) System

The DJI Geospatial Environment Online (GEO) System is a global information system that provides real-time information on flight safety and restriction updates, and prevents UAVs from flying in restricted airspace. Under exceptional circumstances, restricted areas can be unlocked to allow flight. Prior to that, the user must submit an unlocking request based on the current restriction level in the intended flight area. The GEO System may not fully comply with local laws and regulations. Users shall be responsible for their own flight safety and must consult with the local authorities on the relevant legal and regulatory requirements before requesting to unlock a flight in a restricted area.

## GEO Zones

DJI's GEO System designates safe flight locations, provides risk levels and safety notices for individual flights and offers information on restricted airspace. All restricted flight areas are referred to as GEO Zones, which are further divided into Restricted Zones, Authorization Zones, Warning Zones, Enhanced Warning Zones, and Altitude Zones. GEO Zones include but are not limited to airports, venues of major events, areas where emergencies have occurred (such as forest fires), nuclear power plants, correctional facilities, government facilities, and military zones. Users can view real-time GEO information in DJI FlightHub 2.

By default, the GEO System limits takeoff and flight in zones that may cause safety or security concerns. A GEO Zone map that contains comprehensive information on GEO Zones around the globe is available on the official DJI website: <https://fly-safe.dji.com/nfz/nfz-query>.

The settings and alerts provided by DJI on operations within GEO Zones are only to assist the user in ensuring flight safety and DO NOT guarantee full compliance with all local laws and regulations. Before each flight task, the user is responsible for seeking advice on the relevant local laws, regulations, and requirements for the safety of the aircraft.

### Flight Restrictions in GEO Zones

The following section describes in detail the flight restrictions for the above-mentioned GEO Zones.

GEO Zone	Flight Restriction	Scenario
Restricted Zones (Red)	UAVs are prohibited from flying in Restricted Zones. If you have obtained permission to fly in a Restricted Zone, visit <a href="https://fly-safe.dji.com/unlock">https://fly-safe.dji.com/unlock</a> or contact <a href="mailto:flysafe@dji.com">flysafe@dji.com</a> to unlock the zone.	The aircraft cannot take off.
Authorization Zones (Blue)	The aircraft will not be able to take off in an Authorization Zone unless it obtains a permission to fly in the area.	To fly in an Authorization Zone, the user is required to submit an unlocking license request and synchronize the license to the dock in DJI Pilot 2 app.
Warning Zones (Yellow)	The aircraft can fly in the zone.	The aircraft can fly in the zone. Please view GEO information in DJI FlightHub 2 and stay alert.
Enhanced Warning Zones (Orange)		
Altitude Zones (Gray)	The aircraft's altitude is limited when flying inside an Altitude Zone.	The dock aircraft cannot take off, and a prompt will appear in DJI FlightHub 2 when the planned flight altitude exceeds the maximum altitude of the aircraft.

## Buffer Zone

Buffer Zones for Restricted Zones/Authorization Zones: To prevent the aircraft from accidentally flying into a Restricted or Authorization Zone, the GEO System creates a buffer zone of about 20 meters wide outside each Restricted and Authorization Zone. As shown in the illustration below, the aircraft can only take off and land away from the Restricted or Authorization Zone when inside the buffer zone. The aircraft cannot fly toward the Restricted or Authorization Zone unless an unlocking request has been approved. The aircraft cannot fly back into the buffer zone after leaving the buffer zone.

Buffer Zones for Altitude Zones: A buffer zone of about 20 meters wide is established outside each Altitude Zone. As shown in the illustration below, when approaching the buffer zone of an Altitude Zone in a horizontal direction, the aircraft will gradually reduce its flight speed and hover outside the buffer zone. When approaching the buffer zone from underneath in a vertical direction, the aircraft can ascend and descend in altitude or fly away from the Altitude Zone. The aircraft cannot fly toward the Altitude Zone. The aircraft cannot fly back into the buffer zone in a horizontal direction after leaving the buffer zone.

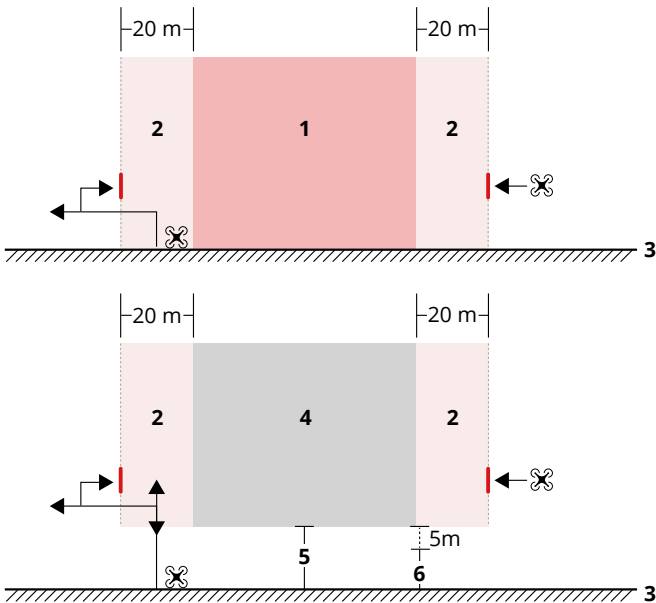

- |                                    |                    |
|------------------------------------|--------------------|
| 1. Restricted Zone/Authorized Zone | 4. Altitude Zone   |
| 2. Buffer Zone                     | 5. Altitude Limit  |
| 3. Ground                          | 6. Flight Altitude |

⚠ • When creating a flight task in Task Plan Library, make sure that the selected flight route does not pass through any GEO zones, and that the RTH altitude and flight route altitude is at least 5 m lower than the maximum flight altitude allowed in Altitude Zone. It is recommended that the flight route keeps a horizontal distance of at least 20 m away from the GEO Zones.

## Unlocking GEO Zones

To satisfy the needs of different users, DJI provides two unlocking modes: Self-Unlocking and Custom Unlocking. Users may request on the DJI Fly Safe website.

**Self-Unlocking** is intended for unlocking Authorization Zones. To complete Self-Unlocking, the user is required to submit an unlocking request via the DJI Fly Safe website at <https://fly-safe.dji.com/unlock>. Once the unlocking request is approved, the user may connect the remote controller to the USB-A port of the dock, power on the aircraft and make sure it is link to the dock, and synchronize the unlocking license to the dock using the DJI Pilot 2 app to unlock the zone. The user can designate an unlocked period during which multiple flights can be operated.

**Custom Unlocking** is tailored for users with special requirements. It designates user-defined custom flight areas and provides flight permission documents specific to the needs of different users. This unlocking option is available in all countries and regions and can be requested via the DJI Fly Safe website at <https://fly-safe.dji.com/unlock>.

For more information about unlocking, please visit <https://fly-safe.dji.com> or contact [flysafe@dji.com](mailto:flysafe@dji.com).

## Maximum Flight Altitude & Distance Restrictions

Maximum flight altitude restricts the aircraft flight altitude, while maximum flight distance restricts the aircraft flight radius around the dock. These limits can be set using DJI FlightHub 2 for improved flight safety. The maximum flight altitude is 120 m (393.7 ft) by default. Fly at altitudes lower than the maximum altitude in accordance with all local laws and regulations.<sup>[1]</sup>

[1] Maximum flight altitude restrictions vary in different regions. DO NOT fly above the maximum flight altitude set by the local laws and regulations.

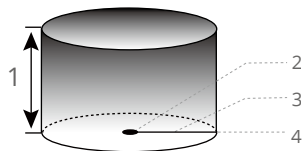

Home Point not manually updated during flight



1. Max Altitude
2. Home Point
3. Max Distance
4. Altitude of aircraft when powered on

	Flight Restrictions	DJI FlightHub 2 Prompt
Max Flight Altitude	Aircraft cannot exceed the max flight altitude value set in DJI FlightHub 2.	Flight route altitude is greater than the max altitude, the dock is unable to perform flight task.
Max Distance	The straight-line distance from the aircraft to the Home Point cannot exceed the max flight distance set in DJI FlightHub 2.	Flight route distance is greater than the max distance, the dock is unable to perform flight task.



- The aircraft cannot take off when the GNSS signal is weak.
- For safety reasons, DO NOT fly the aircraft close to airports, highways, railway stations, railway lines, city centers, or other sensitive areas.



- Open the DJI FlightHub 2 Project page, click  >  to manage the custom flight areas (user-defined operation zones) and custom GEO Zones (user-defined no-fly zones), or import obstacle data. The aircraft can bypass custom GEO Zones and the imported obstacles during RTH or when performing FlyTo tasks.

## Radio Frequency Environment

- Be extremely alert when flying near areas with magnetic or radio interference. It is recommended to connect the remote controller B during flight tests. Pay close attention to the video transmission quality and signal strength on DJI Pilot 2. Sources of electromagnetic interference include but are not limited to: high voltage lines, large-scale power transmission stations or mobile base stations, and broadcasting towers. The aircraft may behave abnormally or lose control when flying in areas with too much interference. Return to the dock and land the aircraft, and only make future task plans when the flight test is stable.
- Fly in wide open areas. Tall buildings, steel structures, mountains, rocks, or tall trees may affect the accuracy of the GNSS and block the video transmission signal.
- When using with multiple aircrafts, make sure that the distance between each aircraft is more than 10 m to avoid interference.
- Avoid interference between the dock and other wireless equipment. It is recommended to power off nearby Wi-Fi and Bluetooth devices.

## Use of Takeoff and Landing Equipment

The dock can accommodate one aircraft, from where it can take off and land. The dock can also charge the aircraft battery and provide a suitable environment for aircraft storage.

## Distance to Control Station

When the user performs automated operations remotely using DJI FlightHub 2, the aircraft

will take off from and land at the dock. It is recommended to install a protective fence so that unauthorized personnel cannot enter the area where the dock is installed. Make sure that no flight plan is performed on DJI FlightHub 2 and that the aircraft has landed inside the dock before entering the protective fence when operating the dock on site. After entering the area, make sure to press the emergency stop button of the dock.

During a flight task, the aircraft should be more than 10 m away from users to ensure safety.

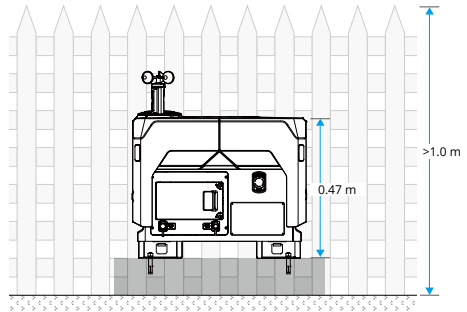
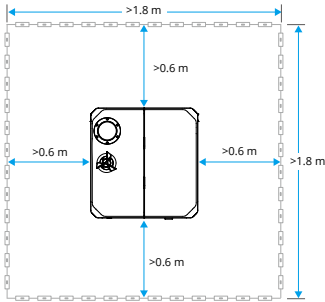

- 
- ⚠ • If it is necessary to take off and land the aircraft using the remote controller, the aircraft should be more than 10 m away from operator to ensure safety. Maintain visual line of sight with the aircraft at all times.
-

## System Assembly

The dock needs to be installed by a DJI-authorized service provider with the aircraft prepared on site at the same time, in order for the dock and the aircraft to be configured after assembly and installation.

To ensure that the dock and aircraft are properly functioning, an on-site flight test of automatic operation should be performed in DJI FlightHub 2 after completing the dock configuration.

Refer to the DJI Dock 2 Installation and Setup Manual for more information.



- Make sure to contact a DJI-authorized service provider for installation. There may be potential safety hazards if the product is installed by the user. Contact DJI Support for more information on DJI-authorized service providers.



## Pre-Flight Checklist

After adding a new flight route or changing the flight route settings, it is recommended to perform an on-site flight test to ensure normal dock operation.

### On-site Checklist

- Make sure there is no foreign matter in the battery port of the aircraft.
- Make sure the battery is installed firmly, the battery buckles are clicked into place, and the battery locking arms are firmly secured.
- Make sure the propellers are securely mounted and not damaged or deformed and that there is no foreign matter in or on the motors or propellers.
- Make sure the lenses of the vision system, gimbal cameras, the glass of the infrared sensors, and the auxiliary lights are clean and not blocked in any way.
- Make sure the covers of the microSD card slot, the USB-C assistant port (E-Port Lite), and the E-Port are firmly closed.
- Make sure that the wind speed gauge rotates properly and that the rainfall gauge surface is clear of dirt or foreign matter.
- Make sure the landing pad surface is clear of dirt or foreign matter.
- Make sure the temperature and humidity sensor inside the dock cover is not blocked in any way.
- Make sure the aircraft is correctly placed on the landing pad and the aircraft heading is aligned with the arrow mark. To ensure flight safety, make sure that there is no obstacle within 5 m of the dock.
- Make sure the emergency stop button is released.
- Modify the aircraft settings using the remote controller based on actual needs. Check the settings of the obstacle braking distance, warning distance, and gimbal camera settings in DJI Pilot 2.

## DJI FlightHub 2 Checklist

- Open the DJI FlightHub 2 project page, click  >  and check the following:
    - a. Make sure the dock status is Idle, and the aircraft status is in Standby or Powering Off.
    - b. Make sure the wind speed, temperature, and rainfall are within the reasonable range, and the dock network connection is stable.
    - c. Click Live to view the dock livestream. Make sure the dock cover surface is clear of obstacles and snow or ice.
    - d. Click Action to check the device status. Make sure the dock RTK is calibrated and converged, the satellite signal is strong, and that the device storage has enough free space.
    - e. Make sure to enable the obstacle sensing of the aircraft and enable the beacon at night. Make sure to set the max flight altitude, max flight distance, and alternate route altitude based on actual flight conditions.
  - Make sure the dock and aircraft firmware have been updated to the latest version in the Devices page.
  - Make sure that an alternate landing site is set.
  - Check the following flight route settings:
    - a. Make sure that the flight route does not pass through any GEO Zones, and that the flight route keeps a horizontal distance of at least 20 m away from the GEO Zones.
    - b. Check the takeoff point, altitude mode, and flight altitude. When flying near a GEO Zone, it is recommended to set the flight route altitude at least 5 m lower than the maximum flight altitude allowed in Altitude Zone.
  - When creating a task plan, make sure to set the RTH altitude at least 5 m lower than the maximum flight altitude allowed in Altitude Zone.
  - Pay attention to the flight altitude, flight speed, battery level, and other flight parameters during the flight test.
  - Divide the airspace for flight when multiple aircraft are operating simultaneously in order to avoid collision mid-air.
- 
-  • It is recommended to link the remote controller as controller B before flight tests for safety reasons.
- To ensure flight precision, when importing flight routes to DJI FlightHub 2, make sure the RTK signal source of the flight route is the same as the signal source used to calibrate the dock RTK. Otherwise, the actual flight trajectory of the aircraft differs from the preset flight route, and may even cause the aircraft to crash.
-



- ☀️ • After a task plan is initiated, the dock will automatically check whether the environment (such as wind speed, rainfall, and temperature) is suitable for flight tasks. To ensure flight safety, the aircraft cannot take off in the following conditions:
  - a. The wind speed is above 8 m/s.
  - b. The rainfall exceeds 2 mm/hour.
  - c. The environment temperature is below -20° C (-4° F).
  - d. The emergency stop button is pressed.
  - e. The dock power supply is disabled.
  - f. The Intelligent Flight Battery level is below 30%.
  - g. The aircraft satellite signal is weak (the aircraft satellite icon in DJI FlightHub 2 is red).
  - h. The battery lifespan is reached.
  - i. Dock cover error occurs.
  - j. The firmware of the dock and the aircraft are not compatible. Make sure to update the firmware of the dock and the aircraft to the latest version before performing a flight task.
- If the positioning accuracy is selected as RTK in Task Plan Library, the aircraft will take off and wait for the RTK to converge before performing a flight task. The aircraft will land on the dock if the RTK fails to converge.
- If a warning message appears in DJI FlightHub 2, click the message to view warning details, and follow the instructions to perform remote debugging.
- Try lowering the flight altitude and the RTH altitude to reduce the effect of a strong wind condition. Meanwhile, check the flight altitude and the RTH altitude to ensure there are no obstacles during flight or RTH.

## System Starting

### Powering on/off the Aircraft

The aircraft will automatically power on if a flight task is initiated, and the aircraft will land in the dock and automatically power off after completing the flight task.

Press, then press and hold the power button to manually power on/off the aircraft.

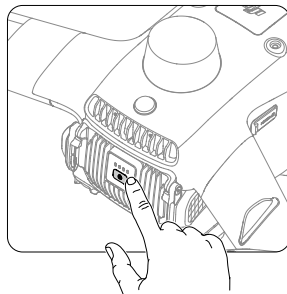

## Connecting the dock and the aircraft

The dock and the aircraft are linked and activated during dock configuration. If a different aircraft is used, follow the steps to link the dock and the aircraft:

1. Loosen the screws of the electrical cabinet door using a 2.5mm hex key. Pull to open the electrical cabinet door and view the operation panel.
2. Press, then press and hold the power button to power on the aircraft.
3. Press and hold the link button in the electrical cabinet, then press and hold the power button of the aircraft for more than five seconds. During the linking process, the dock cover status indicators will blink blue, and short beeps will sound from the dock.
4. When linking is successful, the dock status indicators will blink white.

The aircraft needs to be activated before first use. Follow the steps below for activation:

- Method 1: Make sure the dock and the aircraft are linked. Connect the USB-C port of the remote controller to the USB-A port of the dock electrical cabinet. Run DJI Pilot 2 and follow the prompts in the app to activate.
- Method 2: Power on the aircraft and the remote controller, run DJI Pilot 2, select Matrice 3D Series on the homepage to link the remote controller and the aircraft, and follow the prompts in the app to activate.



- Make sure the remote controller is connected to the internet during activation.
- 

## Calibrating the Dock RTK

The dock integrates dual RTK antennas, allowing for centimeter-level positioning when used with DJI Matrice 3D Series aircraft.

To ensure flight route accuracy, make sure the dock RTK is calibrated before an RTK flight task. The dock RTK data is already calibrated using the remote controller during dock configuration, and does not require recalibration if the dock location remains the same. If the dock is moved, recalibrate the dock location in DJI Pilot 2 using the remote controller. Refer to the Installation and Setup Manual for more information.



- Make sure the landing pad is clear of obstacles and that the RTK antennas are not covered. Otherwise, the signals will be obstructed and the positioning performance will be affected.
- When setting the alternate landing site or performing RTK tasks, DO NOT move the dock position, restart the dock, or recalibrate the dock position.
- Increased ionospheric activity or scintillation may affect the accuracy of RTK positioning. In this case, it is not recommended to calibrate the dock position.



- Users can open the DJI FlightHub 2 project page, click  >  > Action to view the dock RTK status.
-

## Connecting the Remote Controller as Controller B

To ensure flight test safety, the remote controller can be used to take control of the aircraft manually during on-site flight tests after connecting to the aircraft as controller B. Link the remote controller to the aircraft as controller B following the steps below:

1. Power on the remote controller and the aircraft.
2. Run DJI Pilot 2, select Matrice 3D Series in the homepage.

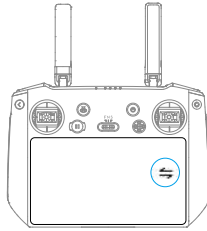

3. Tap Controller A > Switch to Controller B.

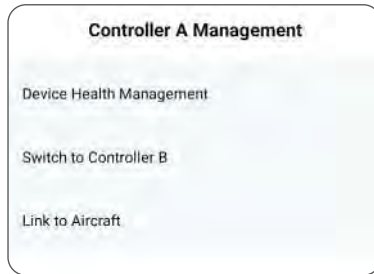

4. Press and hold the power button of the aircraft for more than four seconds. The aircraft will beep once, and its battery level LEDs blink in sequence.
5. When linking is successful, the remote controller will beep twice.





---

 • Make sure to link the dock and the aircraft first, and then link the remote controller and the aircraft.

---

## Aircraft Settings Using the Remote Controller

During on-site flight tests, users can modify the aircraft settings using the remote controller based on actual needs.

1. Link the aircraft to remote controller B.
2. Run DJI Pilot 2, tap Enter Camera View on the homepage to enter Preflight Check. Users will be directed to the camera view by default after finishing the preflight check.
3. Tap  on the upper-right of the screen to modify the aircraft settings:
  - a.  Sensing System Settings: Set the horizontal and vertical obstacle braking distance and the warning distance. Default values are recommended.
  - b.  Gimbal Settings: Perform Gimbal Auto Calibration by following the instructions.
  - c.  RTK Module: Make sure Maintain Positioning Accuracy is enabled.

## Calibrating the Aircraft

### Calibrating the Aircraft Compass

Calibrate the compass when prompted to do so in DJI Pilot 2 or DJI FlightHub 2, or when the status indicator blinks red and yellow alternately. Observe the following when calibrating the compass:

- 
-  • DO NOT calibrate the compass in locations with strong magnetic interference, such as near magnets, parking lots, or construction sites with underground reinforced concrete structures.
  - DO NOT carry ferromagnetic materials such as mobile phones during calibration.
  - DJI Pilot 2 will display a prompt if the compass is affected by strong interference after calibration is complete. Follow the on-screen instructions to resolve the compass issue.
  - If a compass interference prompt appears in DJI FlightHub 2 or DJI Pilot 2, the aircraft cannot take off. Calibrate the compass as soon as possible to ensure the flight performance of the aircraft.
  - It is recommended to calibrate the compass before taking off in the following scenarios: taking off for the first time after the aircraft has been stored for an extended period of time, taking off after being placed near strong magnetic objects, or taking off at night.
-

## Calibration Procedure

Perform the calibration in an open area, link the aircraft to remote controller B and gain aircraft control, and then follow the steps below to complete the calibration.

1. Run DJI Pilot 2 and enter the camera view on the home screen. Tap **\*\*\* >  > Sensor Status > Compass**, and tap **Calibrate Compass** to start the calibration. The aircraft status indicator will be solid yellow to indicate calibration has started.
2. Hold the aircraft horizontally 1.5 m (4.92 ft) above the ground and rotate the aircraft 360 degrees around the center axis. The aircraft status indicators will be solid green.

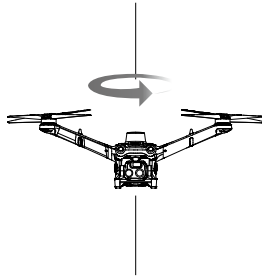

3. Hold the aircraft vertically as shown in the figure, and rotate the aircraft 360 degrees around the center axis.



4. Re-calibrate the aircraft if the aircraft status indicators blink red.

- ⚠️ • If the aircraft status indicator blinks red and yellow alternately after calibration is completed, this indicates the current location is unsuitable for flying due to the level of magnetic interference. Choose a new location.
- ☀️ • A prompt will appear in DJI Pilot 2 if compass calibration is required before takeoff. The prompt will disappear after the calibration is complete.
- If the prompt appears again in DJI Pilot 2 when placing the aircraft on the ground after calibration, try moving the aircraft to a different location.

## Calibrating the Gimbal

Enter the camera view of DJI Pilot 2 and tap **•••** >  to begin Gimbal Auto Calibration.

## Takeoff/Landing

### Automatic Takeoff/Landing

The dock cover opens after initiating a flight task, and the aircraft takes off from the dock. Once the aircraft takes off, the dock cover will close and the aircraft will begin to perform the flight task.

After completing the flight route, the aircraft flies above the dock, and the dock cover automatically opens to allow the aircraft to land. After the aircraft lands, the dock cover automatically closes.

### Manual Takeoff/Landing

The remote controller can be used to control the aircraft manually during on-site flight tests. The Combination Stick Command (CSC) listed below is used to start and stop the aircraft motors.

#### Takeoff

Perform a Combination Stick Command (CSC) as shown below to start the motors. Once the motors have started spinning, release both sticks simultaneously. Gently push the throttle stick up to take off.

Take off immediately once the motors are spinning. Otherwise, the aircraft may lose balance, drift, or even take off by itself which may risk causing damage or injury.

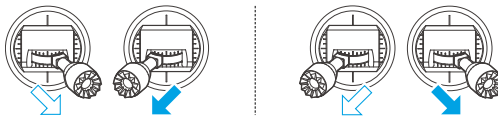

## Landing

To land, push the throttle stick down to descend until the aircraft touches the ground. There are two methods to stop the motors:

Method 1: When the aircraft has landed, push the throttle stick down and hold until the motors stop.

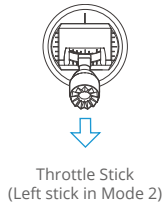

Method 2: Push the throttle stick down, and perform the same CSC that was used to start the motors. Release both sticks once the motors have stopped.

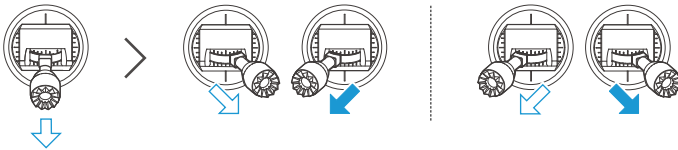

- 
- ⚠**
- Spinning propellers can be dangerous. Stay away from spinning propellers and motors. DO NOT start the motors in confined spaces or where there are people nearby.
  - Maintain control of the remote controller as long as the motors are running.
  - DO NOT stop the motors mid-flight unless in an emergency situation where doing so will reduce the risk of damage or injury.
  - It is recommended to use Method 1 to stop the motors. When using Method 2 to stop the motors, the aircraft may roll over if it is not completely grounded. Use Method 2 with caution.
  - After landing, power off the aircraft before turning off the remote controller.
-

# Planned and Manual Flight

## Flight Procedure

The operating procedure in DJI FlightHub 2 and the automated flight procedure of the dock and the aircraft is shown in the figure below:

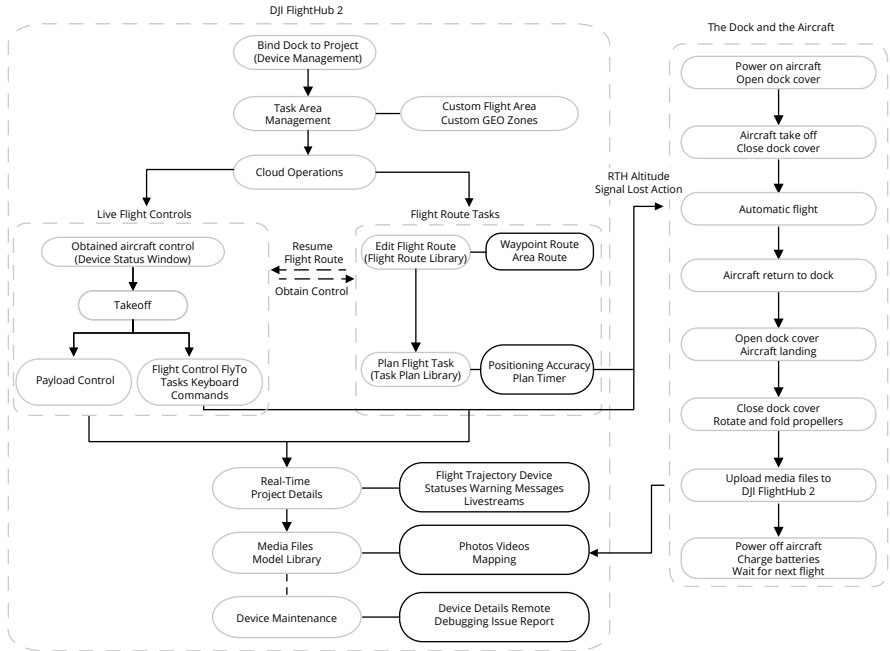

• For more details, refer to the DJI FlightHub 2 User Guide which is available on <https://fh.dji.com/user-manual/en/overview.html>.

## Flight Route Tasks

DJI FlightHub 2 provides flight route and task plan management. Users can create and edit flight routes in Flight Route Library, and designate flight routes and create task plans in Task Plan Library based on their actual needs. The aircraft will take off automatically according to the flight route and the preset Plan Timer.

Go to the DJI FlightHub 2 User Guide for more information on editing flight routes and planning flight route tasks.





## Live Flight Controls

DJI FlightHub 2 supports sending commands directly to the aircraft that is bound to the dock and remotely operating the aircraft. Go to the DJI FlightHub 2 User Guide and refer to the Live Flight Controls section for more information.

## On-site Flight Controls

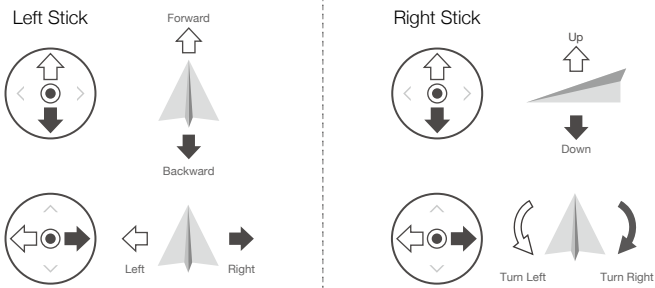
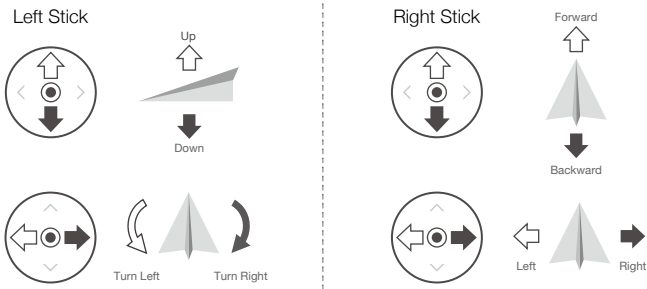
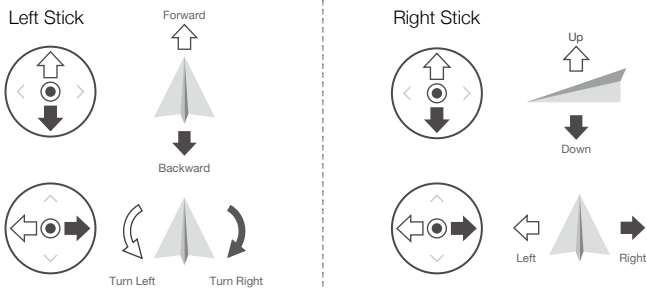
The remote controller can be used to control the aircraft manually during on-site flight tests after gaining aircraft control. The control sticks can be operated in Mode 1, Mode 2, or Mode 3, as shown below.



The default control stick mode of the remote controller is Mode 2. Run DJI Pilot 2 and enter the camera view, tap **•••** >  to modify the control stick mode for the remote controller.

## Flight Modes

The aircraft supports N mode (Normal), S mode (Sport), and F mode (Function), and the aircraft flies in N mode by default. Flight modes can be switched using the remote controller B after taking aircraft control. The aircraft only supports N mode when used with the dock.

### Normal Mode

In N mode, the aircraft uses GNSS to locate and stabilize itself when the GNSS signal is strong. When the GNSS is weak, but the lighting and other environmental conditions are sufficient, it uses the vision system. When the obstacle sensing is enabled and the lighting is sufficient, the maximum tilt angle of the aircraft is 25°, and the maximum forward flight speed is 15 m/s.

### Sport Mode

In S mode, the aircraft uses GNSS for positioning and the aircraft is more responsive to control stick movements. Note that obstacle sensing is disabled and the maximum flight speed is 21 m/s in S mode.

### Function Mode

F mode can be set to T-mode (Tripod mode) or A-mode (Attitude mode) in DJI Pilot 2. In T-mode, the aircraft is more stable when taking photos or videos. A-mode must be used with caution.

The aircraft automatically changes to A-mode when the vision system is unavailable or disabled and when the GNSS signal is weak or the compass experiences interference. In A-mode, the aircraft may be more easily affected by its surroundings. Environmental factors such as wind can result in horizontal shifting, which may present hazards, especially when flying in confined spaces. The aircraft will not be able to hover or brake automatically, therefore the user needs to land the aircraft as soon as possible to avoid accidents.

- 
- ☀️ • DO NOT switch from N mode to other modes unless the pilot is sufficiently familiar with the aircraft behavior under each flight mode. Make sure to enable Multiple Flight Modes in DJI Pilot 2 before switching from N mode to other modes.
- 
- ⚠️ • The vision system is disabled in S mode, which means the aircraft cannot sense obstacles on its route automatically. The user must stay alert to the surrounding environment and control the aircraft to avoid obstacles.
  - The maximum speed and braking distance of the aircraft significantly increase in S mode. A minimum braking distance of 30 m is required in windless conditions while the aircraft is flying forward, backward, left, or right.
  - A minimum braking distance of 10 m is required in windless conditions while the aircraft is ascending and descending in S mode or N mode.
  - The responsiveness of the aircraft significantly increases in S mode, which means a small control stick movement on the remote controller translates into the aircraft moving a large distance. Make sure to maintain adequate maneuvering space when flying with the remote controller.
  - When switching the GNSS to the BeiDou satellite positioning system in DJI Pilot 2, the aircraft only uses a single positioning system and the satellite search capability becomes poor. Fly with caution.
- 

## RTH

The Return to Home (RTH) function returns the aircraft back to the dock or the alternate landing site when the GNSS signal is strong. Alternate Landing will be triggered if the dock is not suitable for landing. In this case, the aircraft will fly to and land at the alternate landing site.

Flight tasks will be interrupted and RTH will be triggered if any of these situations occur:

- The aircraft approaches the GEO Zones, or the flight distance approaches the maximum distance.
- The GNSS signal becomes weak during a flight route task.
- The user actively triggers RTH in DJI FlightHub 2.
- The Intelligent Flight Battery level is too low.
- If the control signal is lost, Signal Lost Action (Return to Home or Continue Task) will be triggered.
- There is strong wind during a flight route task.
- RTH will be triggered if the motors are overloaded or overheated. Auto landing will be triggered if there is critical motor overheating warning.
- When performing RTK flight tasks, if the flight distance is too far, RTK positioning accuracy may decrease. To ensure flight safety, the flight route task will be interrupted and RTH will be triggered.

- ⚠ • Make sure to set an appropriate RTH altitude when creating a flight task plan. The RTH altitude should be at least 5 m lower than the altitude limit of the Altitude Zone.
  - During RTH, the aircraft will exit RTH when the GNSS signal becomes weak (the icon becomes red), or the GNSS is unavailable.
  - GEO Zones may affect the RTH. Avoid flying near GEO Zones.
  - The aircraft will exit RTH and hover if the lighting and environment conditions are insufficient to complete RTH, even if the vision system is working properly.
- 

## Advanced RTH

Advanced RTH can be triggered in three ways: the user actively triggers, the aircraft has low battery, or the control signal is lost. When Advanced RTH is triggered, the aircraft will automatically plan the best RTH path, which will be displayed in DJI FlightHub 2 and will adjust according to the environment.

The user can cancel RTH after gaining aircraft control in DJI FlightHub 2. RTH can also be cancelled by pressing the Flight Pause button or the RTH button on remote controller B after gaining aircraft control. After exiting RTH, users will regain control of the aircraft.

## Trigger Method

### The user actively triggers RTH

Advanced RTH can be initiated by clicking Return to Home in the device status window in DJI FlightHub 2.

During on-site flight tests, advanced RTH can also be initiated by pressing and holding the RTH button on the remote controller after gaining aircraft control.

### Aircraft low battery

To avoid unnecessary danger caused by insufficient battery power, the aircraft automatically calculates if the battery power is sufficient to return to the Home Point according to the current position, environment, and flight speed. The flight task will be interrupted and RTH will be triggered when the battery level is low and only enough to complete an RTH flight.

Users can click Cancel RTH in the device status window to exit RTH. The aircraft will not trigger low battery RTH again if RTH is cancelled. If RTH is cancelled following the warning, the battery may not have enough power for the aircraft to land safely, which may lead to the aircraft crashing or being lost.

The aircraft will land automatically if the current battery level can only support the aircraft long enough to descend from its current altitude. Auto landing cannot be cancelled. During auto landing, users cannot control the aircraft movement in DJI FlightHub 2, but can still gain aircraft control using remote controller B to control the horizontal movement and the descent speed of the aircraft during auto landing. If there is sufficient power, the throttle stick can be used to make the aircraft ascend at a speed of 1 m/s.

During auto landing, gain control using remote controller B and move the aircraft horizontally to find an appropriate place to land as soon as possible. The aircraft will fall if the user keeps pushing the throttle stick upward until the power is depleted.

The battery level indicator is displayed in the device status window:



1. Auto landing (Red)
2. Power required to return home (Yellow)
3. Sufficient battery level (Green)
4. Estimated Remaining Flight Time

Battery Level Warning	Implication	Flight
Low Battery RTH	The remaining battery level is only enough for the aircraft to fly to the Home Point.	Flight task will be interrupted and the aircraft will enter RTH. Dock landing detection will be triggered before landing.
Auto Landing	The remaining battery level is only enough for the aircraft to descend from its current altitude.	The aircraft will land automatically and dock landing detection will be triggered.
Estimated Remaining Flight Time	The estimated remaining flight time of the aircraft is based on its current battery level.	/

**⚠** • The colored zones and the estimated remaining flight time on the battery level indicator are automatically adjusted according to the current location and status of the aircraft.

## Loss of Control Signal

The signal lost action can be set in DJI FlightHub 2:

- In Live Flight Control: Open the device status window, click Flight Settings > On Signal Lost to set the signal lost action to Return to Home, Hover, or Continue.
- In Flight Route Task: Open the Task Plan Library, and click Create Plan to set the signal lost action during a flight route task to Return to Home or Continue Task.

When the signal lost action is set to RTH, the GNSS signal is strong, the Home Point was successfully recorded, and the compass is functioning normally, RTH automatically activates after the control signal is lost for six seconds or above.

When the lighting is sufficient and the vision system is working normally, DJI FlightHub 2 will display the RTH path that was generated by the aircraft before the control signal was lost and return to home using Advanced RTH according to the RTH settings. The aircraft will remain in RTH even if the control signal is restored. DJI FlightHub 2 will update the RTH path accordingly.

When the lighting is insufficient and the vision system is not available, the aircraft will perform the Original Route RTH procedure. The aircraft will enter or remain in Preset RTH path if the signal is restored during RTH. The Original Route RTH procedure is as follows:

1. The aircraft brakes and hovers in place.
2. When RTH begins:
  - If the RTH distance (the horizontal distance between the aircraft and the Home Point) is farther than 50 m, the aircraft adjusts its orientation and flies backward for 50 m on its original flight route before entering Preset RTH path.
  - If the RTH distance is farther than 5 m but less than 50 m, it adjusts its orientation and flies to the Home Point in a straight line at the current altitude.
  - The aircraft lands immediately if it is less than 5 m from the Home Point when RTH begins.
3. The aircraft lands and the motors stop after reaching the Home Point.

- 
-  • The aircraft may not be able to return to the Home Point normally if the GNSS signal is weak or unavailable. The aircraft may enter ATTI mode if the GNSS signal becomes weak or unavailable after RTH is triggered by loss of control signal, and the aircraft will hover in place for a while before landing.
- It is important to set a suitable RTH altitude before each flight. Set the RTH altitude in the device status window or in Task Plan Library in DJI FlightHub 2.
  - When the lighting is insufficient and the environment is not suitable for the vision system, the aircraft cannot avoid obstacles during RTH.
  - The aircraft may not be able to return to the Home Point when the wind speed is too high. Fly with caution.
  - RTH cannot be triggered when the aircraft is landing.
  - Be aware of small or fine objects such as tree branches or power lines or transparent objects such as water or glass during RTH. In an emergency, cancel RTH and control the aircraft manually using DJI FlightHub 2.
-

## RTH Procedure

1. The Home Point is recorded. The default Home Point is the dock.
2. Advanced RTH is triggered.
3. The aircraft brakes and hovers in place. When RTH begins:
  - The aircraft lands immediately if the RTH distance is less than 5 m.
  - If the RTH distance is farther than 5 m, the aircraft will plan the best path according to the RTH settings, lighting, and environmental conditions.
4. The aircraft will fly automatically according to the RTH settings, environment, and transmission signal during RTH.
5. The aircraft begins landing after reaching the dock.

## Advanced RTH Settings

RTH settings are available for Advanced RTH. Optimal Route Planning can be enabled in the device status window under Live Flight Controls before taking off. Optimal RTH Route Planning can also be enabled in the Task Plan Library when creating a task plan.

- 
-  It is recommended to enable Obstacle Data in DJI FlightHub 2 for the optimal route planning. Go to the DJI FlightHub 2 User Guide and refer to the Map Task Area section for more information.
- 

### 1. Optimal RTH Path:



- If the lighting is sufficient and the environment is suitable for the vision system or Obstacle Data is enabled, the aircraft will automatically plan the optimal RTH path and adjust the altitude according to environmental factors, regardless of the RTH Altitude settings. The optimal RTH path means the aircraft will travel the shortest distance possible, reducing the amount of battery power used and increasing the flight time.
- If the lighting is insufficient and the environment is not suitable for vision system and Obstacle Data is disabled, the aircraft will perform Preset RTH path based on the RTH Altitude settings.

2. Preset RTH Path:



RTH Distance and Altitude		Lighting and Environment Conditions	
		Suitable for Vision System	Unsuitable for Vision System
RTH distance is more than 50 m	Current altitude < RTH altitude	The aircraft will plan the RTH path, fly to an open area while bypassing obstacles, ascend to the RTH Altitude, and return to home using the best path.	The aircraft will ascend to the RTH altitude, and fly to the Home Point in a straight line at the RTH altitude.
	Current altitude ≥ RTH altitude	The aircraft will return to home using the best path at the current altitude.	The aircraft will fly to the Home Point in a straight line at the current altitude.
RTH distance is within 5-50 m			

When the aircraft is approaching the Home Point, if the current altitude is higher than the RTH altitude, the aircraft will intelligently decide whether to perform descending while flying forward according to the surrounding environment, lighting, the set RTH altitude, and the current altitude. When the aircraft is above the Home Point, the current altitude of the aircraft will not be lower than the set RTH altitude. **Note that when the lighting is insufficient and the environment is not suitable for the vision system, and the Obstacle Data is disabled in DJI FlightHub 2, the aircraft cannot avoid obstacles. Make sure to set a safe RTH altitude and pay attention to the surrounding environment to ensure flight safety.**



The RTH plan in different environments, RTH trigger methods, and RTH settings is as follows:

Lighting and Environment Conditions		
	Suitable for Vision System	Unsuitable for Vision System
RTH Triggerring Conditions	The aircraft can bypass obstacles and avoid GEO Zones and custom GEO Zones (user-defined no-fly zones).	The aircraft cannot bypass obstacles but can avoid GEO Zones and custom GEO Zones (user-defined no-fly zones).
The user actively triggers RTH	The aircraft will perform RTH based on RTH setting: <ul style="list-style-type: none"> <li>• Optimal RTH path</li> <li>• Preset RTH path</li> </ul>	Preset RTH path
Aircraft low battery		
Loss of control signal		Original route RTH procedure, preset RTH path will be performed when the signal is restored

-  • During Advanced RTH, the aircraft will adjust the flight speed automatically to suit environmental factors such as wind speed and obstacles.
- The aircraft cannot avoid small or fine objects such as power lines or towers. It is recommended to disable Optimal Route Planning. Make sure to set the RTH Altitude higher than all obstacles.
  - It is recommended to mark the waypoint with obstacle above as no-return point to ensure the flight safety during RTH.
  - DO NOT update the Home Point after gaining control using remote controller B. Otherwise, the aircraft may not return to the dock if the Home Point is updated.
  - If the max altitude is set below the current altitude during RTH, the aircraft will descend to the max altitude first and then continue to return to home.
  - The RTH Altitude cannot be changed during RTH.
  - If there is a large difference in the current altitude and the RTH altitude, the amount of battery power used cannot be calculated accurately due to wind speeds at different altitudes. Pay extra attention to the battery power and warning prompts in DJI FlightHub 2.
  - During Advanced RTH, if the lighting condition and environment becomes unsuitable for the vision system and if Obstacle Data is disabled, the aircraft will perform Preset RTH path. In this case, the aircraft cannot bypass obstacles. Make sure to set an appropriate RTH altitude before performing RTH.
  - If the aircraft reaches the altitude limit of the aircraft current location or of the Home Point while it is ascending during Preset RTH path, the aircraft stops ascending and returns to the Home Point at the current altitude. Pay attention to flight safety during RTH.

- ⚠️ • If the Home Point location is in an Altitude Zone while the aircraft is outside the Altitude Zone, when the aircraft reaches the Altitude Zone, it will fly below the altitude limit, which may be lower than the set RTH altitude. Fly with caution.
  - The aircraft will avoid any GEO Zones encountered when it is flying forward during Advanced RTH. Pay attention to flight safety during RTH.
  - In rainy or foggy weather, the vision system is unavailable and the RTH route may be inaccurate, which can cause flight safety risks. DO NOT fly when it is rainy, smoggy, or the visibility is lower than 100 m.
- 

## Dock Landing Detection

Dock landing detection is activated during landing and the procedure is as follows:

1. If dock landing detection determines the dock is suitable for landing, the aircraft will land on the landing pad directly.
  2. If the dock is not suitable for landing (when the dock cover fails to open or when the emergency stop button is pressed), the aircraft will fly to the alternate landing site. If an alternate landing site is not set, the aircraft will hover above the dock, and will start descending only when the battery level is too low.
  3. If dock landing detection is not operational (when the dock and the aircraft are disconnected), or the aircraft fails to land on the dock due to bad weather conditions, the aircraft will descend to 5 m (9.8 ft) above the ground and hover. The aircraft will fly to the alternate landing site when the battery level is less than 20%. If an alternate landing site is not set, the aircraft will hover above the dock, and will start descending only when the battery level is too low.
- 

- ⚠️ • Make sure to set an alternate landing site when configuring the dock. Otherwise, the aircraft may crash-land if the dock is not suitable for landing, damaging the aircraft and the dock.
- 

## System Shutdown

After completing a flight task, the aircraft will land on the landing pad, the dock cover will close and the dock will charge the aircraft. The media files will be automatically uploaded to the cloud before the aircraft powers off.

---

- 🔌 • If the remote controller is used to take control of the aircraft manually during on-site flight tests, push the throttle stick down and hold to stop the motors after landing. Press, then press and hold the power button to power off aircraft and the remote controller.
-

## Post-Flight Inspection

1. Make sure that the aircraft has landed in the dock, and the dock covers are closed properly.
  2. Make sure the media files are automatically uploaded to the cloud, and the media files can be captured properly during flight.
  3. Make sure to view the warning details of the dock and aircraft in DJI FlightHub 2.
  4. Check if there is any error message in DJI FlightHub 2.
  5. Check if the aircraft can be powered off and charged by the dock properly.
  6. Check if the dock is working normally.
- 
-  • Inspect the following items if the remote controller is used to take control of the aircraft manually during on-site flight tests.
- a. Make sure that the aircraft is powered off.
  - b. Check the aircraft structure, clean the dirt and dust, and replace any loose or damaged parts.
  - c. Make sure the aircraft is placed properly on the landing pad and the aircraft heading is consistent with the arrow mark, and the propellers are at 90° with each other.
  - d. Make sure that the battery port on the aircraft is clean and dry.
-

# Emergency Procedures

---

# Emergency Procedures

## General Information

This chapter introduces how to handle the aircraft or control station if one of the following emergencies occur.

## Fire

A prompt will appear in DJI FlightHub 2 and the flight controller will reduce the power of the aircraft when the Intelligent Flight Battery temperature is too high. The battery will be locked for future use if the temperature is too high during flight and cannot be used again after landing.

Follow the instructions below if the Intelligent Flight Battery catches fire:

1. If the battery catches fire when it is being charged using a charging device, make sure that personal safety is guaranteed, power off the charging device immediately, and disconnect the battery from the charging device. If the battery catches fire when the battery is in the aircraft, make sure that personal safety is guaranteed and remove the battery from the aircraft immediately.
2. Move the flammable materials surrounding the battery to a safe distance of more than 5 m .
3. If the fire is controllable, use a large amount of sand to cover the location of the fire and pour cold water to cool the battery until there is no smoke coming out. Use fire-resistant gloves or other protective tools to avoid direct contact with the battery. Move the battery to a container with an appropriate amount of salt solution, and then fully immerse the battery in the solution. Leave the container in a cool place for more than 72 hours to fully discharge the battery and take out the battery and dispose it.
4. If the fire is uncontrollable, double check that there are no flammable materials surrounding the battery, extend the safety distance to more than 10 m, and evacuate people from the surrounding area. Wait until the battery burns out and the fire is extinguished in order to avoid any further accidents.

## Loss of C2 Link

The aircraft will perform the signal lost action if the control signal is lost during flight. Refer to the RTH > Advanced RTH > Trigger Method, and then the Loss of Control Signal section for more information.

## Loss of Navigation Systems

When using fixed RTK positioning, the aircraft will switch to GNSS if RTK is unavailable during flight. If GNSS is also unavailable, the aircraft will switch to Attitude (ATTI) mode automatically to stabilize its attitude.

## Control Station Failures

Control station failures include the following situations.

### Loss of Control Signal

If the control signal is lost during flight, the aircraft will perform signal lost action. Refer to the RTH > Advanced RTH > Trigger Method, and then the Loss of Control Signal section for more information.

### DJI FlightHub 2 Failure

If DJI FlightHub 2 crashes during automatic operations while the control signal is normal, the C2 link between the aircraft and the control station is still in good condition, so the aircraft will continue performing the current operation until RTH is triggered by low battery level.

### Alternate Landing

If the dock is determined unsuitable for landing, alternate landing will be triggered. The aircraft will ascend to the alternate route altitude, then fly to the alternate landing site for landing. Open DJI FlightHub 2, Click Devices > Dock, and then  to check the alternate route altitude.

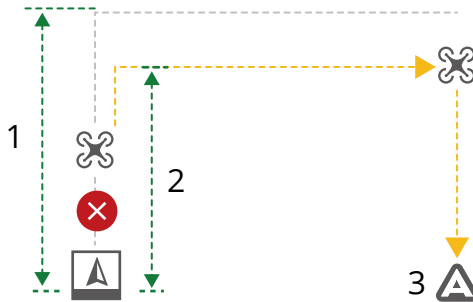

1. RTH Altitude
2. Alternate Route Altitude
3. Alternate Landing Site



• To ensure flight safety, make sure to set an alternate landing site and suitable alternate route altitude when configuring the dock.

## Gaining Control Using Remote Controller B

DJI RC Pro Enterprise remote controller can be linked with the aircraft as controller B. During on-site flight tests, the remote controller can take control and manually control flight if any emergency occurs. Follow the steps below to gain aircraft control using the remote controller:

1. Run DJI Pilot 2 and tap Enter Camera View on the homepage. Users will be directed to the camera view by default after finishing the preflight check.
2. Tap  on the upper left corner to gain the aircraft control and the gimbal control.



- The remote controller should be purchased separately. Pay attention to flight safety when manually controlling with the remote controller.
- DO NOT update the Home Point after gaining control. Otherwise the aircraft cannot return to the dock.
- DO NOT take off using the remote controller if a flight task is initiated from the dock after gaining control with remote controller B. In this case, restart the aircraft before taking off using the remote controller.

## Dual Control of the Dock and the Remote Controller

1. The aircraft supports dual control mode, and can be controlled by the dock (controller A) and remote controller B. By default, the dock is given control of both the aircraft and the gimbal camera, while remote controller B is not given any control.
2. When the remote controller has full control, the control sticks are used for controlling the aircraft and the dials for adjusting gimbal movement.
3. When the remote controller has control, it can be used to trigger or cancel RTH, modify aircraft settings, and download or replay media files.
4. The dock will automatically take control of the aircraft before each flight task. A control transfer mechanism will be triggered if either the dock or the remote controller is disconnected from the aircraft. If the remote controller disconnects from the aircraft, control will be transferred to the dock. If the dock disconnects from the aircraft, the remote controller will receive a notification that the user may manually take over aircraft control. If the pilot of the remote controller chooses not to take over aircraft control, the aircraft will automatically perform the signal lost action. If the pilot of the connected remote controller does not choose either option within a specified time, the aircraft will also perform the signal lost action.
5. If the disconnected remote controller reconnects with the aircraft during the flight, it will not resume its previous control and will by default have no control of any device.
6. RTH cannot be triggered in DJI FlightHub 2 after remote controller B takes control. The dock will automatically take control of the aircraft if remote controller B is disconnected from the aircraft (such as when the remote controller is powered off or the video transmission signal is lost). The aircraft can continue the flight task in progress.
7. During a flight task, if the remote controller takes control in N mode, the aircraft will continue the flight task. If the flight mode is switched to another mode after taking control, the flight route task will be interrupted and RTH will be triggered. If the remote controller

takes control in S mode or F mode, the flight route task will be interrupted and RTH will be triggered.

8. The remote controller can be used to modify the flight control system, the sensing system, other aircraft settings, and the camera settings.
9. Both the firmware of the dock and the aircraft can be updated in DJI FlightHub 2, but the remote controller can only be used to update the firmware of the remote controller.
10. Users can upload the logs of both the dock and the aircraft in DJI FlightHub 2, but can only upload the logs of remote controller using the remote controller.
11. Remote controller B cannot be used to update the Fly Safe database, and cannot upload unlocking license for GEO Zones.

## Emergency Stop Button

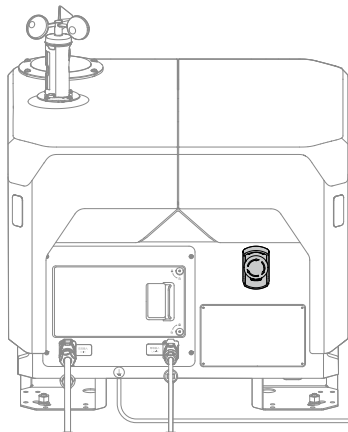

The dock has one emergency stop button. In an emergency, press the emergency stop button to stop all dock movements when operating or maintaining the dock. The status indicators blink red and yellow alternatively after pressing the emergency stop button.

If the aircraft is powered on but the motors are not running, the aircraft cannot take off after pressing the emergency stop button. If the emergency stop button is pressed when the aircraft is performing a flight task, the aircraft will fly to the alternate landing site after completing the flight task.

- 
-  • Pull out or rotate the button clockwise to release the emergency stop button before performing any dock operations (e.g. dock cover control).
-



## Other Failures

When other dock failures occur, such as when the dock has no power supply, no network connection, or when the dock cover cannot be opened, perform troubleshooting.

## Flyaway

When the aircraft is connected to the dock, the coordinates of the aircraft will be uploaded to the cloud and can be viewed in DJI FlightHub 2.

When the aircraft is disconnected from the dock, the last recorded time and coordinates of the aircraft will be displayed in the device status window in DJI FlightHub 2. Users can click the information to center the aircraft location in the middle of the map and then right-click to create a PinPoint to help locate the aircraft during a search. The information will not be displayed after the aircraft re-connects to the dock.

# Handling, Servicing and Instructions for Maintenance

---

# Handling, Servicing and Instructions for Maintenance

## Ground Handling

Refer to the DJI Dock 2 Maintenance Manual for more information.

## Installation, Removal, and Storage

### Installation and Removal

The dock must be installed and set up by an authorized service provider for installation. Unauthorized installation and set up may lead to safety risks. Contact DJI Support for more information on DJI-authorized service providers.

Make sure to remove the power cable connector, Ethernet cable connector, and earth wire from the dock before storage. The landing pad, external circulating fan, and external circulating vents can be removed from the dock for maintenance. Refer to the DJI Dock 2 Maintenance Manual for more information.

Follow the steps to remove or install the propellers for the aircraft. Make sure to remove the battery from the aircraft before installation and removal.

## Propellers

### Removing the Propellers

1. Power off the aircraft and remove the battery.
2. Remove the propeller blade screws using a 2.0mm hex key.
3. Remove the propeller adapter and the rubber washers.

### Installing the Propellers

There are two types of propellers, which are designed to spin in different directions. Marks are used to indicate which propellers should be attached to which motors. Make sure to match the propellers and motors by following the instructions below:

1. Match the marks on the motors and propellers, and install the propellers to the motors with the corresponding marks.
2. Use a 2.0mm hex key to replace the propellers for the DJI Matrice 3D Series aircraft. Tighten the screws and make sure that the screw torque is greater than 5 kgf.cm, and that the washers are flat and not twisted.
3. Use the screw glue (recommended model: 243) on the screws when replacing the propellers.

- ⚠ • The propellers need to be replaced in pairs. Make sure to use the provided washers and screws when replacing the propellers. DO NOT reuse old washers or screws. Otherwise, the screws may become loose, consequently affecting flight safety.
- It is recommended to contact DJI Support or an authorized service provider for propeller replacement.

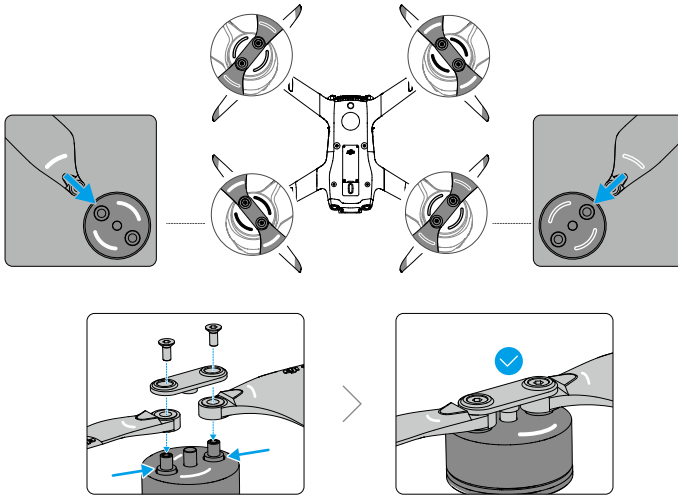

- ⚠ • Power off the aircraft before examining or replacing any propellers.
- The propeller blades are sharp. Handle with care.
- Only use official DJI propellers. DO NOT mix propeller types.
- Propellers are consumable components. Purchase additional propellers if necessary.
- Make sure that all propellers are in good condition, unfolded, and firmly tightened before placing the aircraft on the landing pad. DO NOT use aged, chipped, or broken propellers.
- Make sure that the motors are mounted securely and can rotate smoothly. DO NOT take off if a motor is stuck and unable to rotate freely.
- DO NOT attempt to modify the structure of the motors.
- DO NOT block any of the ventilation holes on the motors or the aircraft body.
- Make sure the ESCs sound normal when powered on.
- To avoid injury, stay away from rotating propellers or motors.
- DO NOT touch or let hands or body parts come in contact with the motors after flight, as they may become hot.
- Return to the dock and land the aircraft as soon as possible if a motor overloading or overheating warning prompt appears in DJI FlightHub 2.

## Storage

### Dock Storage

If the dock is not used immediately, follow the requirements as shown below for temporary storage:

- Store it in a dry, rainproof, and fireproof place with no corrosive materials.
- Protect it from erosion and damage caused by wildlife.
- Make sure to check that the outer packaging of the dock is in good condition regularly. Make sure to charge the backup battery for at least 6 hours every three months.
- If the dock is removed from storage and not used for a period of time, place it in a water-resistant bag sealed with adhesive tape and then store it in the original packaging with a desiccant.
- DO NOT tilt or invert the dock or place items on top of the box when the dock is stored in the box.

### Aircraft Storage

When the dock is powered on and working normally, the air conditioning system can adjust the environment temperature making the aircraft suitable for storage. If the aircraft is stored separately, follow the requirements as shown below:

- Keep the aircraft and parts clean and dry and store them in a cool dry place. Recommended storage temperature: between -25° and 55° C (-13° and 131° F).
- Make sure small parts are stored properly to avoid loss. Small parts, such as cables and straps are dangerous if swallowed. Keep all parts out of reach of children and animals.
- Remove the battery from the aircraft when stored.

### Battery Storage

When the dock is powered on and working normally, the air conditioning system can adjust the environment temperature making the battery suitable for storage. If the batteries are stored separately, refer to the Safety Guidelines and follow the instructions on battery storage.

## IP Rating

### IP Rating of the Dock

1. Under stable laboratory conditions, DJI Dock 2 achieves an IP55 protection rating by IEC 60529 standards when used with DJI Matrice 3D Series aircrafts. The protection rating is not permanent and may lower over an extended period of time. Maintain the device on a regular basis.
2. The dock does not achieve an IP55 protection rating in the following circumstances:
  - The electrical cabinet door is not firmly closed.
  - The mounting screws of the wind speed gauge are not firmly tightened.
  - The dock cover is not firmly closed (It is abnormal if dock cover has a gap larger than 20 mm).

- The dock shell is cracked or the water-resistant adhesive is aged or damaged.
3. The body surface may become discolored after long-term use. However, such color change does not affect the performance and IP rating of the dock.

## IP Rating of the Aircraft



1. Under stable laboratory conditions, the DJI Matrice 3D Series aircraft achieves an IP54 protection rating of IEC 60529 standards when equipped with the Intelligent Flight Battery. The protection rating is not permanent and may lower over an extended period of time.
  - DO NOT fly when the amount of rainfall exceeds 2 mm/hour.
  - Make sure the battery surfaces, battery ports, and the battery compartment ports and surfaces are dry before inserting the battery.
  - The product warranty does not cover water damage.
2. The aircraft does not achieve an IP54 protection rating in the following circumstances:
  - Batteries other than the DJI Matrice 3D Series Intelligent Flight Battery are used.
  - The covers for the ports are not attached correctly.
  - The dongle compartment cover is not firmly secured.
  - The aircraft shell is cracked or the water-resistant adhesive is aged or damaged.
3. The aircraft body is made of flame retardant materials to improve safety. As such, the body surface may become discolored after long-term use. However, such color change does not affect the performance and IP rating of the aircraft.

# Charging, Conditioning, and Replacing Batteries

## Charging Batteries

### Charging via the Dock

The battery can be charged via the dock when it is inserted into the aircraft. The charging temperature range of the battery is 5° to 45° C (41° to 113° F). Charging will begin after the battery temperature reaches the charging temperature range. In this case, the charging time will be extended.

To charge the Intelligent Flight Battery, open the DJI FlightHub 2 Project page, click  >  > Action > enable Remote Debugging, and then click Charge.



• Users can also charge the battery in the Device Maintenance page: open the DJI FlightHub 2 Project page, click Dock >  > enable Remote Debugging, and then click Charge.



• After the dock is powered on, DO NOT place any metal objects such as rings or any electronic devices on the landing pad, or touch the landing pad surface when placing the aircraft on the landing pad to avoid burns.

• To ensure safety, the dock cannot charge the aircraft battery when the dock cover is opened.



---

## Charging Mode

Charging Mode can be set as Schedule or Standby in DJI FlightHub 2. When the dock is in idle status, the battery level and the temperature inside the dock can be automatically modified to meet different scenarios. Two hours before a Timed flight task, the dock will automatically charge the batteries and the flight task will be performed after charging is completed.

Schedule mode is suitable for performing regular tasks such as patrol inspections. The battery will be charged between 55% and 60% when no task is distributed.

Standby mode is suitable for performing urgent tasks such as fire rescue. The battery will be charged between 85% and 90% when no task is distributed.

Switching charging modes: Open the DJI FlightHub 2 project page, click  > , and then Action to switch to different charging modes.

- 
-  • Battery level may be low under Schedule mode. If the Plan Timer is selected as Immediate, Low Battery RTH may be triggered during the flight task.
  - Maintaining a high power level in Standby mode will affect battery life. It is recommended to select Schedule mode if the scenario is not urgent.
- 

## Using the Charging Kit



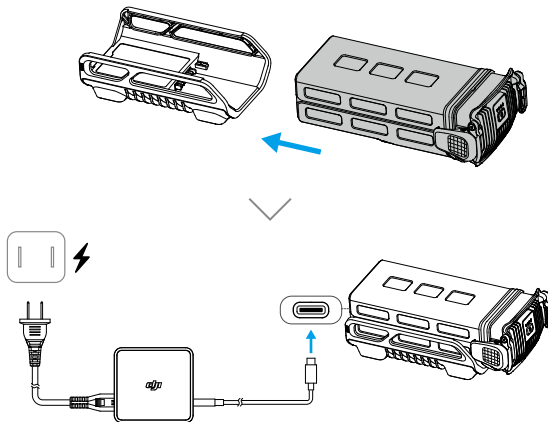

When the battery is not inserted into the aircraft, it can be charged using the charging kit (sold separately). Follow the steps below to charge the battery:

1. Insert the Intelligent Flight Battery into the battery port. Connect the charging base to a power outlet (100-240 VAC, 50/60 Hz) using the DJI USB-C Power Adapter (100W).
2. Refer to the Status LED Descriptions for more information about the blinking patterns of the status LED.
3. Disconnect the Intelligent Flight Battery from the charging base when charging is complete.



-  • It is recommended to use the DJI 100W USB-C Power Adapter or other USB Power Delivery chargers.

### Status LED Descriptions

Blinking Pattern		Description
 —	Solid yellow	The battery is not inserted.
	Pulses green	Charging the battery.
 —	Solid green	The battery is fully charged.
	Blinks yellow	Temperature of battery or the charging base is too low or too high. Wait until the battery and the charging base cools down, no further operation needed.
 —	Solid red	Power supply or battery error. Remove and reinsert the battery or unplug and plug in the adapter.

### Conditioning Batteries

The Intelligent Flight Battery will perform a self-evaluation and the dock will automatically maintain the battery to ensure optimal battery performance. If a warning message appears in DJI FlightHub 2, click the message to view warning details, and follow the instructions to perform battery maintenance.

When the battery life is approaching, a prompt will appear in DJI FlightHub 2. If users continue to use the battery, the dock cannot perform flight tasks when the battery life is reached.

-  • The battery contains hazardous chemicals, DO NOT dispose of the battery in a regular waste disposal container. Strictly follow local laws and regulations regarding the disposal and recycling of batteries.
- Batteries that are over-discharged, swollen, involved in a crash, come into contact with liquid, damaged, or leaky must be disposed. DO NOT use any battery in such a condition to avoid damage or injury. Contact a professional battery disposal or recycling agent for further assistance.



## Replacing Batteries

The battery should not be used again if any accident occurs. Users should replace the battery immediately. See details below.

1. DO NOT use swollen, leaking, or damaged batteries.
2. DO NOT use a battery that has been dropped.
3. If the battery falls into water while inserted in an aircraft during flight, take it out immediately, and put it in a safe and open area. DO NOT use the battery again.
4. If the battery cannot be discharged completely, replace the battery and contact a professional battery disposal or recycling agent for assistance on disposal.

## Cleaning and Maintaining

Refer to the DJI Dock 2 Maintenance Manual for more information.

# Supplements

---

# Supplements

This chapter introduces the specifications of the whole system, additional functions of the aircraft, the operation of optional equipment, and other relevant information.

## Specifications

### Dock

#### General

Product Name	DJI Dock 2
Total Weight <sup>[1]</sup>	34 kg (without aircraft)
Dimensions <sup>[2]</sup>	Dock Cover Opened: 1228×583×412 mm (L×W×H) Dock Cover Closed: 570×583×465 mm (L×W×H)
Input Voltage	100-240 V (AC), 50/60 Hz
Input Power	Max. 1000 W
Operating Temperature <sup>[3]</sup>	-25° to 45° C (-13° to 113° F)
Ingress Protection Rating	IP55
Number of Drones Accommodated	1
Max Allowable Landing Wind Speed	8 m/s
Max Operating Altitude	4000 m
Receiving Frequency of RTK Base Station Satellite	Simultaneously receive: GPS: L1 C/A, L2 BeiDou2: B1I, B2I, B3I BeiDou3: B1I, B3I GLONASS: L1, L2 Galileo: E1, E5B
Positioning Accuracy of RTK Base Station	Horizontal: 1 cm + 1 ppm (RMS) Vertical: 2 cm + 1 ppm (RMS)

#### Charging Performance

Output Voltage	28 V DC
Charging Time <sup>[4]</sup>	32 minutes

#### Video Transmission

Video Transmission System	O3 Enterprise
Operating Frequency	2.4000-2.4835 GHz 5.725-5.850 GHz
Antennas	Built-in 4 antennas, 2T4R, supports intelligent switching

Transmitter Power (EIRP)	2.4 GHz: <33 dBm (FCC), <20 dBm (CE/SRRC/MIC) 5.8 GHz: <33 dBm (FCC); <14 dBm (CE); <23 dBm (SRRC)
<b>Air Conditioning System</b>	
Operating Voltage	28 V DC
Air Conditioning Type	TEC Air Conditioning
<b>Backup Battery</b>	
Battery Capacity	12 Ah
Output Voltage	12 V
Battery Type	Lead-acid battery
Battery Life <sup>[5]</sup>	>5 hours
<b>Network Access</b>	
Ethernet Access	10/100/1000Mbps adaptive Ethernet port
<b>Security Camera (External)</b>	
Resolution	1920×1080
Field of View (FOV)	151°
Auxiliary Light	Auxiliary White Light
<b>Security Camera (Internal)</b>	
Resolution	1920×1080
Field of View (FOV)	151°
Auxiliary Light	Auxiliary White Light
<b>Lightning Protection</b>	
AC Power Port	20 kA (rated value), meets EN 61643-11 Type 2 and IEC 61643-1 Class II protection level requirements
Ethernet Port	10 kA (I <sub>total</sub> ), meets EN/IEC 61643-21 Category C protection level requirements
<b>Supported Software</b>	
Applications	DJI Pilot 2 (connects to DJI Dock 2 via DJI RC Pro Enterprise for deployment and commissioning)
Cloud Platform	DJI FlightHub 2 (supported by default) Third-party cloud platforms (accessed through DJI Cloud API)
<b>Expansion Capability</b>	
Open Protocol	DJI Cloud API
Edge computing	Supports data communication with external switches

- [1] The actual product weight may vary due to differences in batch materials and external factors.
- [2] The above data does not include the height of the wind speed gauge (145 mm), but includes the height of the mounting base brackets (55 mm).
- [3] When the temperature is below -20° C (-4° F), the aircraft cannot perform flight tasks.

- [4] The data was measured when charging the aircraft (when powered off) from 20% to 90% in a 25° C (77° F) environment.
- [5] Measured with a fully charged backup battery in a 25° C (77° F) environment. After a power outage, the dock does not support functions such as aircraft charging, air conditioning, and heating of the dock cover and wind speed gauge. Always check any malfunctions in time.

## Aircraft

General	
Net Weight <sup>[1]</sup>	1410 g
Max Takeoff Weight	1610 g
Dimensions	335×398×153 mm (L×W×H, without propellers)
Wheelbase	Diagonal Wheelbase: 463.2 mm Left-Right Wheelbase: 359.9 mm Front-Rear Wheelbase: 291.4 mm
Max Ascent Speed	6 m/s (Normal mode) 8 m/s (Sport mode)
Max Descent Speed	6 m/s (Normal mode) 6 m/s (Sport mode)
Max Horizontal Speed (at sea level, no wind)	Normal Mode, With Obstacle Sensing Enabled: 15 m/s flying forward, 12 m/s flying backward, 10 m/s flying sideways Sport Mode: 21 m/s flying forward, 18 m/s flying backward, 16 m/s flying sideways
Max Wind Speed Resistance	During Operation: 12 m/s During Takeoff/Landing: 8 m/s
Max Take-off Altitude	4000 m
Max Flight Time <sup>[2]</sup>	50 minutes
Max Hovering Time <sup>[3]</sup>	40 minutes
Max Operating Radius <sup>[4]</sup>	10 km
Max Flight Distance <sup>[5]</sup>	43 km
Max Pitch Angle	25° (Normal mode) 25° (Sport mode)
Max Angular Velocity	250°/s
Global Navigation Satellite System	GPS + Galileo + BeiDou + GLONASS (GLONASS is supported only when the RTK module is enabled.)
Hovering Accuracy Range (windless or breezy)	Vertical: ±0.1 m (with vision positioning) ±0.5 m (with GNSS positioning) ±0.1 m (with RTK positioning)  Horizontal: ±0.3 m (with vision positioning) ±0.5 m (with GNSS positioning) ±0.1 m (with RTK positioning)
Operating Temperature	-20° to 45° C (-4° to 113° F)

Ingress Protection Rating	IP54	
Motor Model	2607	
Propeller Model	1149, foldable, non-quick release	
RTK Module	Integrated on the aircraft	
Beacon	Integrated on the aircraft	
<b>Wide-Angle Camera</b>	<b>DJI Matrice 3D</b>	<b>DJI Matrice 3TD</b>
Image Sensor	4/3 CMOS Effective Pixels: 20 MP	1/1.32-inch CMOS, Effective Pixels: 48 MP
Lens	FOV: 84° Format Equivalent: 24mm Aperture: f/2.8-f/11 Focus: 1 m to ∞	FOV: 82° Format Equivalent: 24mm Aperture: f/1.7 Focus: 1 m to ∞
Lens Defogging	The wide-angle camera supports lens defogging.	
ISO Range	100-6400	100-25600
Shutter Speed	Electronic Shutter: 8-1/8000 s Mechanical Shutter: 8-1/2000 s	Electronic Shutter: 8-1/8000 s
Max Image Size	5280×3956	8064×6048
Still Photography Modes	Single: 20 MP Timed: 20 MP, 0.7/1/2/3/5/7/10/15/20/30/60 s Smart Low-Light: 20 MP Panorama: 20 MP (raw image); 100 MP (stitched image)	Single: 12 MP, 48 MP Timed: 12 MP, 48 MP, 0.7/1/2/3/5/7/10/15/20/30/60 s <sup>[6]</sup> Smart Low-Light: 12 MP Panorama: 12 MP (raw image); 100 MP (stitched image)
Video Resolution	H.264 4K: 3840×2160@30fps FHD: 1920×1080@30fps	
Video Bitrate	4K: 130 Mbps FHD: 70 Mbps	4K 85 Mbps FHD: 30 Mbps
Supported File System	exFAT	
Photo format	JPEG	
Video Format	MP4 (MPEG-4 AVC/H.264)	
<b>Tele Camera</b>	<b>DJI Matrice 3D</b>	<b>DJI Matrice 3TD</b>
Image Sensor	1/2-inch CMOS, Effective Pixels: 12 MP	
Lens	FOV: 15° Format Equivalent: 162mm Aperture: f/4.4 Focus: 3 m to ∞	

Lens Defogging	The tele camera supports lens defogging.	
ISO Range	100-6400	100-25600
Shutter Speed	Electronic Shutter: 8-1/8000 s	
Max Image Size	4000×3000	
Photo format	JPEG	
Video Format	MP4 (MPEG-4 AVC/H.264)	
Still Photography Modes	Single: 12 MP Timed: 12 MP, 0.7/1/2/3/5/7/10/15/20/30/60 s Smart Low-Light: 12 MP	
Video Resolution	H.264 4K: 3840×2160@30fps FHD: 1920×1080@30fps	
Video Bitrate	4K: 130Mbps FHD: 70 Mbps	4K: 85 Mbps FHD: 30 Mbps
Digital Zoom	8× (56× hybrid zoom)	
<b>Infrared Camera (DJI Matrice 3TD)</b>		
Thermal Imager	Uncooled VOx Microbolometer	
Pixel Pitch	12 μm	
Frame Rate	30 Hz	
Lens <sup>[7]</sup>	FOV: 61° Format Equivalent: 40mm Aperture: f/1.0 Focus: 5 m to ∞	
Sensitivity	≤50 mk@F1.0	
Temperature Measurement Method	Spot Measurement, Area Measurement	
Temperature Measurement Range	-20° to 150° C (-4° to 302° F, High Gain Mode) 0° to 500° C (32° to 932° F, Low Gain Mode)	
Palette	White Hot/Black Hot/Tint/Iron Red/Hot Iron/Arctic/Medical/Fulgurite/Rainbow 1/Rainbow 2	
Photo format	JPEG (8-bit) R-JPEG (16-bit)	
Video Resolution	Normal Mode: 640×512@30fps UHR Infrared Image Mode: 1280×1024@30fps (With the UHR Infrared Image function enabled, the aircraft can automatically enable or disable UHR Infrared Image mode according to the ambient light brightness.)	
Video Bitrate	6 Mbps	



Video Format	MP4 (MPEG-4 AVC/H.264)
Still Photography Modes	Single Normal Mode: 640×512 UHR Infrared Image Mode: 1280×1024 Timed Normal Mode: 640×512, 0.7/1/2/3/5/7/10/15/20/30/60 s UHR Infrared Image Mode: 1280×1024, 0.7/1/2/3/5/7/10/15/20/30/60 s
Digital Zoom	28×
Infrared Wavelength	8-14 μm
Infrared Temperature Measurement Accuracy	±2° C or ±2% (using the larger value)
<b>Gimbal</b>	
Stabilization	3-axis mechanical gimbal (tilt, roll, pan)
Mechanical Range	Tilt: -135° to +45° Roll: -45° to +45° Pan: -27° to +27°
Controllable Range	Tilt: -90° to +35° Pan: Not controllable
Max Control Speed (tilt)	100°/s
Angular Vibration Range	±0.005°
<b>Sensing</b>	
Sensing Type <sup>[8]</sup>	The aircraft supports six-directional obstacle sensing.
Forward	Measurement Range: 0.5-21 m; Detection Range: 0.5-200 m Effective Sensing Speed: Flight Speed ≤15 m/s FOV: Horizontal 90°, Vertical 90°
Backward	Measurement Range: 0.5-23 m Effective Sensing Speed: Flight Speed ≤12 m/s FOV: Horizontal 90°, Vertical 90°
Lateral	Measurement Range: 0.5-15 m Effective Sensing Speed: Flight Speed ≤10 m/s FOV: Horizontal 104°, Vertical 90°
Upward	Measurement Range: 0.5-21 m Effective Sensing Speed: Flight Speed ≤6 m/s FOV: Front and Back 90°, Left and Right 90°

Downward	Measurement Range: 0.5-14 m Effective Sensing Speed: Flight Speed $\leq$ 6 m/s FOV: Front and Back 95°, Left and Right 110°
Operating Environment	Forward, Backward, Left, Right, and Upward: Surfaces with discernible patterns and adequate lighting (lux > 15) Downward: Diffuse reflective surface with diffuse reflectivity > 20% (e.g. walls, trees, people) and adequate lighting (lux > 15)
<b>Video Transmission</b>	
Video Transmission System	DJI O3 Enterprise Transmission
Live View Quality	720p/30fps, 1080p/30fps (with DJI RC Pro Enterprise) 540p/30fps, 720p/30fps, 1080p/30fps (with DJI FlightHub 2)
Operating Frequency <sup>[9]</sup>	2.4000-2.4835 GHz 5.150-5.250 GHz (CE: 5.170-5.250 GHz) 5.725-5.850 GHz
Max Transmission Distance <sup>[10]</sup> (unobstructed, free of interference)	DJI Matrice 3D: 15 km (FCC), 8 km (CE/SRRC/MIC) DJI Matrice 3TD: 15 km (FCC), 8 km (CE/SRRC/MIC)
Max Transmission Distance <sup>[11]</sup> (unobstructed, with interference)	Strong Interference (dense buildings, residential areas, etc.): 1.5-3 km (FCC/CE/SRRC/MIC) Medium Interference (suburban areas, city parks, etc.): 3-9 km (FCC), 3-6 km (CE/SRRC/MIC) Low Interference (open spaces, remote areas, etc.): 9-15 km (FCC), 6-8 km (CE/SRRC/MIC)
Max Download Speed <sup>[12]</sup>	5 MB/s (with DJI Dock 2) 15 MB/s (with DJI RC Pro Enterprise)
Lowest Latency	The video transmission latency from the aircraft to the dock is approximately 110 to 150 milliseconds (affected by the actual environmental conditions). The video transmission latency from the dock to DJI FlightHub 2 is affected by the actual network conditions and the configuration of the computer.
Antenna	4 antennas, 2T4R
Transmitter Power (EIRP)	2.4 GHz: < 33 dBm (FCC), < 20 dBm (CE/SRRC/MIC) 5.1 GHz: < 23 dBm (CE) 5.8 GHz: < 33 dBm (FCC/SRRC), < 14 dBm (CE)
<b>Storage</b>	
Supported Memory Cards	Aircraft: U3/Class10/V30 or above is supported. A list of recommended microSD cards can be found below.

Recommended microSD Cards	Aircraft: SanDisk Extreme 32GB V30 A1 microSDHC SanDisk Extreme PRO 32GB V30 A1 microSDHC SanDisk Extreme 512GB V30 A2 microSDXC Lexar 1066x 64GB V30 A2 microSDXC Kingston Canvas Go! Plus 64GB V30 A2 microSDXC Kingston Canvas React Plus 64GB V90 A1 microSDXC Kingston Canvas Go! Plus 128GB V30 A2 microSDXC Kingston Canvas React Plus 128GB V90 A1 microSDXC Kingston Canvas React Plus 256GB V90 A2 microSDXC Samsung PRO Plus 256GB V30 A2 microSDXC
------------------------------	--

**Battery**

Capacity	7811 mAh
Voltage	14.76 V
Max Charging Voltage	17.0 V
Battery Type	Li-ion 4S
Chemical System	LiNiMnCoO <sub>2</sub>
Energy	115.2 Wh
Weight	544 g
Cycle Count	400
Charging Temperature	5° to 45° C (41° to 113° F)

**Power Adapter**

Input	100-240 V (AC), 50-60 Hz, 2.5 A
Output Power	100 W
Output <sup>[13]</sup>	Max output power of 100 W (total)

**Charging Base**

Input	USB-C: 5-20 V, 5.0 A
Output	Battery Port: 12-17 V, 8.0 A
Rated Power	100 W
Charging Type	One battery charged at a time
Charging Temperature	5° to 40° C (41° to 104° F)

- [1] This value includes the weight of the battery, propellers, and a microSD card, but does not include third-party payloads. The actual product weight may vary due to differences in batch materials and external factors.
- [2] Measured in a controlled test environment. Specific test conditions are as follows: flying forward at a constant speed of 46.8 kph in a windless laboratory environment at 20 meters above sea level, in photo mode (without photo-taking operation during flight), with Obstacle Avoidance Action set to Off, and from 100% battery level until 0%. Results may vary depending on the environment, actual use, and firmware version.
- [3] Measured with the DJI Matrice 3D series drones hovering in a windless environment at 20 meters above sea level and from 100% battery level until 0%. Results may vary depending on the environment, actual

use, and firmware version.

- [4] Measured in an environment of approximately 25° C (77° F) with a safe battery level of 25%, ambient wind speed of approximately 4 m/s, round-trip flight speed of approximately 15 m/s, and hovering operation of 10 minutes. Results may vary depending on the environment, actual use, and firmware version.
- [5] Measured with DJI Matrice 3D/3TD flying at a constant speed of 54 kph in a windless environment at 20 meters above sea level and from 100% battery level until 0%. Results may vary depending on the environment, actual use, and firmware version.
- [6] The 0.7s and 1s intervals are not supported when taking 48MP timed photos.
- [7] DO NOT expose the infrared camera lenses to strong sources of energy such as the sun, lava, or laser beams. Otherwise, the camera sensor may become burnt, leading to permanent damage.
- [8] The aircraft has a 10° blind spot in the upper rear area. Fly with caution.
- [9] In some countries and regions, the 5.1GHz and 5.8GHz frequency bands are prohibited, or the 5.1GHz frequency band is only allowed for indoor use. Refer to local laws and regulations for more information.
- [10] Measured in an unobstructed outdoor environment free of interference. The above data shows the farthest communication range for one-way, non-return flights under each standard. Pay attention to RTH reminders in DJI FlightHub 2 during flight.
- [11] Measured with the aircraft flying (without third-party payloads) in unobstructed environments with typical interference. The above data shows the farthest communication range for one-way, non-return flights under each standard. Pay attention to RTH reminders in DJI FlightHub 2 during flight.
- [12] Measured in a laboratory environment with little interference in countries or regions that support both 2.4 GHz and 5.8 GHz. Download speeds may vary depending on the actual conditions.
- [13] When both ports are used, the power adapter will dynamically allocate the output power of the two ports according to the load power, and the maximum output power of one of the ports is 82 W.

## Firmware Update

### Using DJI FlightHub 2

1. Power on the aircraft and the dock. Make sure the aircraft and the dock are linked, and the battery level of the aircraft is higher than 50%.
2. Open DJI FlightHub 2, and click Devices > Dock.
3. Click Can Update, and a prompt will appear in the window indicating the firmware version and updates.
4. Select the checkbox on the left to upgrade device firmware in batches.
5. Click Update, the firmware will be downloaded automatically.
6. The firmware of both the dock and the aircraft will be updated simultaneously. If the aircraft is not placed inside the dock, only the dock firmware will be updated.
7. The aircraft and the dock will restart automatically after the firmware update is complete.

⚠ • Make sure DJI FlightHub 2 is connected to the internet during the whole update process.

- 💡 • The Intelligent Flight Battery installed on the aircraft will be updated to the latest firmware version.
- Users cannot operate the aircraft or the dock during a firmware update. The aircraft and the dock will be available after the update is complete or cancelled.

### Using DJI Assistant 2 (Enterprise Series)

Make sure that the computer is connected to the internet and that the device has sufficient power before updating the firmware. The aircraft firmware update follows the same steps as those of the dock firmware update. Take the dock firmware update as an example:

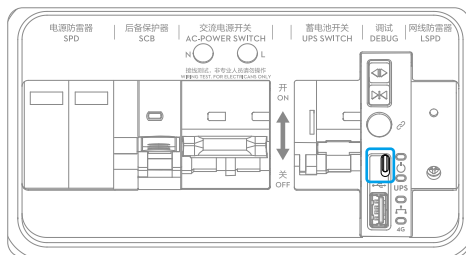

1. Open the electrical cabinet and power on the dock. Connect the computer to the USB-C port of the dock.
2. Run DJI Assistant 2 and log in with a DJI account.
3. Select DJI Dock 2, and click the firmware update button on the left.
4. Select the firmware version and click Start Update. The firmware will be downloaded and updated automatically.
5. The DJI device will restart automatically after the firmware update is complete.

- 
-  • Make sure the AC power supply of the dock is normal before firmware update. If there is no AC power supply and the dock is only powered by the backup battery, firmwares cannot be updated using DJI FlightHub 2 or DJI Assistant 2.
- 

## Expansion Ports

The aircraft is equipped with an E-Port that allows access to third-party payloads such as loud speakers and spotlights. The E-Port lite can be used to connect parachute payloads when the E-Port is connected to other devices. The dock reserves a space inside the dock cover for storing the third-party payload, which facilitates the expansion of the aircraft operating capabilities.

- 
-  • To ensure flight safety, make sure to follow the Payload Development Criteria when developing PSDK payloads. Visit <https://developer.dji.com/payload-sdk/> to view the documentation and the DJI Enterprise Ecosystem Solution Catalogue to learn more about the payload development criteria and the recommended payloads.
- The E-Port supports high power output and standard PSDK functions, while the E-Port Lite only supports a low power output of 5 V and PSDK parachute payloads.
- 

## Third-Party Payload Requirements

- Installing a third-party payload will shorten the flight time and reduce the aircraft wind resistance. Make sure to install the payload as needed.
- The third-party payload should have the protection rating of IP54 or above in order not to reduce the working stability or the service life of the aircraft.
- The port of the third-party payload connecting to the aircraft should have a water-resistant rubber ring.

## Installation Requirements

- The size of the reserved storage space inside the dock cover is 150 mm × 150 mm × 100 mm (length×width×height).
- The height of the PSDK payload must not exceed 70 mm.
- After installing the payload, make sure that the third-party payload does not block the aircraft vision system to avoid affecting the obstacle-sensing performance.

- Make sure that the payload is installed securely to avoid risk of falling payload during flight tasks, which will seriously affect flight safety.
- Make sure to seal the ports properly when connecting the payload to the aircraft. Use sealants if necessary. If any of the seals fail and water leaks into the aircraft, it will seriously affect flight safety.

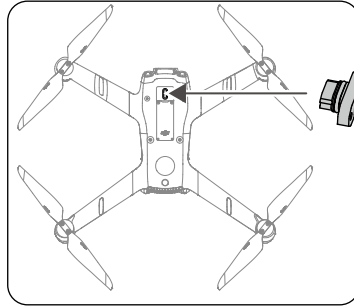

## Third-Party Cloud Platform

Based on Cloud API, users can tailor a customized management system for the dock or quickly connect it to a third-party cloud platform, facilitating efficient and convenient private configuration. Visit <https://developer.dji.com/cloud-api/> for more information at cloud API.

Users can bind the dock to a third-party cloud platform using DJI Pilot 2 when configuring the dock. Refer to Installation and Setup Manual for more information.

## FAR Remote ID Compliance Information

The unmanned aircraft system is equipped with a Remote ID system that meets the requirements of 14 CFR Part 89.

- The aircraft automatically initiates a pre-flight self-test (PFST) of the Remote ID system before takeoff and cannot take off if it does not pass the PFST <sup>[1]</sup>. The results of the PFST of the Remote ID system can be viewed in a DJI flight control app such as DJI Pilot 2 or in a DJI cloud platform such as DJI FlightHub 2.
- The aircraft monitors the Remote ID system functionality from pre-flight to shut down. If the Remote ID system malfunctions or has a failure, an alarm will be displayed in a DJI flight control app such as DJI Pilot 2 or in a DJI cloud platform such as DJI FlightHub 2.
- The user shall keep the DJI flight control app running in the foreground and always allow it to obtain the location information of the remote controller when using the DJI flight control app to fly the aircraft.
- Developers who develop third-party applications based on the DJI Mobile SDK shall obtain and display the PFST results and the failure status of the Remote ID system during operation by calling specific APIs <sup>[2]</sup>.

- Developers who develop third-party platforms based on the DJI Cloud API shall obtain and display the PFST results and the failure status of the Remote ID system during operation by calling specific APIs <sup>[3]</sup>.
- You can visit the official website of FAA to learn more about aircraft registration and Remote ID requirements.

#### Footnotes

- [1] The pass criterion for PFST is that the hardware and software of the Remote ID required-data source and transmitter radio in the Remote ID system are functioning properly.
- [2] For detailed APIs information, please visit <https://developer.dji.com/mobile-sdk/>
- [3] For detailed APIs information, please visit <https://developer.dji.com/cloud-api/>



WE ARE HERE FOR YOU



Contact  
DJI SUPPORT

The content is subject to change without prior notice.  
Download the latest version from



<https://enterprise.dji.com/dock-2/downloads>

If you have any questions about this document, contact DJI by sending a message to [DocSupport@dji.com](mailto:DocSupport@dji.com).

DJI and MATRICE are trademarks of DJI.

Copyright © 2024 DJI All Rights Reserved.