

dji MINI 4 PRO

User Manual

v1.0 2023.09

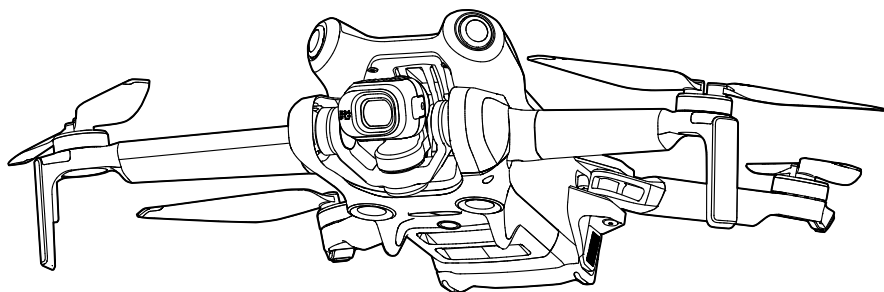



This document is copyrighted by DJI with all rights reserved. Unless otherwise authorized by DJI, you are not eligible to use or allow others to use the document or any part of the document by reproducing, transferring or selling the document. Users should only refer to this document and the content thereof as instructions to operate DJI UAV. The document should not be used for other purposes.

Searching for Keywords

Search for keywords such as “battery” and “install” to find a topic. If you are using Adobe Acrobat Reader to read this document, press Ctrl+F on Windows or Command+F on Mac to begin a search.

Navigating to a Topic

View a complete list of topics in the table of contents. Click on a topic to navigate to that section.

Printing this Document

This document supports high resolution printing.

Using this Manual

Legend

⚠ Important

💡 Hints and Tips

📖 Reference

Read Before the First Flight

DJI™ provides users with tutorial videos and the following documents.

1. Safety Guidelines
2. Quick Start Guide
3. User Manual

It is recommended to watch all tutorial videos and read the safety guidelines before using for the first time. Prepare for your first flight by reviewing the quick start guide and refer to this user manual for more information.

Video Tutorials

Go to the address below or scan the QR code to watch the tutorial videos, which demonstrate how to use the product safely:



<https://s.dji.com/guide66>

Download the DJI Fly App

Make sure to use DJI Fly during flight. Scan the QR code above to download the latest version.

- ⚠ • The remote controller with screen has the DJI Fly app already installed. Users are required to download DJI Fly to their mobile device when using the remote controller without screen.
- The Android version of DJI Fly is compatible with Android v7.0 and later. The iOS version of DJI Fly is compatible with iOS v11.0 and later.

* For increased safety, flight is restricted to a height of 98.4 ft (30 m) and a range of 164 ft (50 m) when not connected or logged into the app during flight. This applies to DJI Fly and all apps compatible with DJI aircraft.

Download DJI Assistant 2

Download DJI ASSISTANT™ 2 (Consumer Drones Series) at:

<https://www.dji.com/downloads/softwares/dji-assistant-2-consumer-drones-series>

-  • The operating temperature of this product is -10° to 40° C. It does not meet the standard operating temperature for military-grade application (-55° to 125° C), which is required to endure greater environmental variability. Operate the product appropriately and only for applications that meet the operating temperature range requirements of that grade.
-

Contents

Using this Manual	3
Legend	3
Read Before the First Flight	3
Video Tutorials	3
Download the DJI Fly App	3
Download DJI Assistant 2	4
Product Profile	9
Introduction	9
Feature Highlights	9
Using for the First Time	10
Preparing the Aircraft	10
Preparing the Remote Controller	12
Activating the Aircraft	13
Binding the Aircraft and Remote Controller	13
Firmware Update	13
Diagram	14
Aircraft	14
DJI RC 2 Remote Controller	15
DJI RC-N2 Remote Controller	16
Flight and Safety	19
Flight Environment Requirements	19
Operating the Aircraft Responsibly	20
Flight Restrictions	20
GEO (Geospatial Environment Online) System	20
Flight Limits	20
Flight Altitude and Distance Limits	21
Unlocking GEO Zones	22
Pre-Flight Checklist	22
Basic Flight	23
Auto Takeoff/Landing	23
Starting/Stopping the Motors	23
Controlling the Aircraft	25
Takeoff/Landing Procedures	26
Video Suggestions and Tips	26
Intelligent Flight Mode	27

FocusTrack	27
MasterShots	34
QuickShots	35
Hyperlapse	37
Waypoint Flight	40
Cruise Control	45
Aircraft	48
Flight Mode	48
Aircraft Status Indicators	49
Return to Home	50
Advanced RTH	51
Landing Protection	56
Precision Landing	56
Vision Systems and 3D Infrared Sensing System	57
Detection Range	57
Using the Vision Systems	58
Advanced Pilot Assistance Systems	60
Landing Protection	60
Flight Recorder	61
Propellers	61
Attaching the propellers	61
Detaching the propellers	61
Intelligent Flight Battery	63
Battery Features	63
Using the Battery	64
Charging the Battery	65
Inserting/Removing the Battery	69
Gimbal and Camera	69
Gimbal Profile	69
Gimbal Operation Modes	70
Camera Profile	71
Storing and Exporting Photos and Videos	72
QuickTransfer	72
Usage	72
Remote Controller	75
DJI RC 2	75
Operation	75

Remote Controller LEDs	80
Remote Controller Alert	80
Optimal Transmission Zone	81
Linking the Remote Controller	81
Operating the Touchscreen	82
Advanced Features	84
DJI RC-N2	85
Operation	85
Battery Level LEDs	88
Remote Controller Alert	89
Optimal Transmission Zone	89
Linking the Remote Controller	90
DJI Fly App	92
Home	92
Camera View	93
Button Descriptions	93
Screen Shortcuts	97
Settings	97
Safety	97
Control	98
Camera	99
Transmission	100
About	100
Appendix	102
Specifications	102
Firmware Update	110
Using DJI Fly	110
Using DJI Assistant 2 (Consumer Drones Series)	110
Maintenance Instructions	110
Troubleshooting Procedures	111
Risk and Warnings	112
Disposal	112
Battery Disposal	112
C0 Certification	113
MTOM Statement	113
FAR Remote ID Compliance Information	114
Aftersales Information	115

Product Profile

This chapter introduces the major features of the product.

Product Profile

Introduction

DJI Mini 4 Pro features both an omnidirectional vision system and a 3D infrared sensing system, it is capable of hovering and flying indoors and outdoors, and can automatically Return to Home while sensing obstacles in all directions. The aircraft also boasts a foldable and compact design, weighing less than 249 g. The aircraft has a maximum flight time of 34 minutes when used with the Intelligent Flight Battery, and 45 minutes with the Intelligent Flight Battery Plus.

The aircraft is compatible with both the DJI RC 2 and DJI RC-N2 remote controllers. Refer to the Remote Controller chapter for more information.

Feature Highlights

Gimbal and Camera: With a fully stabilized 3-axis gimbal and a 1/1.3" sensor camera, DJI Mini 4 Pro is able to shoot 4K 60fps HDR and 4K 100fps video and 48MP photos. It also supports switching between Landscape mode and Portrait mode with one tap in DJI Fly. The newly added 10-bit D-Log M color mode brings a more convenient experience for post-production color correction, while HLG provides better dynamic range and color display performance.

Video Transmission: With DJI's long-range transmission O4 technology, the aircraft can offer a maximum transmission range of 20 km and video quality at up to 1080p 60fps from the aircraft to the DJI Fly app. The remote controller works at 2.4, 5.8, and 5.1 GHz and is capable of selecting the best transmission channel automatically.

Intelligent Flight Modes: With the Advanced Pilot Assistance System (APAS), the aircraft can quickly sense and bypass obstacles in all directions while the user is operating the aircraft for a safer flight and smoother footage. Intelligent Flight Modes such as FocusTrack, MasterShots, QuickShots, Hyperlapse, Waypoint Flight and Cruise Control enable users to capture cinematic videos effortlessly.



- The maximum flight speed was tested at sea level altitude without wind. The maximum flight time was tested in an environment without wind while flying at a consistent flight speed of 13.4 mph (21.6 kph).
- The remote control devices reach their maximum transmission distance (FCC) in a wide open area with no electromagnetic interference at an altitude of about 120 m (400 ft). The maximum transmission distance refers to the maximum distance that the aircraft can still send and receive transmissions. It does not refer to the maximum distance the aircraft can fly in a single flight.
- 5.8 GHz is not supported in some regions, where it will automatically be disabled. Always observe local laws and regulations.
- 5.1 GHz can be used only in countries and regions where it is permitted by local laws and regulations.
- The Intelligent Flight Battery Plus needs to be purchased separately and it is sold only in some countries and regions. Visit the official DJI online store for more information.

- The maximum takeoff weight will be more than 249 g if the aircraft is used with the Intelligent Flight Battery Plus. Make sure to observe local laws and regulations about the takeoff weight.

Using for the First Time



Click the link below or scan the QR code to watch the tutorial video.



<https://s.dji.com/guide66>

Preparing the Aircraft

All aircraft arms are folded before the aircraft is packaged. Follow the steps below to unfold the aircraft.

1. All Intelligent Flight Batteries are in hibernation mode before shipment to ensure safety. Charge to activate the batteries for the first time. Connect the USB charger to the USB-C port on the aircraft to charge. The battery is activated when it begins charging.

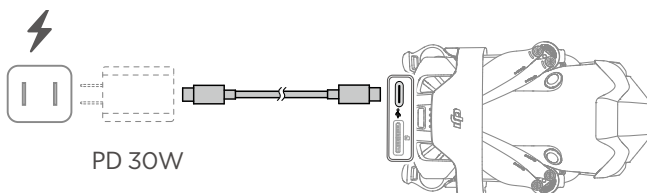

2. Remove the propeller holder.

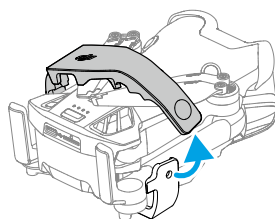

3. Remove the gimbal protector from the camera.

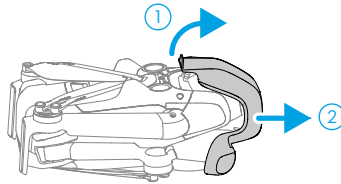

4. Unfold the rear arms, followed by the front arms, and then all of the propeller blades.

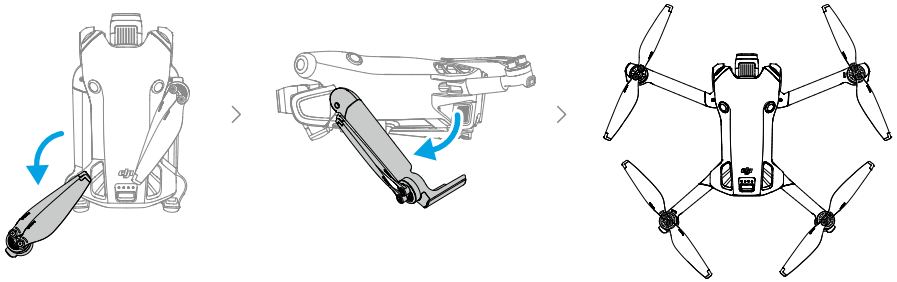

-
- ⚠** • It is recommended to use the DJI 30W USB-C Charger or other USB Power Delivery chargers.
- The maximum charge voltage for the aircraft charging port is 12 V.
 - Make sure the gimbal protector is removed and all arms are unfolded before powering on the aircraft. Otherwise, it may affect the aircraft self-diagnostics.
 - It is recommended to attach the gimbal protector and propeller holder when the aircraft is not in use.
-

Preparing the Remote Controller

DJI RC 2

1. Remove the control sticks from the storage slots and mount them on the remote controller.

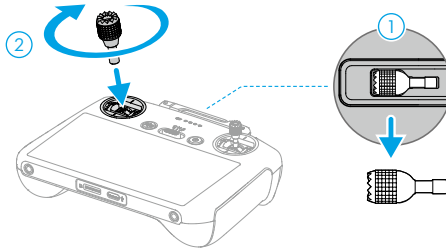

2. Unfold the antennas.

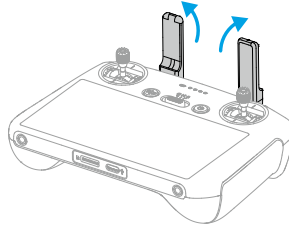

3. The remote controller needs to be activated before first use and an internet connection is required for activation. Press, and then press and hold the power button to power on the remote controller. Follow the on-screen prompts to activate the remote controller.

DJI RC-N2

1. Remove the control sticks from the storage slots and mount them on the remote controller.
2. Pull out the mobile device holder. Choose the appropriate remote controller cable based on the port type of your mobile device (a Lightning connector cable and a USB-C cable are included in the packaging). Place your mobile device in the holder, then connect the end of the cable without the remote controller logo to your mobile device. Make sure your mobile device is securely in place.

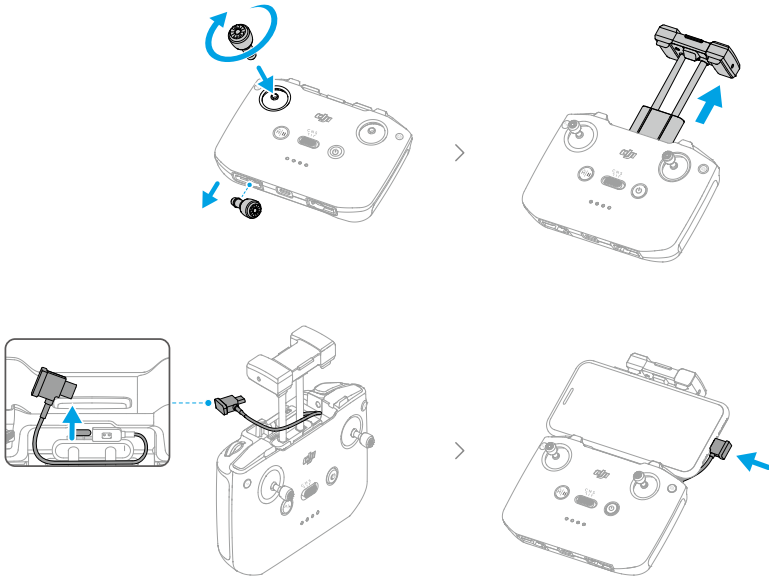

- ⚠** • If a USB connection prompt appears when an Android mobile device is used, select the option to charge only. Other options may cause the connection to fail.

Activating the Aircraft

The aircraft requires activation before first use. Press, and then press and hold the power button to power on the aircraft and remote controller respectively, and then follow the on-screen prompts to activate the aircraft using DJI Fly. An internet connection is required for activation.

Binding the Aircraft and Remote Controller

After activation, the aircraft is bound to the remote controller automatically. If automatic binding fails, follow the on-screen prompts on DJI Fly to bind the aircraft and remote controller for optimal warranty services.

Firmware Update

A prompt will appear in DJI Fly when new firmware is available. Update the firmware whenever prompted to ensure optimal user experience.

Diagram

Aircraft

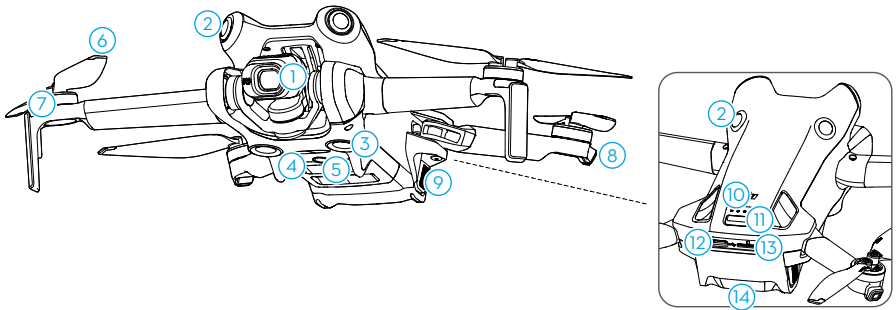

- | | |
|---|--------------------------------|
| 1. Gimbal and Camera | 8. Aircraft Status Indicators |
| 2. Omnidirectional Vision System ^[1] | 9. Battery Buckles |
| 3. Downward Vision System | 10. Battery Level LEDs |
| 4. 3D Infrared Sensing System | 11. Power Button |
| 5. Auxiliary Light | 12. USB-C Port |
| 6. Propellers | 13. microSD Card Slot |
| 7. Motors | 14. Intelligent Flight Battery |

[1] The omnidirectional vision system can sense obstacles in horizontal directions and above.

DJI RC 2 Remote Controller

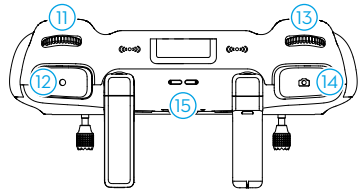
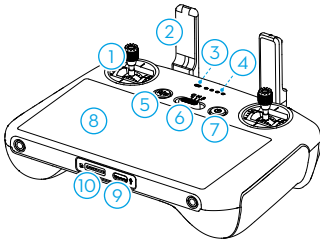

1. Control Sticks

Use the control sticks to control the aircraft movements. Set the control stick mode in DJI Fly. The control sticks are removable and easy to store.

2. Antennas

Transmit aircraft control and video wireless signals.

3. Status LED

Indicates the status of the remote controller.

4. Battery Level LEDs

Displays the current battery level of the remote controller.

5. Flight Pause/Return to Home (RTH) Button

Press once to make the aircraft brake and hover in place (only when GNSS or Vision Systems are available). Press and hold to initiate RTH. Press again to cancel RTH.

6. Flight Mode Switch

For switching between three flight modes: Cine, Normal, and Sport mode.

7. Power Button

Press once to check the current battery level. Press, and then press and hold to power the remote controller on or off. When the remote controller is powered on, press once to turn the touchscreen on or off.

8. Touchscreen

Touch the screen to operate the remote controller. Note that the touchscreen is not waterproof. Operate with caution.

9. USB-C Port

For charging and connecting the remote controller to your computer.

10. microSD Card Slot

For inserting a microSD card.

11. Gimbal Dial

Controls the tilt of the camera.

12. Record Button

Press once to start or stop recording.

13. Camera Control Dial

For zoom control. Set the function in DJI Fly by entering Camera View > Settings > Control > Button Customization.

14. Focus/Shutter Button

Press halfway down on the button to autofocus and press all the way down to take a photo. Press once to switch to photo mode when in record mode.

15. Speaker

Outputs sound.

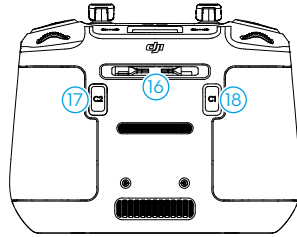

16. Control Sticks Storage Slot

For storing the control sticks.

17. Customizable C2 Button

Switch between Landscape and Portrait mode. Set the function in DJI Fly by entering Camera View > Settings > Control > Button Customization.

18. Customizable C1 Button

Switch between recentring the gimbal and pointing the gimbal downward. Set the function in DJI Fly by entering Camera View > Settings > Control > Button Customization.

DJI RC-N2 Remote Controller

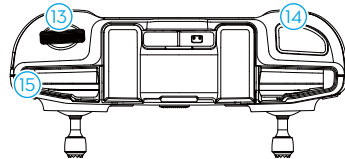
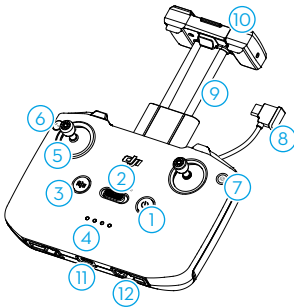

1. Power Button

Press once to check the current battery level. Press, and then press and hold to power the remote controller on or off.

2. Flight Mode Switch

For switching between three flight modes: Cine, Normal, and Sport mode.

3. Flight Pause/Return to Home (RTH) Button

Press once to make the aircraft brake and hover in place (only when GNSS or Vision

Systems are available). Press and hold to initiate RTH. Press again to cancel RTH.

4. Battery Level LEDs

Displays the current battery level of the remote controller.

5. Control Sticks

Use the control sticks to control the aircraft movements. Set the control stick mode in DJI Fly. The control sticks are removable and easy to store.

6. Customizable Buttons

Press once to recenter the gimbal or point the gimbal downward. Press twice to switch between Landscape and Portrait mode. Set the function in DJI Fly by entering Camera View > Settings > Control > Button Customization.

7. Photo/Video Toggle

Press once to switch between photo and video mode.

8. Remote Controller Cable

Connect to a mobile device for video linking via the remote controller cable. Select the cable according to the port type on your mobile device.

9. Mobile Device Holder

For mounting the mobile device securely on the remote controller.

10. Antennas

Transmit aircraft control and video wireless signals.

11. USB-C Port

For charging and connecting the remote controller to your computer.

12. Control Sticks Storage Slot

For storing the control sticks.

13. Gimbal Dial

Controls the tilt of the camera. Press and hold the customizable button to use the gimbal dial for zoom control.

14. Shutter/Record Button

Press once to take a photo or start/stop recording.

15. Mobile Device Slot

For securing the mobile device.

Aircraft

This chapter describes safe flight practices, flight restrictions, basic flight operations, and the intelligent flight modes.

Flight and Safety

After completing the pre-flight preparation, it is recommended to train your flying skills and practice flying safely. Pick a suitable area to fly in according to the following flight requirements and restrictions. Strictly abide by local laws and regulations when flying. Read the Safety Guidelines before flight to ensure the safe use of the product.

Flight Environment Requirements

1. DO NOT operate the aircraft in severe weather conditions including wind speeds exceeding 10.7 m/s, snow, rain, and fog.
2. Only fly in open areas. Tall buildings and large metal structures may affect the accuracy of the onboard compass and GNSS system. Therefore, DO NOT take off from a balcony or anywhere within 10 m of buildings. Keep a distance of at least 10 m from buildings during flight. After takeoff, make sure you are notified with the voice prompt Home Point is updated before continuing flight. If the aircraft has taken off near buildings, the accuracy of the Home Point cannot be guaranteed. In this case, pay close attention to the current position of the aircraft during auto RTH. When the aircraft is close to the Home Point, it is recommended to cancel auto RTH and manually control the aircraft to land at an appropriate location.
3. The performance of the aircraft and its battery is limited when flying at high altitudes. Fly with caution. The maximum takeoff altitude of the aircraft is 4,000 m (13,123 ft) when flying with the Intelligent Flight Battery. If the Intelligent Flight Battery Plus is used, the maximum takeoff altitude drops to 3,000 m (9,843 ft). If a propeller guard is installed on the aircraft with the Intelligent Flight Battery, the maximum takeoff altitude becomes 1,500 m (4,921 ft). DO NOT use the propeller guard together with the Intelligent Flight Battery Plus.
4. The braking distance of the aircraft is affected by the flight altitude. The higher the altitude, the greater the braking distance. When flying at an altitude above 3,000 m (9,843 ft), the user should reserve at least 20 m of vertical braking distance and 25 m of horizontal braking distance to ensure flight safety.
5. Avoid obstacles, crowds, trees, and bodies of water (recommended height is at least 3 m above water).
6. Minimize interference by avoiding areas with high levels of electromagnetism, such as locations near power lines, base stations, electrical substations, and broadcasting towers.
7. GNSS cannot be used on the aircraft in polar regions. Use the vision system instead.
8. DO NOT take off from moving objects such as cars, ships, and airplanes.
9. DO NOT take off from solid-colored surfaces or surfaces with strong reflection such as a car roof.
10. DO NOT use the aircraft, remote controller, battery, battery charger, and the battery charging hub near accidents, fire, explosions, floods, tsunamis, avalanches, landslides, earthquakes, dust, sandstorms, salt spray, or fungus.
11. Operate the aircraft, remote controller, battery, battery charger, and the battery charging hub in a dry environment.
12. DO NOT operate the aircraft in an environment at risk of a fire or explosion.
13. DO NOT operate the aircraft near bird flocks.

Operating the Aircraft Responsibly

To avoid serious injury and property damage, observe the following rules:

1. Make sure you are NOT under the influence of anesthesia, alcohol, or drugs or suffering from dizziness, fatigue, nausea, or other conditions that could impair the ability to operate the aircraft safely.
2. When landing, power off the aircraft first, then switch off the remote controller.
3. DO NOT drop, launch, fire, or otherwise project any dangerous payloads on or at any buildings, persons, or animals, which could cause personal injury or property damage.
4. DO NOT use an aircraft that has been crashed or accidentally damaged or an aircraft that is not in good condition.
5. Make sure to train sufficiently and have contingency plans for emergencies or when an incident occurs.
6. Make sure to have a flight plan. DO NOT fly the aircraft recklessly.
7. Respect the privacy of others when using the camera. Make sure to comply with local privacy laws, regulations, and moral standards.
8. DO NOT use this product for any reason other than general personal use.
9. DO NOT use it for illegal or inappropriate purposes such as spying, military operations, or unauthorized investigations.
10. DO NOT use this product to defame, abuse, harass, stalk, threaten, or otherwise violate legal rights such as the right to privacy and publicity of others.
11. DO NOT trespass onto the private property of others.

Flight Restrictions

GEO (Geospatial Environment Online) System

DJI's Geospatial Environment Online (GEO) System is a global information system that provides real-time information on flight safety and restriction updates and prevents UAVs from flying in restricted airspace. Under exceptional circumstances, restricted areas can be unlocked to allow flights in. Prior to that, the user must submit an unlocking request based on the current restriction level in the intended flight area. The GEO system may not fully comply with local laws and regulations. Users shall be responsible for their own flight safety and must consult with the local authorities on the relevant legal and regulatory requirements before requesting to unlock a flight in a restricted area. For more information about the GEO system, visit <https://fly-safe.dji.com>.

Flight Limits

For safety reasons, flight limits are enabled by default to help users operate this aircraft safely. Users can set flight limits on height and distance. Altitude limits, distance limits, and GEO zones function concurrently to manage flight safety when GNSS is available. Only altitude can be limited when GNSS is unavailable.

Flight Altitude and Distance Limits

Max altitude restricts an aircraft’s flight altitude, while max distance restricts an aircraft’s flight radius around the Home Point. These limits can be changed in the DJI Fly app for improved flight safety.

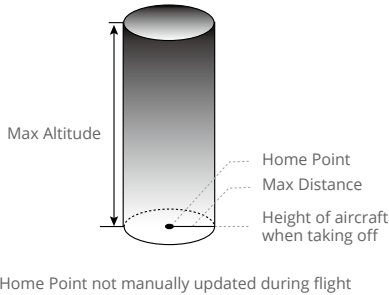

Strong GNSS Signal

	Flight Restrictions	Prompt in DJI Fly App
Max Altitude	Altitude of the aircraft cannot exceed the value set in DJI Fly.	Max flight altitude reached.
Max Distance	The straight-line distance from the aircraft to the Home Point cannot exceed the max flight distance set in DJI Fly.	Max flight distance reached.

Weak GNSS Signal

	Flight Restrictions	Prompt in DJI Fly App
Max Altitude	<ul style="list-style-type: none"> Altitude is restricted to 30 m from the takeoff point if lighting is sufficient. Altitude is restricted to 2 m above the ground if lighting is not sufficient and the 3D infrared sensing system is operating. Altitude is restricted to 30 m from the takeoff point if lighting is not sufficient and the 3D infrared sensing system is not operating. 	Max flight altitude reached.
Max Distance	No limits	

- ⚠ • Each time the aircraft is powered on, the altitude limit of 2 m or 30 m will be automatically removed as long as the GNSS signal ever becomes strong (GNSS signal strength ≥ 2) once, and the limit will not take effect even if the GNSS signal becomes weak afterwards.
- If the aircraft flies out of the set flight range due to inertia, you can still control the aircraft but cannot fly it any further.
 - For safety reasons, DO NOT fly the aircraft close to airports, highways, railway stations, railway lines, city centers, or other sensitive areas. Only fly the aircraft within a visual line of sight.

GEO Zones

DJI's GEO system designates safe flight locations, provides risk levels and safety notices for individual flights and offers information on restricted airspace. All restricted flight areas are referred to as GEO Zones, which are further divided into Restricted Zones, Authorization Zones, Warning Zones, Enhanced Warning Zones, and Altitude Zones. Users can view such information in real-time in DJI Fly. GEO Zones are specific flight areas, including but not limited to airports, large event venues, locations where public emergencies have occurred (such as forest fires), nuclear power plants, prisons, government properties, and military facilities. By default, the GEO system limits takeoffs and flights in zones that may cause safety or security concerns. A GEO Zone map that contains comprehensive information on GEO Zones around the globe is available on the official DJI website: <https://fly-safe.dji.com/nfz/nfz-query>.

Unlocking GEO Zones

To satisfy the needs of different users, DJI provides two unlocking modes: Self-Unlocking and Custom Unlocking. Users may request on the DJI Fly Safe website.

Self-Unlocking is intended for unlocking Authorization Zones. To complete Self-Unlocking, the user must submit an unlocking request via the DJI Fly Safe website at <https://fly-safe.dji.com>. Once the unlocking request is approved, the user may synchronize the unlocking license through the DJI Fly app. To unlock the zone, alternatively, the user may launch or fly the aircraft directly into the approved Authorization Zone and follow the prompts in DJI Fly to unlock the zone.

Custom Unlocking is tailored for users with special requirements. It designates user-defined custom flight areas and provides flight permission documents specific to the needs of different users. This unlocking option is available in all countries and regions and can be requested via the DJI Fly Safe website at <https://fly-safe.dji.com>.

-
-  • To ensure flight safety, the aircraft will not be able to fly out of the unlocked zone after entering it. If the Home Point is outside the unlocked zone, the aircraft will not be able to return home.
-

Pre-Flight Checklist

1. Make sure the propeller holder and the gimbal protector is removed.
2. Make sure the Intelligent Flight Battery and the propellers are mounted securely.
3. Make sure the remote controller, mobile device, and Intelligent Flight Battery are fully charged.
4. Make sure the aircraft arms are unfolded.
5. Make sure the gimbal and camera are functioning normally.
6. Make sure that there is nothing obstructing the motors and that they are functioning normally.
7. Make sure that DJI Fly is successfully connected to the aircraft.
8. Make sure all camera lenses and sensors are clean.

9. Only use genuine DJI parts or DJI authorized parts. Unauthorized parts may cause system malfunctions and compromise flight safety.
10. Make sure the Obstacle Avoidance Action is set in DJI Fly, and the max flight altitude, max flight distance and RTH altitude are all set properly according to the local laws and regulations.

Basic Flight

Auto Takeoff/Landing



Auto Takeoff

Use the Auto Takeoff function:

1. Launch DJI Fly and enter the camera view.
2. Complete all steps in the pre-flight checklist.
3. Tap . If conditions are safe for takeoff, press and hold the button to confirm.
4. The aircraft will take off and hover approximately 1.2 m (3.9 ft) above the ground.

Auto Landing

Use the Auto Landing function:

1. Tap . If conditions are safe to land, press and hold the button to confirm.
2. Auto landing can be canceled by tapping .
3. If the Downward Vision System is working normally, Landing Protection will be enabled.
4. Motors will stop automatically after landing.

 • Choose the proper place for landing.

Starting/Stopping the Motors

Starting the Motors

Perform the Combination Stick Command (CSC) as shown below to start the motors. Once the motors have started spinning, release both sticks simultaneously.

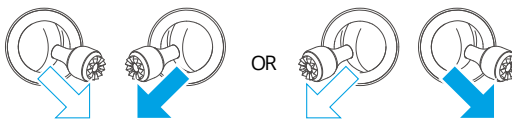

Stopping the Motors

The motors can be stopped in two ways:

Method 1: When the aircraft has landed, push the throttle stick down and hold until the motors stop.

Method 2: When the aircraft has landed, perform the same CSC used to start the motors until the motors stop.



Method 1

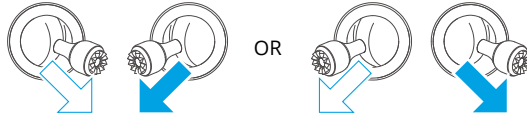

Method 2

Stopping the Motors Mid-Flight

Stopping the motors mid-flight will cause the aircraft to crash. The default setting for Emergency Propeller Stop in the DJI Fly app is Emergency Only, which means that the motors can only be stopped mid-flight when the aircraft detects that it is in an emergency situation such as the aircraft is involved in a collision, a motor has stalled, the aircraft is rolling in the air, or the aircraft is out of control and is ascending or descending very quickly. To stop the motors mid-flight, perform the same CSC that was used to start the motors. Note that the user needs to hold the control sticks for two seconds while performing the CSC to stop the motors. Emergency Propeller Stop can be changed to Anytime in the app by users. Use this option with caution.

Controlling the Aircraft

The control sticks of the remote controller can be used to control the aircraft movements. The control sticks can be operated in Mode 1, Mode 2, or Mode 3, as shown below. The default control mode of the remote controller is Mode 2. Refer to Remote Controller section for more details.

Mode 1

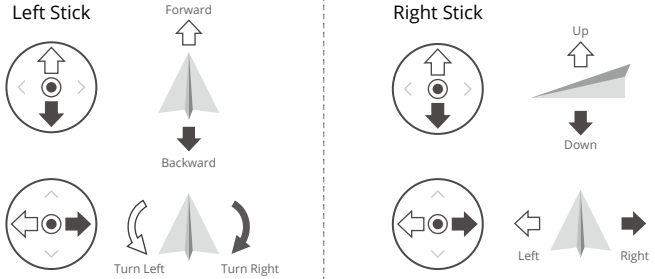

Mode 2

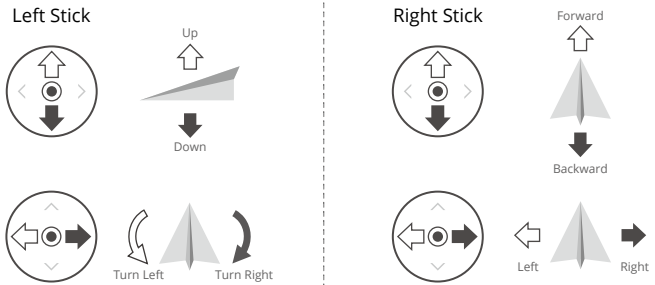

Mode 3

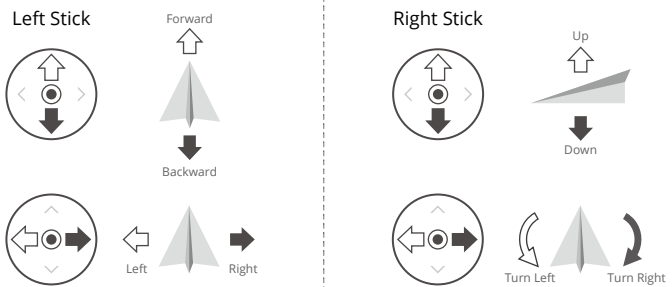

Takeoff/Landing Procedures

1. Place the aircraft in an open, flat area with the rear of the aircraft facing towards the user.
2. Power on the remote controller and the aircraft.
3. Launch DJI Fly and enter the camera view.
4. Tap Settings > Safety, and then set the Obstacle Avoidance Action to Bypass or Brake. Make sure to set an appropriate Max Altitude and RTH Altitude.
5. Wait for the aircraft self-diagnostics to complete. If DJI Fly does not show any irregular warning, you can start the motors.
6. Push the throttle stick up slowly to take off.
7. To land, hover over a level surface and push the throttle stick down to descend.
8. After landing, push the throttle down and hold until the motors stop.
9. Power off the aircraft before the remote controller.

Video Suggestions and Tips

1. The pre-flight checklist is designed to help the user fly safely and shoot videos during flight. Go through the full pre-flight checklist before each flight.
2. Select the desired gimbal operation mode in DJI Fly.
3. It is recommended to take photos or record videos when flying in Normal or Cine mode.
4. DO NOT fly in bad weather such as on rainy or windy days.
5. Choose the camera settings that best suit your needs.
6. Perform flight tests to establish flight routes and preview scenes.
7. Push the control sticks gently to ensure smooth and stable movement of the aircraft.



- Make sure to place the aircraft on a flat and steady surface before takeoff. DO NOT launch the aircraft from your palm or while holding it with your hand.
-

Intelligent Flight Mode

FocusTrack



Click the link below or scan the QR code to watch the tutorial video.



<https://s.dji.com/intelligent-flight>

FocusTrack includes Spotlight, Point of Interest, and ActiveTrack.

- ☀ • Refer to the Controlling the Aircraft section in the Remote Controller chapter for more information about the roll, pitch, throttle, and yaw sticks.
- The aircraft does not automatically take photos or record videos while using FocusTrack. Users need to manually control the aircraft to take photos or record videos.

	Spotlight	Point of Interest (POI)	ActiveTrack
Description	The aircraft does not fly automatically, but the camera remains locked on the subject while the user manually controls the flight.	The aircraft tracks the subject in a circle based on the set radius and flight speed. The max flight speed is 12 m/s and the flight speed may be adjusted dynamically according to the actual radius.	The aircraft keeps a certain distance and altitude from the tracked subject, and there are two modes: Trace and Parallel. The max flight speed is 12 m/s.
Supported Subjects	<ul style="list-style-type: none"> • Stationary subjects • Moving subjects (only vehicles, boats, and people) 		<ul style="list-style-type: none"> • Moving subjects (only vehicles, boats, and people)
Control	Using the control sticks to move the aircraft: <ul style="list-style-type: none"> • Move the roll stick to circle the subject • Move the pitch stick to alter the distance from the subject • Move the throttle stick to change the altitude • Move the yaw stick to adjust the frame 	Using the control sticks to move the aircraft: <ul style="list-style-type: none"> • Move the roll stick to change the circling speed of the aircraft around the subject • Move the pitch stick to alter the distance from the subject • Move the throttle stick to change the altitude • Move the yaw stick to adjust the frame 	Using the control sticks to move the aircraft: <ul style="list-style-type: none"> • Move the roll stick to circle the subject • Move the pitch stick to alter the distance from the subject • Move the throttle stick to change the altitude • Move the yaw stick to adjust the frame

Obstacle Avoidance	<p>When the vision systems are working normally, the aircraft will hover if an obstacle is detected, regardless of whether the obstacle avoidance action is set to Bypass or Brake in DJI Fly.</p> <p>Note: obstacle avoidance is disabled in Sport mode.</p>	<p>The aircraft will bypass obstacles regardless of the flight modes or obstacle avoidance action settings in DJI Fly when the vision systems are working normally.</p>
--------------------	---	---

ActiveTrack

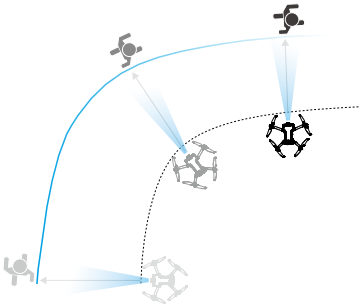
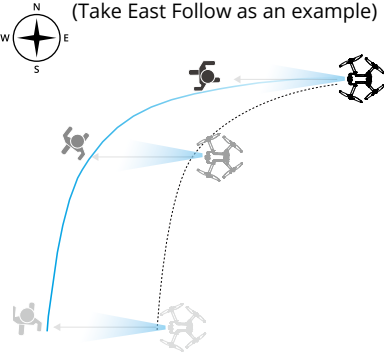
Trace	<p>There are eight types of tracking directions: Front, Back, Left, Right, Front Diagonal Left, Front Diagonal Right, Back Diagonal Left, and Back Diagonal Right. After setting the tracking direction, the aircraft will follow the subject from the tracking direction relative to the direction of the subject movements.</p>	<p>(Take Right Follow as an example)</p> 
Parallel	<p>The aircraft tracks the subject while maintaining the same geographical orientation in relation to the subject.</p>	<p>(Take East Follow as an example)</p> 

⚠ • In Trace mode, the direction setting is only effective when the subject is moving in a stable direction. If the moving direction of the subject is not stable, the aircraft will track the subject from a certain distance and altitude. Once the tracking starts, the direction of tracking can be adjusted through the trace wheel.

In ActiveTrack, the supported follow ranges of the aircraft and subject are as follows:

Subject	People	Vehicles/Boats
Horizontal Distance	4-20 m (Optimal: 4-15 m)	6-100 m (Optimal: 20-50 m)
Altitude	0.5-20 m (Optimal: 2-15 m)	6-100 m (Optimal: 10-50 m)

💡 • When tracking a person, the parameter of the maximum horizontal distance or altitude between the aircraft and the subject can be set to 15 m. In actual flight, the aircraft can break the limit and fly to 20 m by moving the control sticks.

⚠️ • The aircraft will fly to the supported distance and altitude range if the distance and altitude is out of range when ActiveTrack begins. Fly the aircraft at the optimal distance and altitude for the best tracking performance.

Using FocusTrack

1. Launch the aircraft and take off.

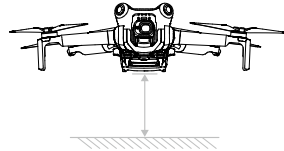

2. Drag-select the subject in the camera view, or enable Subject Scanning under Control settings in DJI Fly and tap the recognized subject to enable FocusTrack.

💡 • FocusTrack must be used within the supported zoom ratio as follows. Otherwise, subject recognition will be affected.

- Spotlight/Point of Interest: supports up to 4x^[1] zoom for moving subjects (only vehicles, boats, and people) and stationary subjects.
- ActiveTrack: supports up to 4x^[1] zoom for moving subjects (only vehicles, boats, and people).

[1] The actual zoom ratio depends on the shooting mode. 12MP Photo: 1-2x, 4K: 1-3x, FHD: 1-4x.

- a. The aircraft enters Spotlight by default and does not fly automatically. The user needs to manually control the flight of the aircraft by using the control sticks. Tap the shutter/record button on the camera view in DJI Fly or press the shutter/record button on the remote controller to start shooting.



- b. Tap on the bottom of the screen to switch to Point of Interest. After setting the flight direction and speed, tap GO and the aircraft will automatically start circling around the subject at the current altitude. The user can also move the control sticks to manually control the flight while the aircraft is automatically flying. Tap the shutter/record button on the camera view in DJI Fly or press the shutter/record button on the remote controller to start shooting.



- c. Tap on the bottom of the screen to switch to ActiveTrack. Select a sub-mode and tap GO, the aircraft will start tracking the subject automatically. The user can also move the control sticks to manually control the flight while the aircraft is automatically flying. Tap the shutter/record button on the camera view in DJI Fly or press the shutter/record button on the remote controller to start shooting.

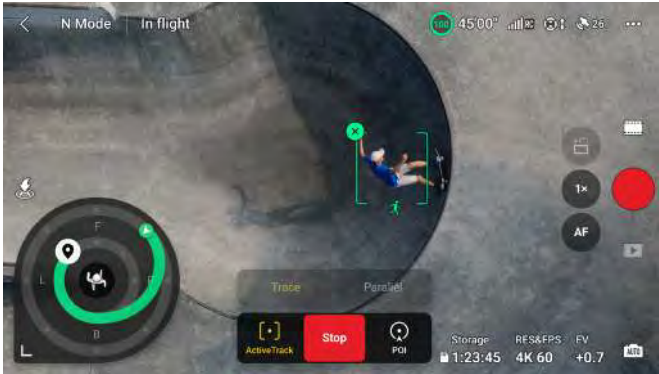

In Trace mode, there will be a trace wheel in the camera view. The dots on the trace wheel indicate different tracking directions. The tracking direction can be changed by tapping the dots or dragging the tracking direction icon to any other dot on the trace wheel. The aircraft will fly to the selected tracking direction based on the green flight route shown on the trace wheel. The aircraft's current position, end position/tracking direction, and flight route can be viewed on the trace wheel. The tracking direction can be adjusted while tracking to fit your needs.

- 💡 • If the tracking subject is a person, the trace wheel in the bottom left corner of the camera view displays the inner and outer circles. If the tracking subject is a vehicle, the trace wheel displays only one circle.

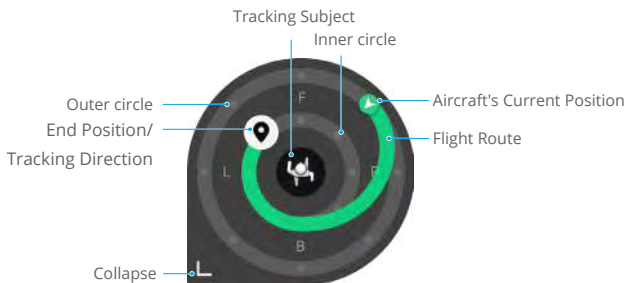

Set the parameters by entering Settings > Control > FocusTrack Settings.

Inner/Outer Radius ^[1]	Set the horizontal distance between the aircraft and the subject when tracking in the inner/outer circle.
Inner/Outer Height ^[1]	Set the vertical distance between the aircraft and the subject when tracking in the inner/outer circle.
Camera Motion	Select Normal or Fast. Normal: Aircraft bypasses obstacles with more subtle attitude changes and maintains smooth flight. Fast: Aircraft bypasses obstacles with greater attitude changes and maneuvers more dynamically.
Near-Ground Flight ^[1]	If enabled, the aircraft's height can be set to below 2 m when tracking. This will increase the risk of colliding with near-ground obstacles will increase. Fly with caution.
Reset FocusTrack Settings	FocusTrack settings for all subjects will be reset to default.

[1] This setting only appears when the tracking subject is a person. During tracking, the user can control the tracking distance and height of the aircraft by using the pitch and throttle sticks. After moving the control sticks, the parameters of the inner/outer circle where the end position/tracking direction  is located will also be adjusted accordingly when tracking. Note that the parameters for the inner and outer circles in the FocusTrack Settings will not be changed.

Exiting FocusTrack

In Point of Interest or ActiveTrack, press the Flight Pause button once on the remote controller or tap Stop on the screen to return to Spotlight.

In Spotlight, press the Flight Pause button once on the remote controller to exit FocusTrack.

After exiting FocusTrack, tap  to view the footage in Playback.



- The aircraft cannot avoid moving subjects such as people, animals, or vehicles. When using FocusTrack, pay attention to the surrounding environment to ensure flight safety.
- DO NOT use FocusTrack in areas with small or fine objects (e.g., tree branches or power lines), transparent objects (e.g., water or glass), or monochrome surfaces (e.g., white walls).
- Always be prepared to press the Flight Pause button on the remote controller or tap Stop in DJI Fly in order to operate the aircraft manually in case any emergency situation occurs.
- Be extra vigilant when using FocusTrack in any of the following situations:
 - a. The tracked subject is not moving on a level plane.
 - b. The tracked subject changes shape drastically while moving.
 - c. The tracked subject is out of sight for an extended period.
 - d. The tracked subject is moving on a snowy surface.
 - e. The tracked subject has a similar color or pattern to its surrounding environment.
 - f. The lighting is extremely dark (<300 lux) or bright (>10,000 lux).
- Make sure to follow local privacy laws and regulations when using FocusTrack.

- It is recommended to only track vehicles, boats, and people (but not children). Fly with caution when tracking other subjects.
 - For the supported moving subjects, vehicles refer to cars and small to medium-sized boats. DO NOT track a remotely controlled model car or boat.
 - The tracking subject may be inadvertently swapped to another subject if they pass nearby each other.
 - In Photo mode, FocusTrack is only available when using Single.
 - FocusTrack is unavailable in the Night video mode.
 - ActiveTrack is unavailable when lighting is insufficient and the vision systems are unavailable. Spotlight and POI for static subjects can still be used, but obstacle sensing is not available.
 - FocusTrack is unavailable when the aircraft is on the ground.
 - FocusTrack may not function properly when the aircraft is flying near flight limits or in a GEO Zone.
 - If the subject is obstructed and it is lost by the aircraft, the aircraft will keep flying at the current speed and orientation for 8 seconds to try and re-identify the subject. If the aircraft fails to re-identify the subject in 10 seconds, it will exit ActiveTrack automatically.
-

MasterShots



Click the link below or scan the QR code to watch the tutorial video.



<https://s.dji.com/intelligent-flight>

MasterShots keeps the subject at the center of the frame while executing different maneuvers in sequence to generate a short cinematic video.

Using MasterShots

1. Launch the aircraft and make it hover at least 2 m (6.6 ft) above ground.

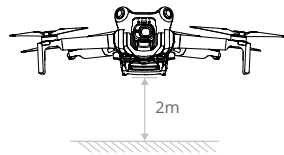

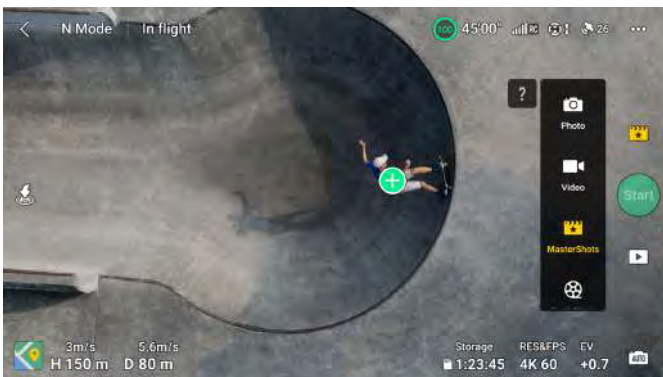

2. In DJI Fly, tap the shooting mode icon to select MasterShots and read the instructions. Make sure you understand how to use the shooting mode and there are no obstacles in the surrounding area.
3. Drag-select the subject in the camera view, and set the flight range. Enter the map view to check the estimated flight range and flight paths, and ensure there is no obstacle in the flight range, such as high buildings. Tap Start, the aircraft will start flying and recording automatically. The aircraft will fly back to its original position once recording is finished.



4. Tap to access, edit, or share the video to social media.

Exiting MasterShots

Press the Flight Pause button once or tap  in DJI Fly to exit MasterShots. The aircraft will brake and hover.

-  • Use MasterShots at locations that are clear of buildings and other obstacles. Make sure there are no humans, animals, or other obstacles in the flight path. When the lighting is sufficient and the environment is suitable for vision systems, the aircraft will brake and hover in place if there is an obstacle detected.
- Always pay attention to objects around the aircraft and use the remote controller to avoid collisions or the aircraft getting obstructed.
- DO NOT use MasterShots in any of the following situations:
 - a. When the subject is blocked for an extended period or outside the line of sight.
 - b. When the subject is similar in color or pattern with the surroundings.
 - c. When the subject is in the air.
 - d. When the subject is moving fast.
 - e. The lighting is extremely dark (<300 lux) or bright (>10,000 lux).
- DO NOT use MasterShots in places close to buildings or where the GNSS signal is weak. Otherwise, the flight path may become unstable.
- Make sure to follow local privacy laws and regulations when using MasterShots.

QuickShots









Click the link below or scan the QR code to watch the tutorial video.



<https://s.dji.com/intelligent-flight>

QuickShots shooting modes include Dronie, Rocket, Circle, Helix, Boomerang, and Asteroid. The aircraft records according to the selected shooting mode and automatically generates a short video. The video can be viewed, edited, or shared to social media from playback.

-  **Dronie:** The aircraft flies backward and ascends with the camera locked on the subject.
-  **Rocket:** The aircraft ascends with the camera pointing downward.
-  **Circle:** The aircraft circles around the subject.
-  **Helix:** The aircraft ascends and spirals around the subject.
-  **Boomerang:** The aircraft flies around the subject in an oval path, ascending as it flies away from its starting point and descending as it flies back. The starting point of the aircraft forms one end of the long axis of the oval, while the other end is at the opposite side of the subject from the starting point.

 **Asteroid:** The aircraft flies backward and upward, takes several photos, and then flies back to the starting point. The video generated starts with a panorama of the highest position and then shows the view from the aircraft as it descends.

-  • Make sure there is sufficient space when using Boomerang. Allow a radius of at least 30 m (99 ft) around the aircraft and a space of at least 10 m (33 ft) above the aircraft.
- Make sure there is sufficient space when using Asteroid. Allow at least 40 m (131 ft) behind and 50 m (164 ft) above the aircraft.

Using QuickShots

1. Launch the aircraft and make it hover at least 2 m (6.6 ft) above ground.

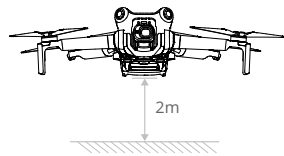

2. In DJI Fly, tap the shooting mode icon to select QuickShots and follow the prompts. Make sure you understand how to use the shooting mode and there are no obstacles in the surrounding area.
3. Choose a sub-mode, drag-select the subject in the camera view. Tap Start, the aircraft will start flying and recording automatically. The aircraft will fly back to its original position once recording is finished.

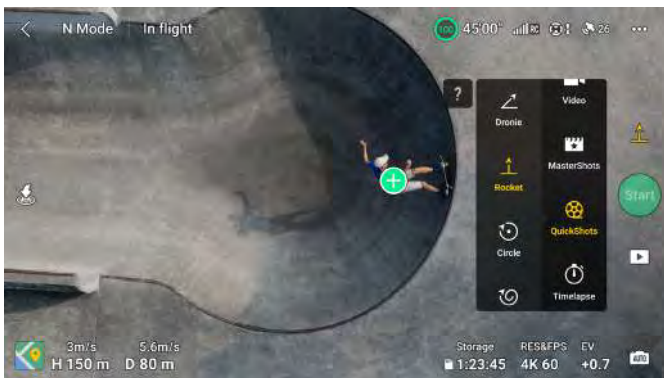

4. Tap  to access, edit, or share the video to social media.

Exiting QuickShots

Press the Flight Pause button once or tap  in DJI Fly to exit QuickShots. The aircraft will brake and hover. Tap the screen again and the aircraft will continue shooting.

Note: if you accidentally move a control stick, the aircraft will exit QuickShots and hover in place.

- ⚠ • Use QuickShots at locations that are clear of buildings and other obstacles. Make sure there are no people, animals, or other obstacles in the flight path. The aircraft will brake and hover in place if there is an obstacle detected.
- Always pay attention to objects around the aircraft and use the remote controller to avoid collisions or the aircraft getting obstructed.
- DO NOT use QuickShots in any of the following situations:
 - a. When the subject is blocked for an extended period or outside the line of sight.
 - b. When the subject is more than 50 m away from the aircraft.
 - c. When the subject is similar in color or pattern with the surroundings.
 - d. When the subject is in the air.
 - e. When the subject is moving fast.
 - f. The lighting is extremely dark (<300 lux) or bright (>10,000 lux).
- DO NOT use QuickShots in places close to buildings or where the GNSS signal is weak. Otherwise, the flight path will become unstable.
- Make sure to follow local privacy laws and regulations when using QuickShots.

Hyperlapse



Click the link below or scan the QR code to watch the tutorial video.



<https://s.dji.com/intelligent-flight>

Hyperlapse shooting modes include Free, Circle, Course Lock, and Waypoint.

- 💡 • After selecting the Hyperlapse shooting mode, go to Settings > Camera > Hyperlapse in DJI Fly to select the photo type of the original hyperlapse photos to be saved, or select Off to not save any original hyperlapse photos. It is recommended to store the footage in the microSD card of the aircraft.
- ⚠ • For optimal performance, it is recommended to use Hyperlapse at an altitude higher than 50 m and set a difference of at least two seconds between the interval time and shutter speed.
- It is recommended to select a static subject (e.g., high-rise buildings, mountainous terrain) located at a safe distance from the aircraft (further than 15 m). DO NOT select a subject that is too close to the aircraft or people or a moving car, etc.

- ⚠ • When the lighting is sufficient and the environment is suitable for vision systems, the aircraft will brake and hover in place if an obstacle is detected during Hyperlapse. If the lighting becomes insufficient or the environment is unsuitable for the vision systems to operate during Hyperlapse, the aircraft will continue shooting without obstacle sensing. Fly with caution.
- The aircraft will only generate a video after at least 25 photos have been taken, which is the amount required to generate a one-second video. The video will be generated by default regardless of whether Hyperlapse concludes normally or the aircraft exits from the mode unexpectedly (such as when Low Battery RTH is triggered).

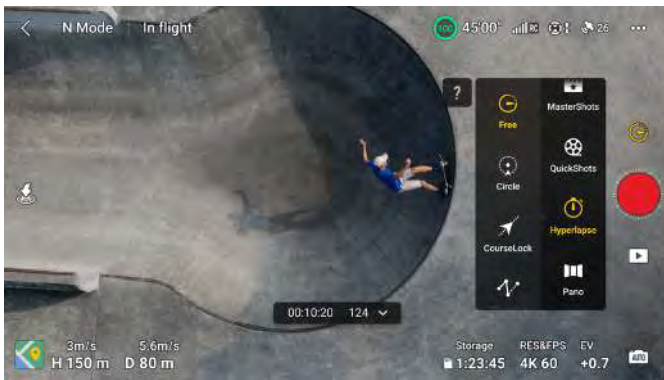

Free

The aircraft automatically takes photos and generates a timelapse video.

Free mode can be used while the aircraft is on the ground.

After takeoff, the aircraft's movements and gimbal tilt can be controlled. Drag-select a subject on the screen, the aircraft will move around the subject when moving the control sticks manually.

Follow the steps below to use Free:

1. Set the interval time, video length, and max speed. The screen displays the number of photos that will be taken and the shooting duration.
2. Tap the shutter/record button to begin.

Circle

The aircraft automatically takes photos while flying around the selected subject to generate a timelapse video. During flight, move the roll stick to adjust the circling speed of the aircraft around the subject, the throttle stick to adjust the altitude, and the pitch stick to adjust the distance from the subject.

Follow the steps below to use Circle:

1. Set the interval time, video length, speed, and circle direction. The screen displays the number of photos that will be taken and the shooting duration.
2. Drag-select a subject on the screen. Use the yaw stick and gimbal dial to adjust the frame.
3. Tap the shutter/record button to begin.

Course Lock

Course Lock allows the user to lock the flight direction. While doing so, the user may select a subject for the camera to point toward while taking hyperlapse photos.

During flight, move the roll stick to adjust the flight path horizontally, the throttle stick to adjust the altitude, and the pitch stick to adjust the flight speed.

If there is only flight direction locked and no subject is selected, then the aircraft orientation and gimbal tilt can be adjusted.

Follow the steps below to use Course Lock:

1. Adjust the aircraft to the desired orientation, and then tap  to lock the current orientation as the flight direction.
2. Set the interval time, video length, and speed. The screen displays the number of photos that will be taken and the shooting duration.
3. If applicable, drag-select a subject. After selecting the subject, the aircraft will automatically adjust the orientation or gimbal angle to center the subject in the camera view. At this time, the frame cannot be adjusted manually.
4. Tap the shutter/record button to begin.

Waypoints

The aircraft automatically takes photos on a flight path of multiple waypoints and generates a timelapse video. The aircraft can fly in sequence from the first waypoint to the final waypoint or in reverse order. The aircraft will not respond to the remote controller stick movements during flight.

Follow the steps below to use Waypoints:

1. Set the desired waypoints. Fly the aircraft to the desired locations and adjust the aircraft orientation and the gimbal tilt.
2. Set the shooting order, interval time, and video length. The screen displays the number of photos that will be taken and the shooting duration.
3. Tap the shutter/record button to begin.

The aircraft will generate a timelapse video automatically, which is viewable in playback.

Waypoint Flight



Click the link below or scan the QR code to watch the tutorial video.



<https://s.dji.com/intelligent-flight>

Waypoint Flight enables the aircraft to capture images during a flight according to the waypoint flight route generated by the preset waypoints. Points of Interest (POI) can be linked to the waypoints. The heading will point toward the POI during flight. A waypoint flight route can be saved and repeated.

Using Waypoint Flight

1. Enable Waypoint Flight

Tap  on the left of the camera view in DJI Fly to enable Waypoint Flight.



2. Plan a Waypoint Flight

Tap **•••** on the operation panel to set the parameters for the flight route such as Global Speed, the behavior of End of Flight, On Signal Lost, and Start Point. The settings apply to all waypoints.

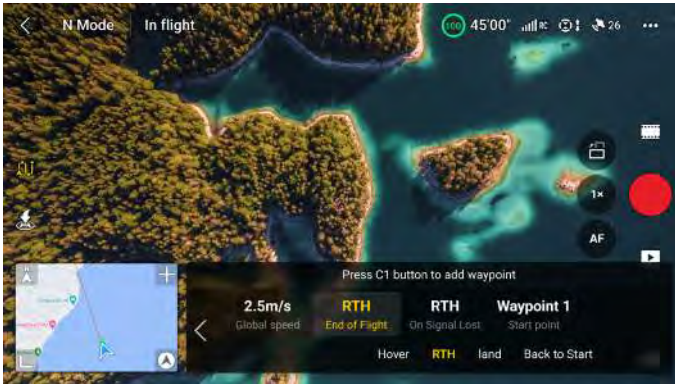

Global Speed	The default flight speed of the entire flight route. Drag the speed bar to set the global speed.
End of Flight	The behavior of the aircraft after the flight task ends. It can be set to Hover, RTH, Land or Back to Start.
On Signal Lost	The behavior of the aircraft when the remote controller signal is lost during flight. It can be set to RTH, Hover, Land or Continue.
Start Point	After selecting the start waypoint, the flight route will be started from this waypoint to the subsequent waypoints.

- 💡 • When using Waypoint Flight in the EU, the behavior of the aircraft when the remote controller signal is lost cannot be set to Continue.

3. Waypoint Settings

a. Pin Waypoint

Waypoints can be pinned via the map before takeoff.

Waypoints can be pinned via the following methods after takeoff, GNSS is required.

- Using the Remote Controller: Press once on the Fn button (RC-N2) or the C1 button (DJI RC 2) to pin a waypoint.
- Using the Operation Panel: Tap **⊞** on the operation panel to pin a waypoint.
- Using the Map: Enter the map view and tap on the map to pin a waypoint.

Press and hold on a waypoint to move its position on the map.

- When pinning a waypoint, it is recommended to fly to the location for a more accurate and smoother imaging result.
 - The aircraft horizontal GNSS position, altitude from the takeoff point, heading, gimbal tilt, and camera zoom ratio at this waypoint will be recorded if the waypoint is pinned during flight via the remote controller or the operation panel.
 - Connect the remote controller to the internet and download the map before using the map to pin a waypoint. When the waypoint is pinned via the map, only the aircraft horizontal GNSS position can be recorded, and the default altitude of the waypoint is set to 50 m from the takeoff point.
- ⚠ The flight route will curve between waypoints, so the aircraft altitude between waypoints may become lower than the altitudes of the waypoints during the flight. Make sure to avoid any obstacles below when setting a waypoint.



b. Settings

Tap the waypoint number for settings, the waypoint parameters are described as follows:



Camera Action	The camera action at the waypoint. Choose between None, Take Photo, and Start or Stop Recording.
Altitude	The altitude at the waypoint from the takeoff point. Make sure to take off at the same takeoff altitude of the original flight to obtain higher accuracy of altitude when a Waypoint Flight is repeated.
Speed	The flight speed from the current waypoint to the next waypoint. <ul style="list-style-type: none"> • Global Speed: the aircraft will fly at the set global speed from the current waypoint to the next waypoint. • Custom: the aircraft will smoothly accelerate or decelerate from the current waypoint to the next waypoint, and reach the custom speed during the process.
Heading	The aircraft heading at the waypoint. <ul style="list-style-type: none"> • Follow Course: the heading of the aircraft is the same as the horizontal tangent to the flight route. • POI^[1]: tap the POI number to point the aircraft heading toward the specific POI. • Manual: the aircraft heading between the previous waypoint and the current waypoint can be adjusted by the user during a Waypoint Flight. • Custom: drag the bar to adjust the heading. The heading can be previewed in the map view.
Gimbal Tilt	The gimbal tilt at the waypoint. <ul style="list-style-type: none"> • POI^[1]: tap the POI number to point the camera toward the specific POI. • Manual: the gimbal tilt between the previous waypoint and the current waypoint can be adjusted by the user during a Waypoint Flight. • Custom: drag the bar to adjust the tilt of the gimbal.
Zoom	The camera zoom at the waypoint. <ul style="list-style-type: none"> • Digital Zoom (1-4x)^[2]: drag the bar to adjust the zoom ratio. • Manual: the zoom ratio between the previous waypoint and the current waypoint can be adjusted by the user during a Waypoint Flight. • Auto^[3]: the zoom ratio from the previous waypoint to the next waypoint will be adjusted smoothly by the aircraft.
Hovering Time	The duration of the aircraft hovering at the current waypoint.

[1] Before selecting POI for heading or gimbal tilt, make sure there are POIs in the flight route. If a POI is linked to a waypoint, the heading and gimbal tilt of the waypoint will be reset to toward the POI.

[2] The actual zoom ratio depends on the shooting mode. 12MP Photo: 1-2x, 4K: 1-3x, FHD: 1-4x.

[3] The zoom of the Start Point and the End Point cannot be set to Auto.

The currently selected parameter setting (all the settings except camera action) can be applied to all waypoints after selecting Apply to All. Tap  to delete the currently selected waypoint.



4. POI Settings





Tap POI on the operation panel to switch to POI settings. Use the same method to pin a POI as used with a waypoint.

Tap the POI number to set the altitude of the POI and link the POI to waypoints.

Altitude	After setting the altitude of the POI, which is the actual altitude of the subject, the gimbal will adjust the pitch angle to ensure that the camera points toward the POI.
Link Waypoint	Multiple waypoints can be linked to the same POI, and the camera will point toward the POI during the Waypoint Flight.

5. Perform a Waypoint Flight

-  • Check the Obstacle Avoidance settings in Settings > Safety page of DJI Fly before performing a Waypoint Flight. When set to Bypass or Brake, the aircraft will brake and hover in place if an obstacle is detected during the Waypoint Flight. The aircraft cannot sense obstacles if the Obstacle Avoidance Action is disabled. Fly with caution.
 - Observe the environment and ensure there are no obstacles on the route before performing a Waypoint Flight.
 - Make sure to maintain visual line of sight (VLOS) of the aircraft. Always be prepared to press the flight pause button in case any emergency situation occurs.
-
-  • When the remote controller signal is lost during flight, the aircraft will perform the action set in On Signal Lost.
 - When the Waypoint Flight is finished, the aircraft will perform the action set in End of Flight.
-

- Tap Next or  on the operation panel to enter the flight route parameters setting page and check again. Users can change the Start Point if necessary. Tap GO to upload the waypoint flight task. Tap  to cancel the uploading process and return to the flight route parameters setting page.
 - The waypoint flight task will be performed after uploading. The flight duration, waypoints, and distance will be displayed on the camera view. The pitch stick can be used to change the flight speed during a Waypoint Flight.
 - Tap  to pause the Waypoint Flight after the task begins. Tap  to continue the Waypoint Flight. Tap  to stop Waypoint Flight and return to the flight route parameters setting page.
- #### 6. Library

When planning a Waypoint Flight, the task will be generated automatically and saved every minute. Tap  on the left to enter Library and save the task manually.

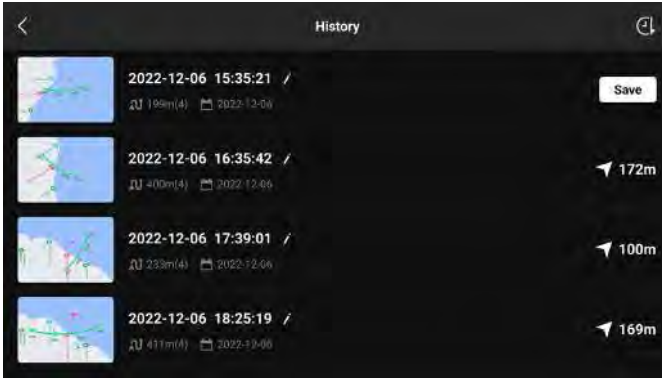

- In the flight route library, you can check the saved tasks, and tap to open or edit a task.
- Tap / to edit the name of the task.
- Slide left to delete a task.
- Tap the icon on the top right corner to change the order the tasks are displayed.
 - 🕒: tasks will be sorted based on the date they were saved.
 - 📏: tasks will be sorted based on the distance between the current position of the remote controller and the start waypoints, from closest to farthest.

7. Exit Waypoint Flight

Tap ⏏ to exit Waypoint Flight. Tap Save and Exit to save the task to Library and exit.

Cruise Control



Click the link below or scan the QR code to watch the tutorial video.



<https://s.dji.com/intelligent-flight>

The cruise control function enables the aircraft to lock the current control stick input of the remote controller when conditions permit, and to automatically fly at the speed corresponding to the current control stick input. Without the need to continually move the control sticks, long-distance flights become more effortless, and image shaking which often happens during manual operating can be avoided. More camera movements such as spiraling up can be achieved by increasing the control stick input.

Using Cruise Control

1. Set the Cruise Control Button

Go to DJI Fly, select Settings > Control > Button Customization, and then set the customizable button of the remote controller to Cruise Control.

2. Enter Cruise Control

- Press the cruise control button while pushing the control stick(s), then the aircraft will fly at the current speed according to the control stick input. The control stick(s) can be released and will automatically return to the center.
- Before the control stick(s) returns to the center, press the cruise control button again to reset the flight speed based on the current control stick input.
- Push the control stick(s) after returning to the center, the aircraft will fly at the updated speed based on the previous speed. In this case, press the cruise control button again, and the aircraft will automatically fly at the updated speed.

3. Exit Cruise Control

Press the cruise control button without a control stick input, press the flight pause button on the remote controller, or tap  on the screen to exit cruise control. The aircraft will brake and hover.



- Cruise control is available when the user is manually operating the aircraft in Normal, Cine, and Sport mode. Cruise control is also available when using APAS, Free Hyperlapse, and Spotlight.
 - Cruise control cannot be started without a control stick input.
 - The aircraft cannot enter or will exit cruise control in the following situations:
 - a. When near the Max Altitude or Max Distance.
 - b. When the aircraft disconnects from the remote controller or DJI Fly.
 - c. When the aircraft senses an obstacle and thus brakes and hovers in place.
 - d. During RTH or auto landing.
 - e. When switching flight modes.
 - The obstacle sensing in cruise control follows the current flight mode. Fly with caution.
-

Aircraft

The aircraft contains a flight controller, video downlink system, vision systems, infrared sensing system, propulsion system, and an Intelligent Flight Battery.

Aircraft

The aircraft contains a flight controller, video downlink system, vision systems, infrared sensing system, propulsion system, and an Intelligent Flight Battery.

Flight Mode

The aircraft supports the following flight modes, which can be switched via the Flight Mode switch on the remote controller.

Normal Mode

The aircraft utilizes GNSS, the omnidirectional vision system, the downward vision system, and the 3D infrared sensing system to locate itself and stabilize. When the GNSS signal is strong, the aircraft uses GNSS to locate itself and stabilize. When the GNSS is weak, but the lighting and other environmental conditions are sufficient, the aircraft uses the vision systems for positioning. When the vision systems are enabled, and lighting and other environmental conditions are sufficient, the maximum pitch angle is 30° and the maximum horizontal speed is 12 m/s.

Sport Mode

In Sport Mode, the aircraft uses GNSS and the downward vision system for positioning, and the aircraft responses are optimized for agility and speed, making it more responsive to control stick movements. The maximum horizontal speed is 16 m/s. Note that obstacle sensing is disabled in Sport Mode.

Cine Mode

Cine mode is based on Normal mode with a limited flight speed, making the aircraft more stable during shooting.

The aircraft automatically changes to Attitude (ATTI) mode when the vision systems are unavailable or disabled and the GNSS signal is weak or the compass experiences interference. In ATTI mode, the aircraft may be more easily affected by its surroundings. Environmental factors such as wind can result in horizontal drift of the aircraft, which may present hazards especially when flying in confined spaces. The aircraft will not be able to hover or brake automatically, therefore the pilot should land the aircraft as soon as possible to avoid accidents.



• The flight modes are only effective for manual flight and cruise control.



- The vision systems are disabled in Sport mode, which means the aircraft cannot sense obstacles on its route automatically. The user must stay alert to the surrounding environment and control the aircraft to avoid obstacles.
- The maximum speed and braking distance of the aircraft significantly increase in Sport mode. A minimum braking distance of 30 m is required in windless conditions.
- A minimum braking distance of 10 m is required in windless conditions while the aircraft is ascending and descending in Sport mode or Normal mode.

- The responsiveness of the aircraft significantly increases in Sport mode, which means a small control stick movement on the remote controller translates into the aircraft moving a large distance. Make sure to maintain adequate maneuvering space during flight.
- The flight speed and attitude are both restricted when the aircraft is flying left or right to ensure shooting stability. The restriction reaches its maximum when the tilt of the gimbal is -90°. If there are strong winds, the restriction will be disabled to improve the wind resistance of the aircraft. As a result, the gimbal may vibrate while shooting.
- Users may experience a minor tremor in videos recorded in Sport mode.

Aircraft Status Indicators

The aircraft has two aircraft status indicators.

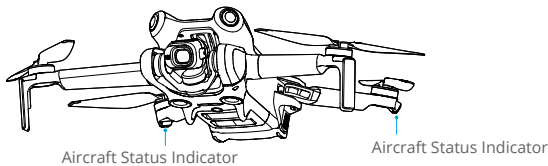

When the aircraft is powered on, but the motors are not running, the aircraft status indicators will display the current status of the flight control system. Refer to the table below for more information about the aircraft status indicators.

Aircraft Status Indicators Descriptions

Normal States

	Blinks red, yellow, and green alternately	Powering on and performing self-diagnostic tests
	Blinks yellow four times	Warming up
	Blinks green slowly	GNSS enabled
	Blinks green twice repeatedly	Vision systems enabled
	Blinks yellow slowly	GNSS and vision systems disabled (ATTI mode enabled)

Warning States

	Blinks yellow quickly	Remote controller signal lost
	Blinks red slowly	Takeoff is disabled, e.g. low battery ^[1]
	Blinks red quickly	Critically low battery
	Solid red	Critical error
	Blinks red and yellow alternately	Compass calibration required

[1] If the aircraft cannot takeoff while the status indicators are blinking red slowly, view the warning prompt in DJI Fly.

After the motors start, the aircraft status indicators will blink green.

 • Lighting requirements vary depending on the region. Observe local laws and regulations.

Return to Home





Click the link below or scan the QR code to watch the tutorial video.



<https://s.dji.com/RTH>

The Return to Home (RTH) function brings the aircraft back to the last recorded Home Point. The RTH can be triggered in three ways: the user actively triggers RTH, the aircraft has low battery, or the control signal between the remote controller and the aircraft is lost. If the aircraft records the Home Point successfully and the positioning system is functioning normally, when the RTH function is triggered, the aircraft will automatically fly back and land at the Home Point.

	GNSS	Descriptions
Home Point		<p>The first location where the aircraft receives a strong to moderately strong GNSS signal (indicated by a white icon) will be recorded as the default Home Point. The Home Point can be updated before takeoff as long as the aircraft receives another strong to moderately strong GNSS signal. If the signal is weak, the Home Point will not be updated. After the Home Point is recorded, DJI Fly will issue a voice prompt.</p> <p>If it is necessary to update the Home Point during a flight (such as where the position of the user has changed), the Home Point can be manually updated in Settings > Safety page in DJI Fly.</p>

During RTH, the aircraft will automatically adjust the gimbal tilt to point the camera toward the RTH route by default. If the video transmission signal is normal, the AR Home Point, AR RTH route, and AR aircraft shadow will be displayed in the camera view by default. This improves the flight experience by helping users view the RTH route and Home Point and avoid obstacles on the route. The display can be changed in System Settings > Safety > AR Settings.

 • The AR RTH route is only used for reference, and may deviate from the actual flight route in different scenarios. Always pay attention to the liveview on the screen during RTH. Fly with caution.

- During RTH, use the gimbal dial to adjust the camera orientation or press the customizable buttons on the remote controller to recenter the camera will stop the aircraft from automatically adjusting the gimbal tilt, which may prevent the AR RTH route from being viewed.
- When reaching the Home Point, the aircraft will automatically adjust the gimbal tilt vertically down.

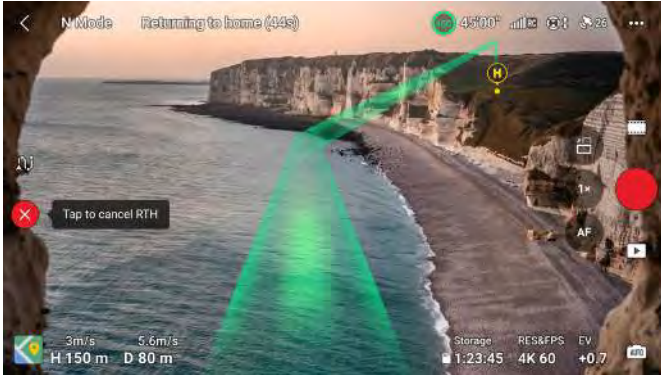

Advanced RTH

When Advanced RTH is triggered, the aircraft will automatically plan the best RTH path, which will be displayed in DJI Fly and will adjust according to the environment.

If the control signal between the remote controller and the aircraft is good, exit RTH by tapping  in DJI Fly or by pressing the RTH button on the remote controller. After exiting RTH, users will regain control of the aircraft.

Trigger Method

• The user actively triggers RTH

Advanced RTH can be initiated either by tapping  in DJI Fly or by pressing and holding the RTH button on the remote controller until it beeps.

• Aircraft low battery

When the Intelligent Flight Battery level is too low and there is not enough power to return home, land the aircraft as soon as possible.

To avoid unnecessary danger caused by insufficient power, the aircraft automatically calculates if the battery power is sufficient to return to the Home Point according to the current position, environment, and flight speed. A warning prompt will appear in DJI Fly when the battery level is low and only enough to complete an RTH flight. The aircraft will automatically fly to the Home Point if no action is taken after a countdown.

The user can cancel RTH by pressing the RTH button on the remote controller. If RTH is canceled following the warning, the Intelligent Battery may not have enough power for the aircraft to land safely, which may lead to the aircraft crashing or being lost.

The aircraft will land automatically if the current battery level can only support the aircraft long enough to descend from its current altitude. Auto landing cannot be canceled, but the remote controller can be used to control the horizontal movement and the descent speed of the aircraft during landing. If there is sufficient power, the throttle stick can be used to make the aircraft ascend at a speed of 1 m/s.

During auto landing, move the aircraft horizontally to find an appropriate place to land as soon as possible. The aircraft will fall if the user keeps pushing the throttle stick upward until the power is depleted.

• **Loss of remote controller signal**

The action of the aircraft when the remote controller signal is lost can be set to RTH, land, or hover in Setting >Safety > Advanced Safety Settings in DJI Fly. If the action is set to RTH, the Home Point was successfully recorded and the compass is functioning normally, Failsafe RTH automatically activates after the remote controller signal is lost for more than six seconds.

When the lighting is sufficient and the environment is suitable for the vision systems to work normally, DJI Fly will display the RTH path that was generated by the aircraft before the remote controller signal was lost. The aircraft will start RTH using Advanced RTH according to the RTH settings. The aircraft will remain in RTH even if the remote controller signal is restored. DJI Fly will update the RTH path accordingly.

When the lighting is not sufficient or the environment is not suitable for the vision systems to work normally, the aircraft will enter Original Route RTH. The aircraft will enter or remain in Preset RTH if the remote controller signal is restored during RTH. The Original Route RTH procedure is as follows:

1. The aircraft brakes and hovers in place.
2. When RTH begins:
 - If the RTH distance (the horizontal distance between the aircraft and the Home Point) is farther than 50 m, the aircraft adjusts its orientation and flies backward for 50 m on its original flight route before entering Preset RTH.
 - If the RTH distance is farther than 5 m but less than 50 m, it adjusts its orientation and flies to the Home Point in a straight line at the current altitude.
 - The aircraft lands immediately if the RTH distance is less than 5 m.
3. The aircraft begins to land when it reaches above the Home Point.

-
-  • If RTH is triggered through DJI Fly and the RTH distance is farther than 5 m, DJI Fly will display the two following options: RTH and Landing. Users can select either RTH or directly land the aircraft.
- The aircraft may not be able to return to the Home Point normally if the positioning system is functioning abnormally. During Failsafe RTH, the aircraft may enter ATTI mode and land automatically if the positioning system is functioning abnormally.
 - It is important to set a suitable RTH altitude before each flight. Launch DJI Fly and set the RTH altitude. The default RTH altitude is 100 m.
 - The aircraft cannot sense obstacles during Failsafe RTH if the vision systems are unavailable.
 - GEO zones may affect the RTH. Avoid flying near GEO zones.

- The aircraft may not be able to return to a Home Point when the wind speed is too high. Fly with caution.
- Pay extra attention to small or fine objects (such as tree branches or power lines) or transparent objects (such as water or glass) during RTH. Exit RTH and control the aircraft manually in an emergency.

RTH Procedure

1. The Home Point is recorded.
2. Advanced RTH is triggered.
3. The aircraft brakes and hovers in place. When RTH begins:
 - The aircraft lands immediately if the RTH distance is less than 5 m.
 - If the RTH distance is farther than 5 m, the aircraft will adjust its orientation to the Home Point and plan the best path according to the RTH settings, lighting, and environmental conditions.
4. The aircraft will fly automatically according to the RTH settings, environment, and transmission signal during RTH.
5. The aircraft lands and the motors stop after reaching the Home Point.

RTH Settings

RTH settings are available for Advanced RTH. Go to the camera view in DJI Fly, tap Settings > Safety, and then RTH.

1. Optimal:



- If the lighting is sufficient and the environment is suitable for the vision systems, the aircraft will automatically plan the optimal RTH path and adjust the altitude according to environmental factors, such as obstacles and transmission signals, regardless of the RTH Altitude setting. The optimal RTH path means the aircraft will travel the shortest distance possible to reduce the amount of battery power used and to increase flight time.
- If the lighting is insufficient or the environment is not suitable for the vision systems, the aircraft will execute Preset RTH based on the RTH Altitude setting.

2. Preset:



Lighting and Environment Conditions		Suitable for Vision Systems	Unsuitable for Vision Systems
RTH distance > 50 m	Current altitude < RTH altitude	The aircraft will plan the RTH path, fly to an open area while bypassing obstacles, ascend to the RTH Altitude, and return to home using the best path.	The aircraft will ascend to the RTH altitude, and fly to the Home Point in a straight line at the RTH altitude.
	Current altitude ≥ RTH altitude	The aircraft will return to home using the best path at the current altitude.	The aircraft will fly to the Home Point in a straight line at the current altitude.
RTH distance is within 5-50 m			

When the aircraft is approaching the Home Point, if the current altitude is higher than the RTH altitude, the aircraft will intelligently decide whether to descend while flying forward according to the surrounding environment, lighting, the set RTH altitude, and the current altitude. When the aircraft reaches above the Home Point, the current altitude of the aircraft will not be lower than the set RTH altitude. **Note that when the lighting is insufficient or the environment is not suitable for the vision systems, the aircraft cannot avoid obstacles. Make sure to set a safe RTH altitude and pay attention to the surrounding environment to ensure flight safety.**

The RTH plans for different environments, RTH trigger methods, and RTH settings are as follows:

Lighting and Environment Conditions	Suitable for Vision Systems	Unsuitable for Vision Systems
		The aircraft can bypass obstacles and GEO zones
The user actively triggers RTH	The aircraft will execute RTH based on the RTH setting: • Optimal • Preset	Preset
Aircraft low battery		
Loss of remote controller signal		Original route RTH, Preset RTH will be executed when the signal is restored

-
- ⚠ • During Advanced RTH, the aircraft will adjust the flight speed automatically to suit environmental factors such as wind speed and obstacles.
- The aircraft cannot avoid small or fine objects such as tree branches or power lines. Fly the aircraft to an open area before using RTH.
 - Set Advanced RTH as Preset if there are power lines or towers that the aircraft cannot bypass on the RTH path and make sure the RTH Altitude is set higher than all obstacles.
 - The aircraft will brake and return to home according to the latest settings if the RTH settings are changed during RTH.
 - If the max altitude is adjusted below the current altitude during RTH, the aircraft will descend to the max altitude first and then continue returning to home.
 - The RTH Altitude cannot be changed during RTH.
 - If there is a large difference between the current altitude and the RTH altitude, the amount of battery power used cannot be calculated accurately due to wind speed difference at different altitudes. Pay extra attention to the battery power prompts and warning prompts in DJI Fly.
 - During Advanced RTH, the aircraft will enter Preset RTH if the lighting condition or environment becomes unsuitable for the vision systems. In this case, the aircraft cannot bypass the obstacles. An appropriate RTH altitude must be set before entering RTH.
 - When the remote controller signal is normal during Advanced RTH, the pitch stick can be used to control the flight speed, but the orientation and altitude cannot be controlled and the aircraft cannot be controlled to fly to the left or right. Constantly pushing the pitch stick to accelerate will increase the battery power consumption speed. The aircraft cannot bypass obstacles if the flight speed exceeds the effective sensing speed. The aircraft will brake and hover in place and exit RTH if the pitch stick is pushed all the way down. The aircraft can be controlled after the pitch stick is released.
 - If the aircraft reaches the altitude limit of the aircraft current location or of the Home Point while it is ascending during Preset RTH, the aircraft stops ascending and returns to the Home Point at the current altitude. Pay attention to flight safety during RTH.
 - If the Home Point is within the Altitude Zone but the aircraft is not, when the aircraft reaches the Altitude Zone it will descend below the altitude limit, which may be lower than the set RTH altitude. Fly with caution.
 - The aircraft will bypass any GEO zones encountered when it is flying forward during Advanced RTH. Fly with caution.
 - The aircraft will exit RTH if the surrounding environment is too complex to complete RTH, even if the vision systems are working properly.
-

Landing Protection

Landing Protection will activate during RTH.

Landing Protection is enabled once the aircraft begins to land.

1. During Landing Protection, the aircraft will automatically detect and carefully land on suitable ground.
2. If the ground is determined unsuitable for landing, the aircraft will hover and wait for pilot confirmation.
3. If Landing Protection is not operational, DJI Fly will display a landing prompt when the aircraft descends to 0.5 m from the ground. Tap confirm or push the throttle stick all the way down and hold for one second, and the aircraft will land.

Precision Landing

The aircraft automatically scans and attempts to match the terrain features below during RTH. The aircraft will land when the current terrain matches the Home Point. A prompt will appear in DJI Fly if the terrain match fails.



- Landing Protection is activated during Precision Landing.
 - The performance of Precision Landing is subject to the following conditions:
 - a. The Home Point must be recorded upon takeoff and must not be changed during flight. Otherwise, the aircraft will have no record of the terrain features of the Home Point.
 - b. During takeoff, the aircraft must ascend at least 7 m before moving horizontally.
 - c. The Home Point terrain features must remain largely unchanged.
 - d. The terrain features of the Home Point must be sufficiently distinctive. Terrain such as a snow-covered field is not suitable.
 - e. The lighting conditions must not be too bright or too dark.
 - The following actions are available during Precision Landing:
 - a. Press the throttle stick down to accelerate landing.
 - b. Movement of any other control stick apart from the throttle stick will be regarded as giving up Precision Landing. The aircraft will descend vertically after the control sticks are released. Landing Protection is still effective in this case.
-

Vision Systems and 3D Infrared Sensing System

DJI Mini 4 Pro is equipped with both an omnidirectional vision system (forward, backward, lateral, upward), downward vision system, and 3D infrared sensing system, which allows for positioning and omnidirectional obstacle sensing.

The omnidirectional vision system consists of four cameras which are located at the front of the aircraft. The downward vision system consists of two cameras, located at the bottom of the aircraft. The vision systems sense obstacles by image ranging.

The 3D infrared sensing system on the bottom consists of a 3D infrared emitter and a receiver. The 3D infrared sensing system helps the aircraft to assess the distance to obstacles, the distance to the ground, and calculate the aircraft position together with the downward vision system. The 3D infrared sensing system meets the human eye safety requirement for Class 1 laser products.

The auxiliary light located at the bottom of the aircraft can assist the downward vision system. It will automatically turn on by default in low-light environments when the flight altitude is under 5 m. Users can also turn it on or off manually in the DJI Fly app. Each time the aircraft is restarted, the auxiliary light will revert back to the default setting Auto.

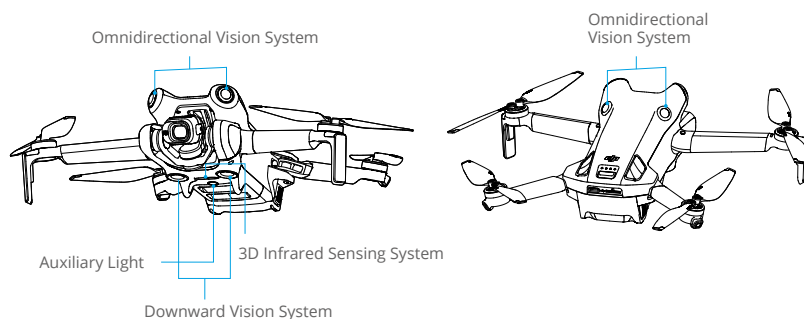

Detection Range

Forward Vision System	Precision Measurement Range: 0.5-18 m; FOV: 90° (horizontal), 72° (vertical)
Backward Vision System	Precision Measurement Range: 0.5-15 m; FOV: 90° (horizontal), 72° (vertical)
Lateral Vision System	Precision Measurement Range: 0.5-12 m; FOV: 90° (horizontal), 72° (vertical)
Upward Vision System^[1]	Precision Measurement Range: 0.5-15 m; FOV: 72° (front and back), 90° (left and right)
Downward Vision System	Precision Measurement Range: 0.3-12 m; FOV: 106° (front and back), 90° (left and right) Hovering Range: 0.5-30 m
3D Infrared Sensing System	Precision Measurement Range: 0.1-8 m (> 10% reflectivity); FOV: 60° (front and back), 60° (left and right)

[1] The omnidirectional vision system can sense obstacles in horizontal directions and above.

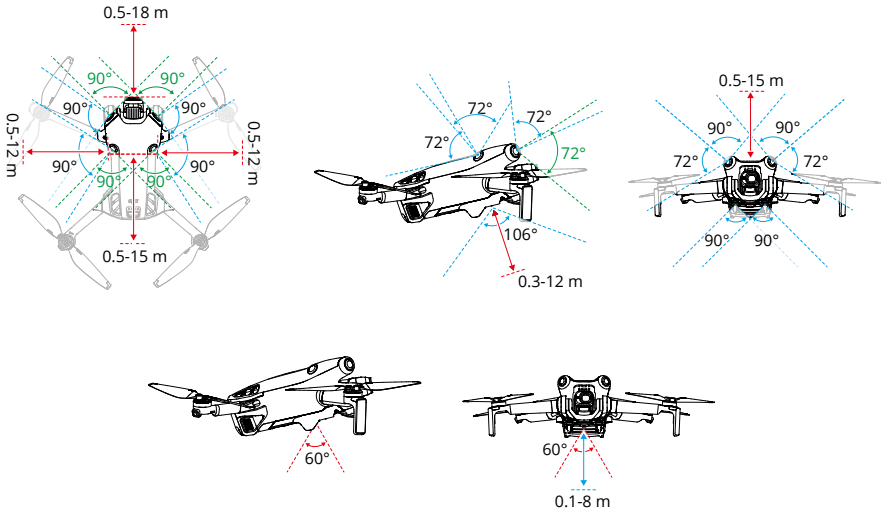

Using the Vision Systems

The positioning function of the downward vision system is applicable when GNSS signals are unavailable or weak. It is automatically enabled in Normal or Cine mode.

The omnidirectional vision system will activate automatically when the aircraft is in Normal or Cine mode and Obstacle Avoidance is set to Bypass or Brake in DJI Fly. The omnidirectional vision system works best with adequate lighting and clearly marked or textured obstacles. Due to inertia, users must make sure to brake the aircraft within a reasonable distance.

- ⚠️ • Pay attention to the flight environment. The vision system and the 3D infrared sensing system only work in certain scenarios and cannot replace human control and judgment. During a flight, always pay attention to the surrounding environment and the warnings in DJI Fly, and be responsible for and maintain control of the aircraft at all times.
- The downward vision system works best when the aircraft is at an altitude from 0.5 to 30 m if there is no GNSS available. Extra caution is required if the altitude of the aircraft is above 30 m as the vision positioning performance may be affected.
- In low-light environments, the vision systems may not achieve optimal positioning performance even if the auxiliary light is turned on. Fly with caution if the GNSS signal is weak in such environments.
- The downward vision system may not work properly when the aircraft is flying near water. Therefore, the aircraft may not be able to actively avoid water below it when landing. It is recommended to maintain flight control at all times, make reasonable judgments based on the surrounding environment, and avoid over-relying on the downward vision system.

- The vision systems cannot accurately identify large structures with frames and cables, such as tower cranes, high-voltage transmission towers, high-voltage transmission lines, cable-stayed bridges, and suspension bridges.
 - The vision systems cannot work properly near surfaces without clear pattern variations or where the light is too weak or too strong. The vision systems cannot work properly in the following situations:
 - a. Flying near monochrome surfaces (e.g., pure black, white, red, or green).
 - b. Flying near highly reflective surfaces.
 - c. Flying near water or transparent surfaces.
 - d. Flying near moving surfaces or objects.
 - e. Flying in an area with frequent and drastic lighting changes.
 - f. Flying near extremely dark (< 10 lux) or bright (> 40,000 lux) surfaces.
 - g. Flying near surfaces that strongly reflect or absorb infrared waves (e.g., mirrors).
 - h. Flying near surfaces without clear patterns or textures.
 - i. Flying near surfaces with repeating identical patterns or textures (e.g., tiles with the same design).
 - j. Flying near obstacles with small surface areas (e.g., tree branches, and power lines).
 - Keep the sensors clean at all times. DO NOT scratch or tamper with the sensors. DO NOT use the aircraft in dusty or humid environments.
 - Vision system cameras may need to be calibrated after being stored for an extended period. A prompt will appear in DJI Fly and calibration will be performed automatically.
 - DO NOT fly when it is rainy, smoggy, or the visibility is lower than 100 m.
 - Check the following each time before takeoff:
 - a. Make sure there are no stickers or any other obstructions over the glass of the infrared sensing system and vision systems.
 - b. Use soft cloth if there is any dirt, dust, or water on the glass of the vision systems and infrared sensing system. DO NOT use any cleaning product that contains alcohol.
 - c. Contact DJI Support if there is any damage to the lenses of the infrared sensing and vision systems.
 - DO NOT obstruct the infrared sensing system and vision systems.
 - The aircraft can fly at any time of the day or night. However, the vision systems become unavailable when flying the aircraft at night. Fly with caution.
-

Advanced Pilot Assistance Systems

The Advanced Pilot Assistance Systems (APAS) feature is available in Normal mode and Cine mode. When APAS is enabled, the aircraft will continue to respond to user commands and plan its path according to both control stick inputs and the flight environment. APAS makes it easier to avoid obstacles, obtain smoother footage, and give a better flying experience.

Keep moving the control sticks in any direction. The aircraft will bypass obstacles by flying above, below, or to the left or right of the obstacle. The aircraft can also respond to the control stick inputs while bypassing obstacles.

When APAS is enabled, the aircraft can be stopped by pressing the Flight Pause button on the remote controller. The aircraft brakes and hovers for three seconds and awaits further pilot commands.

To enable APAS, open DJI Fly, enter Settings > Safety, and enable APAS by selecting Bypass. Select Normal or Nifty mode when using Bypass. In Nifty mode, the aircraft can fly faster, smoother, and closer to obstacles obtaining better footage while bypassing obstacles. However, the risk of crashing into obstacles will increase. Fly with caution.

Nifty mode cannot work normally in the following situations:

1. When aircraft orientation changes rapidly flying near obstacles.
2. When flying through narrow obstacles such as canopies or bushes at high speed.
3. When flying near obstacles that are too small to detect.
4. When flying with the propeller guard.

Landing Protection

Landing Protection will activate if Obstacle Avoidance is set to Bypass or Brake and the user pushes the throttle stick down to land the aircraft. Landing Protection is enabled once the aircraft begins to land.

1. During Landing Protection, the aircraft will automatically detect if an area is suitable for landing, and then land the aircraft.
2. If the ground is determined to be unsuitable for landing, the aircraft will hover when the aircraft descends to 0.8 m above ground. Push down on the throttle stick for at least five seconds, and the aircraft will land without obstacle sensing.





- Make sure to use APAS when the vision systems are available. Make sure there are no people, animals, objects with small surface areas (e.g., tree branches), or transparent objects (e.g., glass or water) along the desired flight path.
- Make sure to use APAS when the downward vision systems are available or the GNSS signal is strong. APAS may not function properly when the aircraft is flying over water or snow-covered areas.
- Be extra cautious when flying in extremely dark (<300 lux) or bright (>10,000 lux) environments.
- Pay attention to DJI Fly and make sure APAS is working normally.
- APAS may not function properly when the aircraft is flying near flight limits or in a GEO zone.

Flight Recorder

Flight data including flight telemetry, aircraft status information, and other parameters are automatically saved to the internal data recorder of the aircraft. The data can be accessed using DJI Assistant 2 (Consumer Drones Series).

Propellers

There are two types of propellers, which are designed to spin in different directions. Marks are used to indicate which propellers should be attached to which motors. Make sure to match the propellers and motors by following the instructions.

Propellers	Marked	Unmarked
Illustration		
Mounting Position	Attach to the motors of the marked arm	Attach to the motors of the unmarked arm

Attaching the propellers

Attach the marked propellers to the motors of the marked arm, and the unmarked propellers to the motors of the unmarked arm. Use the screwdriver from the aircraft package to mount the propellers. Make sure the propellers are secure.

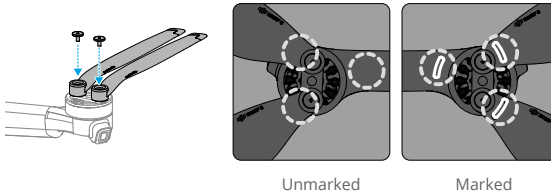

- ⚠ • Make sure to only use the screwdriver from the aircraft package for mounting propellers. Using other screwdrivers may damage the screws.
- Make sure to keep the screws vertical while tightening them. The screws should not be at a tilted angle to the mounting surface. After installation is complete, check whether the screws are flush and rotate the propellers to check for any abnormal resistance.

Detaching the propellers

Use the screwdriver from the aircraft package to loosen the screws and detach the propellers from the motors.

- ⚠ • Propeller blades are sharp. Handle with care.
 - The screwdriver is only for mounting the propellers. DO NOT use the screwdriver to disassemble the aircraft.
 - If a propeller is broken, remove the two propellers and screws on the corresponding motor and discard them. Use two propellers from the same package. DO NOT mix with propellers from other packages.
 - Only use official DJI propellers. DO NOT mix propeller types.
 - Propellers are consumable components. Purchase additional propellers if necessary.
 - Make sure that the propellers and motors are installed securely before each flight. Check to make sure the screws on the propellers are tightened after every 30 hours of flying time (approx. 60 flights).
 - Make sure that all propellers are in good condition before each flight. DO NOT use aged, chipped, or broken propellers.
 - To avoid injury, stay away from rotating propellers or motors.
 - To avoid damaging the propellers, place the aircraft correctly during transportation or storage. DO NOT squeeze or bend the propellers. If propellers are damaged, the flight performance may be affected.
 - Make sure the motors are mounted securely and rotating smoothly. Land the aircraft immediately if a motor is stuck and unable to rotate freely.
 - DO NOT attempt to modify the structure of the motors.
 - DO NOT touch or let hands or body parts come in contact with the motors after flight, as they may be hot.
 - DO NOT block any of the ventilation holes on the motors or the body of the aircraft.
 - Make sure the ESCs sound normal when powered on.
-

Intelligent Flight Battery

DJI Mini 4 Pro Intelligent Flight Battery (BWX140-2590-7.32) is a 7.32V, 2590mAh battery. DJI Mini 3 Pro Intelligent Flight Battery Plus (BWX162-3850-7.38) is a 7.38V, 3850mAh battery. The two batteries have the same structure and dimensions but have a different weight and capacity. Both batteries are equipped with smart charging and discharging functionality.

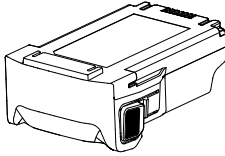

Battery Features

1. **Balanced Charging:** during charging, the voltages of the battery cells are automatically balanced.
2. **Auto-Discharging Function:** to prevent swelling, the battery automatically discharges to 96% battery level when it is idle for three days, and automatically discharges to 60% battery level when it is idle for nine days. Note that it is normal for the battery to emit heat during the discharging process.
3. **Overcharge Protection:** the battery stops charging automatically once fully charged.
4. **Temperature Detection:** to prevent damage, the battery only charges when the temperature is between 5° and 40° C (41° and 104° F). Charging stops automatically if the temperature of the battery cells exceed 55° C (131° F) during charging.
5. **Overcurrent Protection:** the battery stops charging if an excess current is detected.
6. **Over-Discharge Protection:** discharging stops automatically to prevent excess discharge when the battery is not in use. Over-discharge protection is not enabled when the battery is in use.
7. **Short Circuit Protection:** the power supply is automatically cut if a short circuit is detected.
8. **Battery Cell Damage Protection:** the app will display a warning prompt when a damaged battery cell is detected.
9. **Hibernation Mode:** if the battery is less than 10% when the aircraft is idle, the battery enters Hibernation mode to prevent over-discharge. Charge the battery to wake it from hibernation.
10. **Communication:** information about the voltage, capacity, and current of the battery is transmitted to the aircraft.
11. **Maintenance Instructions:** the battery automatically checks the voltage differences between battery cells and decides whether maintenance is required. If maintenance is required, insert the battery into the aircraft and power it on, the aircraft will not be able to take off, and a prompt for maintenance will appear in DJI Fly. If the maintenance prompt appears in DJI Fly, follow the prompt to fully charge the battery and allow the battery to rest for 48 hours. If the battery still does not work after two times of maintenance, contact DJI Support.

 • Refer to the Safety Guidelines and the stickers on the battery before use. Users shall take full responsibility for all operations and usage.



Using the Battery



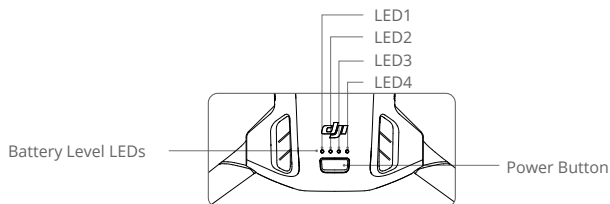





























Checking the Battery Level

Press the power button once to check the current battery level.



 The battery level LEDs display the power level of the battery during charging and discharging. The statuses of the LEDs are defined below:

 LED is on  LED is flashing  LED is off

LED1	LED2	LED3	LED4	Battery Level
				88%-100%
				76%-87%
				63%-75%
				51%-62%
				38%-50%
				26%-37%
				13%-25%
				0%-12%

Powering On/Off

Press the power button once and then press and hold for two seconds to power the aircraft on or off. The battery level LEDs display the battery level when the aircraft is powered on. The battery level LEDs turn off when the aircraft is powered off.

If LEDs 3 and 4 blink simultaneously, this indicates the battery is malfunctioning. Remove the battery from the aircraft, insert the battery again and make sure that it is securely mounted.

Low-Temperature Notice

- Battery capacity is significantly reduced when flying at low temperatures from -10° to 5° C (14° to 41° F). Make sure to fully charge the battery before takeoff. It is recommended to power on the aircraft for a while to warm up the battery. Take off after DJI Fly prompts that the battery is fully warmed up.
- Batteries cannot be used in extremely low-temperature environments of lower than -10° C (14° F).

- To ensure optimal performance, keep the battery temperature above 20° C (68° F).
- The reduced battery capacity in low-temperature environments reduces the wind speed resistance performance of the aircraft. Fly with caution.
- Take extra caution when flying at a high elevation with a low temperature.

Charging the Battery

Fully charge the battery before each use. It is recommended to use the charging devices provided by DJI, such as the DJI Mini 3 Pro Two-Way Charging Hub, DJI 30W USB-C Charger, or other USB Power Delivery chargers. The DJI Mini 3 Pro Two-Way Charging Hub and the DJI 30W USB-C Charger are both optional accessories. Visit the official DJI online store for more information.

- ⚠** • When you charge the battery mounted to the aircraft or inserted into the DJI Mini 3 Pro Two-Way Charging Hub, the maximum charging power supported is 30 W.

Using a Charger

- Ensure the battery has been correctly installed in the aircraft.
- Connect a charger to an AC power supply (100-240 V, 50/60 Hz; use a power adapter if necessary).
- Connect the charger to the charging port on the aircraft using a USB-C cable.
- The battery level LEDs display the current battery level during charging.
- The Intelligent Flight Battery is fully charged when all the battery level LEDs are off. Detach the charger when the battery is fully charged.

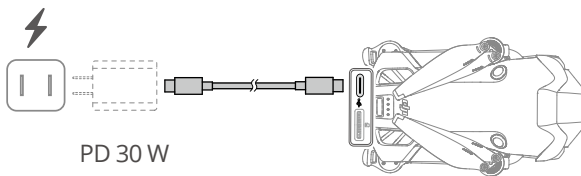

- ⚠** • The battery cannot be charged if the aircraft is powered on.
- The maximum charge voltage for the aircraft charging port is 12 V.
 - DO NOT charge an Intelligent Flight Battery immediately after flight as it may be too hot. Wait for the battery to cool down to the operating temperature before charging again.
 - The charger stops charging the battery if the battery cell temperature is not within the operating range of 5° to 40° C (41° to 104° F). The ideal charging temperature is from 22° to 28° C (71.6° to 82.4° F).
 - Fully charge the battery at least once every three months to maintain battery health.

- 💡 • When using the DJI 30W USB-C Charger, the charging time for Mini 4 Pro Intelligent Flight Battery is approximately 1 hour and 10 minutes, while for Mini 3 Pro Intelligent Flight Battery Plus it is approximately 1 hour and 41 minutes.
- For safety purposes, keep the batteries at a low power level in transit. Before transportation, it is recommended to discharge the batteries to 30% or lower.

The table below shows the battery level during charging.

LED1	LED2	LED3	LED4	Battery Level
				0%-50%
				51%-75%
				76%-99%
				100%

- 💡 • The blinking frequency of the battery level LEDs differs depending on the USB charger used. If the charging speed is fast, the battery level LEDs will blink quickly.
- If the battery is not correctly inserted into the aircraft, LEDs 3 and 4 will blink simultaneously. Insert the battery again and make sure it is securely mounted.
- Four LEDs blinking simultaneously indicates the battery is damaged.

Using the Charging Hub

When used with a USB charger, the DJI Mini 3 Pro Two-Way Charging Hub can charge up to three Intelligent Flight Batteries or Intelligent Flight Batteries Plus in sequence from high to low power level. When used with the DJI 30W USB-C Charger, the charging hub can fully charge one Intelligent Flight Battery in approximately 58 minutes, and one Intelligent Flight Battery Plus in approximately 1 hour and 18 minutes.

When the charging hub is connected to an AC power outlet using a USB charger, users can connect both the Intelligent Flight Batteries and an external device (such as a remote controller or smartphone) to the hub to be charged. The batteries will be charged before the external device by default. When the charging hub is not connected to an AC power outlet, insert the Intelligent Flight Batteries into the hub and connect an external device to the USB port to charge the device, using the charging hub as a power bank. Refer to the DJI Mini 3 Pro Two-Way Charging Hub User Guide for more details.

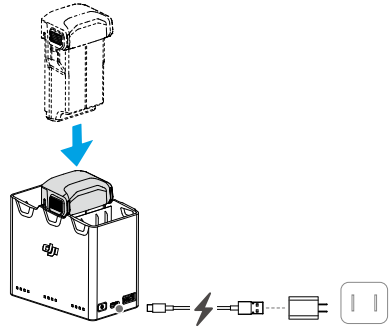
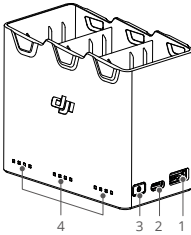

1. USB port
2. Power Port (USB-C)
3. Function Button
4. Status LEDs

How to Charge

1. Insert the batteries into the charging hub until there is a click.
2. Connect the charging hub to a power outlet (100-240 V, 50/60 Hz) using a USB-C cable and a DJI 30W USB-C charger or other USB Power Delivery chargers.
3. The battery with the highest power level will be charged first. The rest will be charged in sequence according to their power levels. The corresponding status LEDs will display the charging status (see table below). After the battery is fully charged, the corresponding LEDs will change to solid green.

Status LED Indicator Descriptions

Charging Status

Blinking Pattern	Descriptions
Status LEDs in an array blink quickly successively	The battery in the corresponding battery port is being charged using a USB PD charger.
Status LEDs in an array blink slowly successively	The battery in the corresponding battery port is being charged using a normal charger.
Status LEDs in an array are solid	The battery in the corresponding battery port is fully charged.
All status LEDs blink in sequence	No battery is inserted.

Battery Level

Each battery port of the charging hub has its corresponding status LED array, from LED1 to LED4 (left to right). Check battery levels by pressing the function button once. The battery level

LED statuses are the same as those on the aircraft. For details, refer to aircraft battery level LEDs statuses and descriptions.

Abnormal Status

The LED status for battery abnormality is the same as that on the aircraft. Refer to the Battery Protection Mechanisms section for details.

- ⚠ • It is recommended to use a DJI 30W USB-C Charger or other USB Power Delivery chargers to power the charging hub.
- The environmental temperature affects the charging speed. Charging is faster in a well-ventilated environment at 25° C (77° F).
- The charging hub is only compatible with BWX140-2590-7.32, BWX162-2453-7.38 Intelligent Flight Battery and BWX162-3850-7.38 Intelligent Flight Battery Plus. DO NOT use the charging hub with other battery models.
- Place the charging hub on a flat and stable surface when in use. Make sure the device is properly insulated to prevent fire hazards.
- DO NOT touch the metal terminals on the battery ports.
- Clean the metal terminals with a clean, dry cloth if there is any noticeable build

Battery Protection Mechanisms

The battery level LEDs can display battery protection notifications triggered by abnormal charging conditions.

Battery Protection Mechanisms					
LED1	LED2	LED3	LED4	Blinking Pattern	Status
				LED2 blinks twice per second	Overcurrent detected
				LED2 blinks three times per second	Short circuit detected
				LED3 blinks twice per second	Overcharge detected
				LED3 blinks three times per second	Over-voltage charger detected
				LED4 blinks twice per second	Charging temperature is too low
				LED4 blinks three times per second	Charging temperature is too high

If any of the battery protection mechanisms are activated, unplug the charger, and plug it in again to resume charging. If the charging temperature is abnormal, wait for it to return to normal. The battery will automatically resume charging without the need to unplug and plug the charger again.

Inserting/Removing the Battery

Insert the Intelligent Flight Battery into the battery compartment of the aircraft. Make sure the battery is fully inserted with a clicking sound, which indicates the battery buckles are securely fastened.

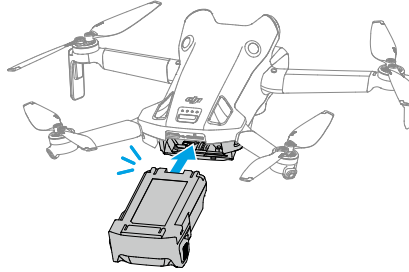

Press the textured part of the battery buckles on the sides of the battery to remove it from the compartment.

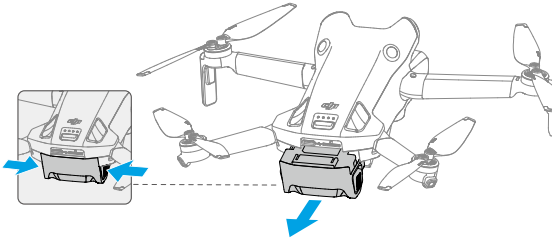

-
- ⚠** • DO NOT insert or remove the battery while the aircraft is powered on.
- Ensure the battery is inserted with a clicking sound. DO NOT launch the aircraft when the battery is not securely mounted, as this may cause poor contact between the battery and the aircraft and present hazards. Make sure the battery is mounted securely.
-

Gimbal and Camera

Gimbal Profile

The 3-axis gimbal stabilizes the camera, allowing you to capture clear and steady images and video at a high flight speed. The gimbal has a control tilt range of -90° to $+60^{\circ}$, and two control roll angles of -90° (portrait) and 0° (landscape).

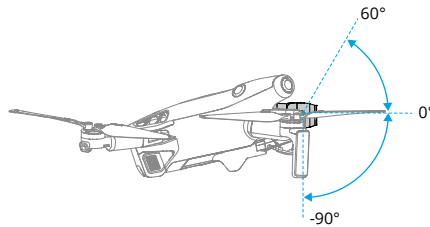

Use the gimbal dial on the remote controller to control the tilt of the gimbal. Alternatively, do so through the camera view in DJI Fly. Press and hold the screen until the gimbal adjustment bar appears. Drag the bar up and down to control the gimbal's tilt.

Tap the Landscape/Portrait Mode Switch in DJI Fly to switch between the two gimbal roll angles. The roll axis will rotate to -90° when Portrait Mode is enabled, and back to 0° in Landscape Mode.

Gimbal Operation Modes

Two gimbal operation modes are available. Switch between the different operation modes in Settings > Control in DJI Fly.

Follow Mode: the angle of the gimbal remains stable relative to the horizontal plane. Users can adjust the gimbal tilt. This mode is suitable for shooting stills.

FPV Mode: when the aircraft is flying forward, the gimbal synchronizes with the movement of the aircraft to provide a first-person flying experience.

-
- ⚠ • Make sure there are no stickers or objects on the gimbal before taking off. DO NOT tap or knock the gimbal after the aircraft is powered on. Launch the aircraft from open and flat ground to protect the gimbal.
 - After installing the wide-angle lens, unfold the arms before powering on the aircraft. Make sure the gimbal is level and pointing forward before takeoff, so that the aircraft can correctly detect the installation status of the wide-angle lens. The gimbal will be level when the aircraft is powered on, if the gimbal rotates, recenter the gimbal using the remote controller or DJI Fly as follows:
 - a. Tap Recenter Gimbal on the Settings > Control page of DJI Fly.
 - b. Press the Fn button on DJI RC-N2 remote controller or the Customizable C1 Button on DJI RC 2 remote controller. The default function is recentering the gimbal or pointing the gimbal downward, which can be customized.
 - Pano and Asteroid functions will not be available after the wide-angle lens is installed.
 - Precision elements in the gimbal may be damaged by a collision or impact, which may cause the gimbal to function abnormally.
 - Avoid getting dust or sand on the gimbal, especially in the gimbal motors.

- A gimbal motor may enter protection mode if the gimbal is obstructed by other objects when the aircraft is put on uneven ground or on grass, or if the gimbal experiences an excessive external force, such as during a collision.
- DO NOT apply external force to the gimbal after the aircraft is powered on.
- DO NOT add any extra payload other than an official accessory to the gimbal, as this may cause the gimbal to function abnormally or even lead to permanent motor damage.
- Remove the gimbal protector before powering on the aircraft. Attach the gimbal protector when the aircraft is not in use.
- Flying in heavy fog or clouds may make the gimbal wet, leading to temporary failure. The gimbal will recover full functionality once it is dry.

Camera Profile

DJI Mini 4 Pro uses a 1/1.3-in CMOS sensor with 48MP effective pixels. The equivalent focal length is approximately 24 mm. The aperture of the camera is F1.7 and shoots from 1 m to infinity.

The DJI Mini 4 Pro camera can take 48MP stills and supports shooting modes such as Single, Burst, AEB, Timed Shot, and Panorama. It also supports H.264/H.265 video recording, digital zoom, and slow motion recording. 4K 60fps HDR and 4K 100fps videos are also supported.



- DO NOT expose the camera lens in an environment with laser beams, such as a laser show, or point the camera at intense light sources for an extended period, such as the sun on a clear day, in order to avoid damaging the sensor.
- Make sure the temperature and humidity are suitable for the camera during use and storage.
- Use a lens cleanser to clean the lens to avoid damage or poor image quality.
- DO NOT block any ventilation holes on the camera as the heat generated may damage the device and injure the user.
- The cameras may not focus correctly in the following situations:
 - a. Shooting dark objects far away.
 - b. Shooting objects with repeating identical patterns and textures or objects without clear patterns or textures.
 - c. Shooting shiny or reflective objects (such as street lighting and glass).
 - d. Shooting flashing objects.
 - e. Shooting fast-moving objects.
 - f. When the aircraft/gimbal is moving fast.
 - g. Shooting objects with varying distances in the focus range.
- DJI Mini 4 Pro uses SmartPhoto mode by default in Single Shot, which integrates features such as scene recognition or HDR for optimal results. SmartPhoto needs to take multiple shots continuously for image synthesis. When the aircraft is moving or using the 48MP resolution, SmartPhoto will not be supported, and the image quality will differ.

Storing and Exporting Photos and Videos

Storing Photos and Videos

DJI Mini 4 Pro supports the use of a microSD card to store your photos and videos. A UHS-I Speed Grade 3 rating or above microSD card is required due to the fast read and write speeds necessary for high-resolution video data. Refer to the Specifications for more information about recommended microSD cards.

Photos and videos can also be saved in the internal storage of the aircraft when no microSD card is available. Use of a microSD card is recommended for large data storage.

Exporting Photos and Videos

- Use QuickTransfer to export the footage to a mobile device.
- Connect the aircraft to a computer using a data cable, export the footage in the internal storage of the aircraft or in the microSD card mounted on the aircraft. The aircraft does not need to be powered on during the exporting process.
- Remove the microSD card from the aircraft and insert it into a card reader, and export the footage in the microSD card through the card reader.



- DO NOT remove the microSD card from the aircraft when taking photos or videos. Otherwise, the microSD card may be damaged.
 - Check camera settings before use to ensure they are configured correctly.
 - Before shooting important photos or videos, shoot a few images to test whether the camera is operating correctly.
 - Make sure to power off the aircraft correctly. Otherwise, the camera parameters will not be saved, and any recorded videos may be affected. DJI is not responsible for any loss caused by an image or video recorded in a way that is not machine-readable.
-

QuickTransfer

The aircraft can connect directly to mobile devices via Wi-Fi, enabling users to download photos and videos from the aircraft to the mobile device through DJI Fly without using the remote controller. Users can enjoy faster and more convenient downloads with a transmission rate of up to 30 MB/s.

Usage

Method 1: mobile device is not connected to the remote controller

1. Power on the aircraft and wait until the self-diagnostic tests of the aircraft are complete.
2. Make sure Bluetooth and Wi-Fi are enabled on the mobile device. Launch DJI Fly and a prompt will appear to connect to the aircraft.
3. Tap Connect. Once successfully connected, the files on the aircraft can be accessed and

downloaded at high speed. When connecting the mobile device to the aircraft for the first time, press and hold the power button of the aircraft for two seconds to confirm.

Method 2: mobile device is connected to the remote controller

1. Make sure that the aircraft is connected to the mobile device via the remote controller and the motors are off.
2. Enable Bluetooth and Wi-Fi on the mobile device.
3. Launch DJI Fly, enter playback, and tap  in the upper right corner to access the files on the aircraft to download at high speed.



- DJI RC 2 does not support QuickTransfer.

- The maximum download rate can only be achieved in countries and regions where the 5.8 GHz frequency is permitted by laws and regulations, when using devices that support 5.8 GHz frequency band and Wi-Fi connection, and in an environment without interference or obstruction. If 5.8 GHz is not allowed by local regulations (such as in Japan), or the mobile device of the user does not support the 5.8 GHz frequency band, or the environment has severe interference, then QuickTransfer will use the 2.4 GHz frequency band and its maximum download rate will reduce to 6 MB/s.
 - Make sure that Bluetooth, Wi-Fi, and location services are enabled on the mobile device before using QuickTransfer.
 - When using QuickTransfer, it is not necessary to enter the Wi-Fi password on the settings page of the mobile device in order to connect. Launch DJI Fly and a prompt will appear to connect the aircraft.
 - Use QuickTransfer in an unobstructed environment with no interference and stay away from sources of interference such as wireless routers, Bluetooth speakers, or headphones.
-

Remote Controller

This chapter describes the features of the remote controller and includes instructions for controlling the aircraft and the camera.

Remote Controller

DJI RC 2

The DJI RC 2 remote controller features O4 video transmission when used with DJI Mini 4 Pro, and works at 2.4 GHz, 5.8 GHz and 5.1 GHz frequency bands. It is capable of selecting the best transmission channel automatically and can transmit 1080p 60fps HD live view from the aircraft to the remote controller at a distance of up to 20 km (12.4 mi) (compliant with FCC standards, and measured in a wide open area without interference). Equipped with a 5.5-in touchscreen (1920×1080 pixel resolution) and a wide range of controls and customizable buttons, DJI RC 2 enables users to easily control the aircraft and remotely change the aircraft settings. DJI RC 2 comes with many other functions such as built-in GNSS (GPS+Galileo+BeiDou), Bluetooth, and Wi-Fi connection.

The remote controller has detachable control sticks, built-in speakers, a 32GB internal storage, and supports the use of a microSD card for additional storage needs.

The 6200mAh 22.32Wh battery provides the remote controller with a maximum operating time of three hours.



- The 5.1 GHz band can be used only in countries and regions where it is permitted by local laws and regulations.

Operation

Powering On/Off

Press the power button once to check the current battery level.

Press once, then press and hold for two seconds to power the remote controller on or off.

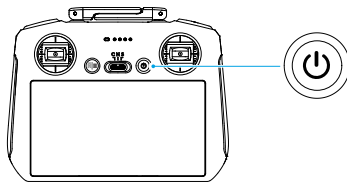

Charging the Battery

Connect the charger to the USB-C port on the remote controller. It takes approximately 1 hour and 30 minutes to fully charge the remote controller (with a 9V/3A USB charger).

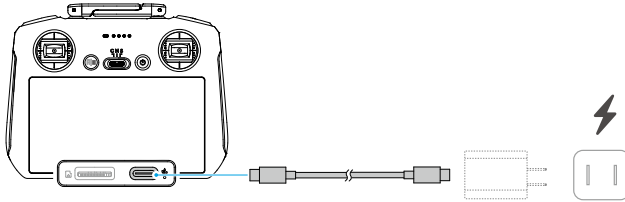

Controlling the Gimbal and Camera

1. Focus/Shutter Button: press halfway down to auto-focus and press all the way down to take a photo.
2. Record Button: press once to start or stop recording.
3. Camera Control Dial: use to adjust the zoom by default. The dial function can be set to adjust the focal length, EV, shutter speed, and ISO.
4. Gimbal Dial: control the tilt of the gimbal.

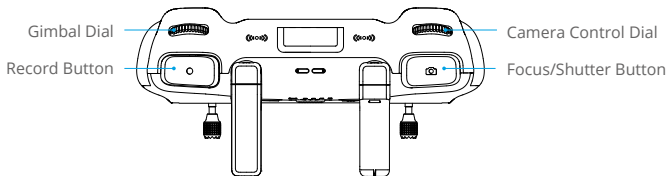

Controlling the Aircraft

Three preprogrammed modes (Mode 1, Mode 2, and Mode 3) are available and custom modes can be configured in DJI Fly.

Mode 1

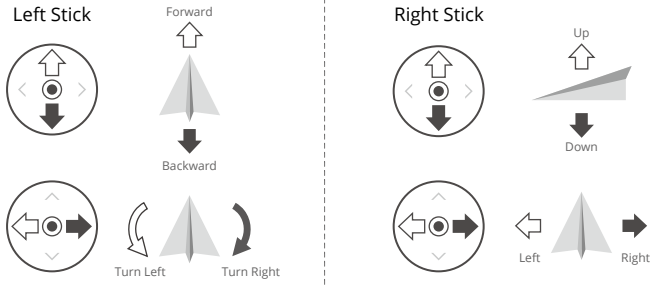

Mode 2

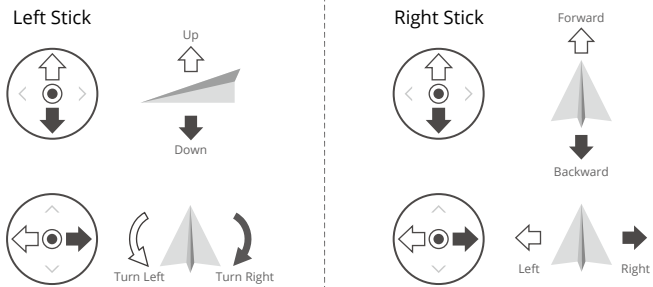



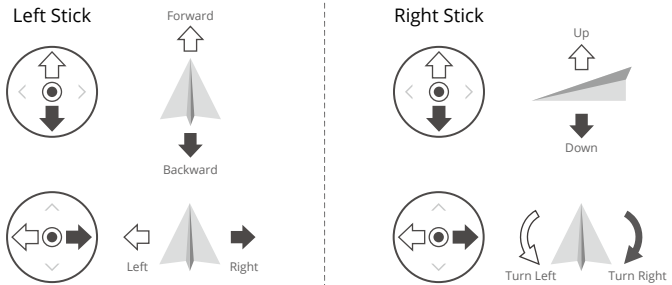



Mode 3

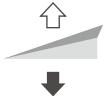

The default control mode of the remote controller is Mode 2. In this manual, Mode 2 is used as an example to illustrate how to use the control sticks.



- Stick Neutral/Center Point: control sticks are in the center.
- Moving the control stick: the control stick is pushed away from the center position.

Remote Controller (Mode 2)	Aircraft	Remarks
		<p>Throttle Stick: moving the left stick up or down changes the altitude of the aircraft.</p> <ul style="list-style-type: none"> • Push the stick up to ascend and push down to descend. • The aircraft hovers in place if the stick is in the center. • The more the stick is pushed away from the center, the faster the aircraft changes elevation. <p>Use the left stick to take off when the motors are spinning at an idle speed. Push the stick gently to prevent sudden and unexpected changes in altitude.</p>
		<p>Yaw Stick: moving the left stick to the left or right controls the orientation of the aircraft.</p> <ul style="list-style-type: none"> • Push the stick left to rotate the aircraft counterclockwise and right to rotate the aircraft clockwise. • The aircraft hovers in place if the stick is in the center. • The more the stick is pushed away from the center, the faster the aircraft rotates.
		<p>Pitch Stick: moving the right stick up and down to change the pitch of the aircraft.</p> <ul style="list-style-type: none"> • Push the stick up to fly forward and down to fly backward. • The aircraft hovers in place if the stick is in the center. • The more the stick is pushed away from the center, the faster the aircraft moves.
		<p>Roll Stick: moving the right stick to the left or right changes the roll of the aircraft.</p> <ul style="list-style-type: none"> • Push the stick left to fly left and right to fly right. • The aircraft hovers in place if the stick is in the center. • The more the stick is pushed away from the center, the faster the aircraft moves.

Flight Mode Switch

Toggle the switch to select the desired flight mode.

Position	Flight Mode
S	Sport Mode
N	Normal Mode
C	Cine Mode

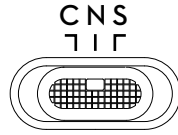

Flight Pause/RTH Button

Press once to make the aircraft brake and hover in place.

Press and hold the button until the remote controller beeps and starts RTH. The aircraft will return to the last recorded Home Point. Press the button again to cancel RTH and regain control of the aircraft.

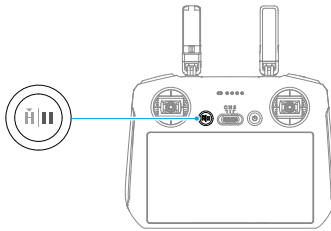

Customizable Button

Go to Settings > Control in DJI Fly to set the functions of the customizable C1 and C2 buttons.

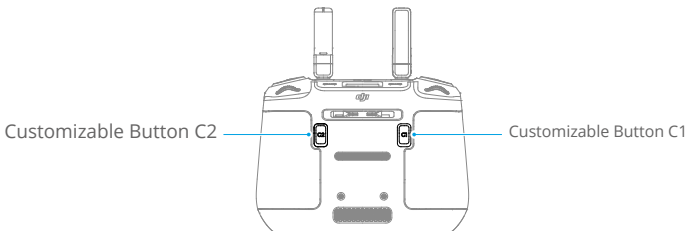

Remote Controller LEDs

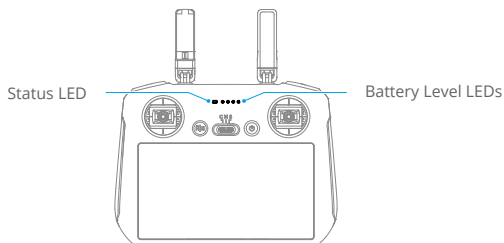

Status LED

Blinking Pattern	Descriptions
— Solid red	Disconnected from the aircraft.
..... Blinking red	The battery level of the aircraft is low.
— Solid green	Connected with the aircraft.
..... Blinking blue	The remote controller is linking to an aircraft.
— Solid yellow	Firmware update failed.
— Solid blue	Firmware update successful.
..... Blinking yellow	The battery level of the remote controller is low.
..... Blinking cyan	Control sticks not centered.

Battery Level LEDs

Blinking Pattern				Battery Level
				76%-100%
				51%-75%
				26%-50%
				0%-25%

Remote Controller Alert

The remote controller beeps to indicate an error or warning. Pay attention when prompts appear on the touchscreen or in DJI Fly. Slide down from the top of the screen and select Mute to disable all alerts, or slide the volume bar to 0 to disable some alerts.

The remote controller sounds an alert during RTH. The alert cannot be canceled. The remote controller sounds an alert when the battery level of the remote controller is low (6% to 10% battery level). A low battery level alert can be canceled by pressing the power button. The critical low battery level alert, which is triggered when the battery level is less than 5% and cannot be canceled.

Optimal Transmission Zone

The signal between the aircraft and the remote controller is most reliable when the antennas are positioned in relation to the aircraft as illustrated below.

The optimal transmission range is where the antennas face toward the aircraft and the angle between the antennas and the back of the remote controller is 180° or 270° .

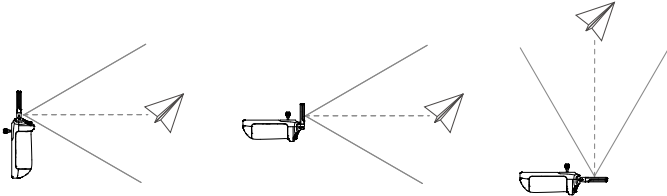

-
- ⚠ • DO NOT use other wireless devices operating at the same frequency as the remote controller. Otherwise, the remote controller will experience interference.
 - A prompt will be displayed in DJI Fly if the transmission signal is weak during flight. Adjust the antennas to make sure that the aircraft is in the optimal transmission range.
-

Linking the Remote Controller

The remote controller is already linked to the aircraft when purchased together as a combo. Otherwise, follow the steps below to link the remote controller and the aircraft after activation.

1. Power on the aircraft and the remote controller.
2. Launch DJI Fly.
3. In camera view, tap ●●● and select Control and then Re-pair to Aircraft. During linking, the status LED of the remote controller blinks blue and the remote controller beeps.
4. Press and hold the power button of the aircraft for more than four seconds. The aircraft beeps once, and its battery level LEDs blink in sequence to indicate it is ready to link. The remote controller will beep twice, and its status LED will turn solid green to indicate linking is successful.

-
- 💡 • Make sure the remote controller is within 0.5 m of the aircraft during linking.
 - The remote controller will automatically unlink from an aircraft if a new remote controller is linked to the same aircraft.
 - Turn off Bluetooth and Wi-Fi for optimal video transmission.
-

- ⚠ • Fully charge the remote controller before each flight. The remote controller sounds an alert when the battery level is low.

- ⚠ • If the remote controller is powered on and not in use for five minutes, an alert will sound. After six minutes, the remote controller automatically powers off. Move the control sticks or press any button to cancel the alert.
 - Fully charge the battery at least once every three months to maintain the battery's health.
 - DO NOT operate the aircraft when the light condition is too bright or too dark using the remote controller to monitor flight. User is responsible for the correct adjustment of display brightness and shall take care of direct sunshine onto the screen during flight operation.
-

Operating the Touchscreen

Home

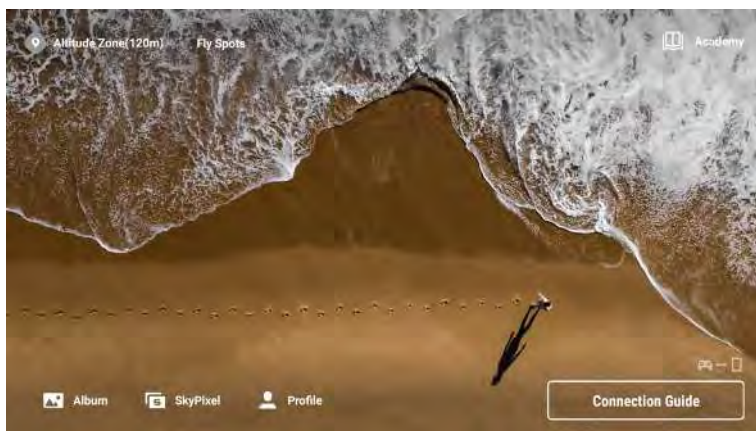

Screen Gestures

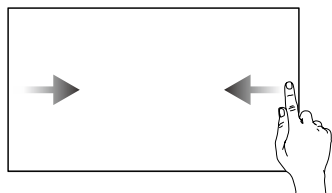

Slide from the left or right to the center of the screen to return to the previous screen.

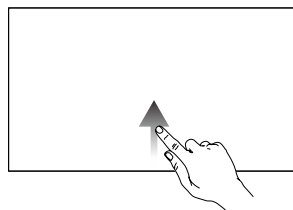

Slide up from the bottom of the screen to return to DJI Fly.

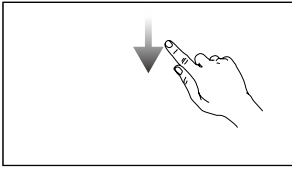

Slide down from the top of the screen to open the status bar when in DJI Fly.

The status bar displays the time, Wi-Fi signal, battery level of the remote controller, etc.

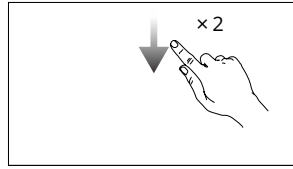

Slide down twice from the top of the screen to open Quick Settings when in DJI Fly.

Quick Settings

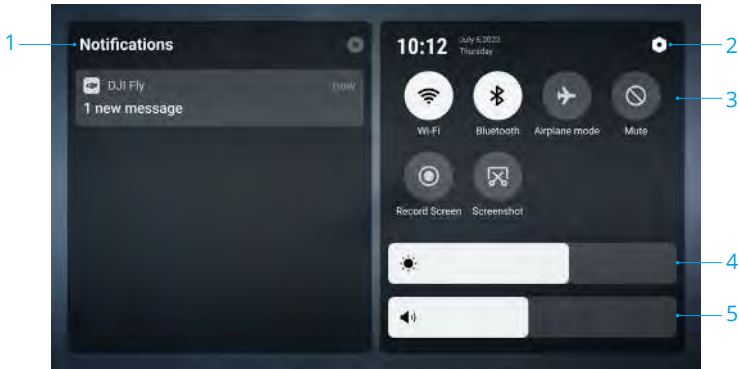

1. Notifications

Tap to check system notifications.

2. System Settings

Tap to access system settings and configure settings such as Bluetooth, volume, and network. Users can also view the Guide to learn more about the controls and status LEDs.

3. Shortcuts

 : tap to enable or disable Wi-Fi. Hold to enter settings and then connect to or add a Wi-Fi network.

 : tap to enable or disable Bluetooth. Hold to enter settings and connect with nearby Bluetooth devices.

 : tap to enable Airplane mode. Wi-Fi and Bluetooth will be disabled.

 : tap to turn off system notifications and disable all alerts.

 : tap to start recording the screen.

 : tap to take a screenshot.

4. Adjusting Brightness

Slide the bar to adjust the screen brightness.

5. Adjusting Volume

Slide the bar to adjust the volume.

Advanced Features

The compass may need to be calibrated after the remote controller is used in areas with electromagnetic interference. A warning prompt will appear if the compass of the remote controller requires calibration. Tap the warning prompt to start calibrating. In other cases, follow the steps below to calibrate the remote controller.

1. Power on the remote controller, and enter Quick Settings.
2. Select System Settings , scroll down, and tap Compass.
3. Follow the on-screen instructions to calibrate the compass.
4. A prompt will be displayed when the calibration is successful.

DJI RC-N2

The DJI RC-N2 remote controller features O4 video transmission when used with DJI Mini 4 Pro, the remote controller works at 2.4 GHz, 5.8 GHz and 5.1 GHz frequency bands. The remote controller is also capable of selecting the best transmission channel automatically and can transmit 1080p 60fps HD live view from the aircraft to DJI Fly on a mobile device (depending on mobile device performance) at a maximum transmission range of 20 km (12.4 mi) (compliant with FCC standards, and measured in a wide open area without interference). Users can control the aircraft and change the settings easily within this range. The retractable mobile device holder can be used to place mobile devices stably, and the control sticks are removable and easy to store.

The built-in battery has a capacity of 5200 mAh and power of 18.72 Wh that supports a maximum run time of six hours (when not charging the mobile device).

- ⚠ • The 5.1 GHz band can be used only in countries and regions where it is permitted by local laws and regulations.

Operation

Powering On/Off

Press the power button once to check the current battery level.

Press once, then press and hold for two seconds to power the remote controller on or off.

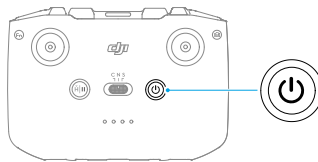

Charging the Battery

Connect the charger to the USB-C port on the remote controller.

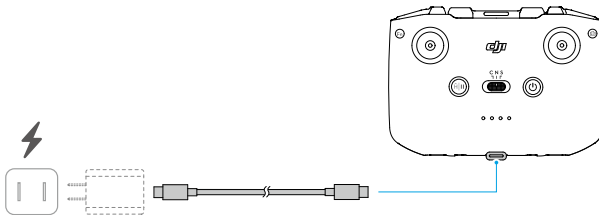

Controlling the Gimbal and Camera

1. Shutter/Record Button: Press once to take a photo or to start or stop recording.
2. Photo/Video Toggle: Press once to switch between photo and video mode.

3. Gimbal Dial: control the tilt of the gimbal.
4. Customizable Button: Press and hold the customizable button and then use the gimbal dial to zoom in or out.

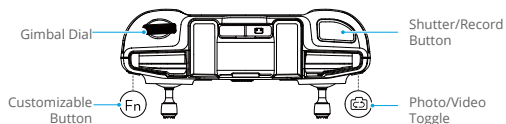

Controlling the Aircraft

Three preprogrammed modes (Mode 1, Mode 2, and Mode 3) are available and custom modes can be configured in DJI Fly.

Mode 1

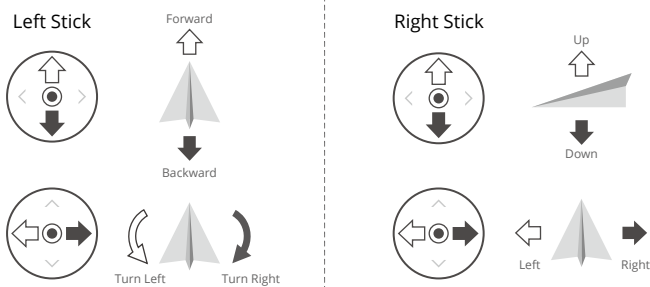

Mode 2

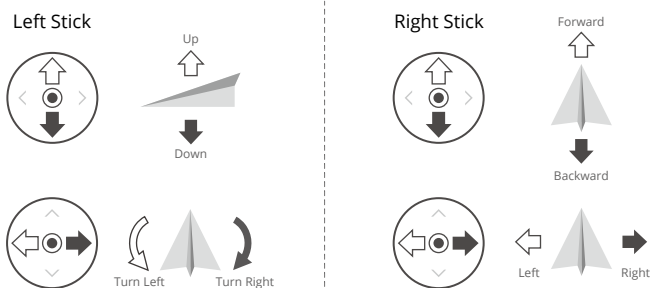



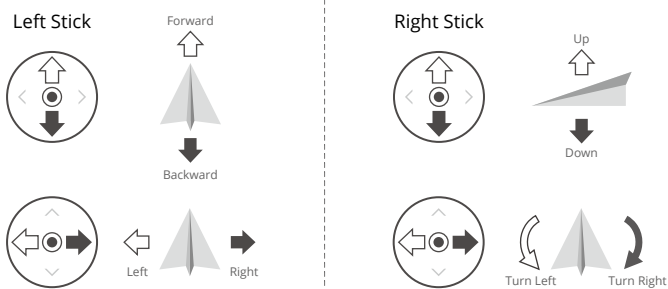



Mode 3

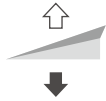
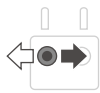

The default control mode of the remote controller is Mode 2. In this manual, Mode 2 is used as an example to illustrate how to use the control sticks.

-  • Stick Neutral/Center Point: control sticks are in the center.
- Moving the control stick: the control stick is pushed away from the center position.

Remote Controller (Mode 2)	Aircraft	Remarks
		<p>Throttle Stick: moving the left stick up or down changes the altitude of the aircraft.</p> <ul style="list-style-type: none"> • Push the stick up to ascend and push down to descend. • The aircraft hovers in place if the stick is in the center. • The more the stick is pushed away from the center, the faster the aircraft changes elevation. <p>Use the left stick to take off when the motors are spinning at an idle speed. Push the stick gently to prevent sudden and unexpected changes in altitude.</p>
		<p>Yaw Stick: moving the left stick to the left or right controls the orientation of the aircraft.</p> <ul style="list-style-type: none"> • Push the stick left to rotate the aircraft counterclockwise and right to rotate the aircraft clockwise. • The aircraft hovers in place if the stick is in the center. • The more the stick is pushed away from the center, the faster the aircraft rotates.
		<p>Pitch Stick: moving the right stick up and down to change the pitch of the aircraft.</p> <ul style="list-style-type: none"> • Push the stick up to fly forward and down to fly backward. • The aircraft hovers in place if the stick is in the center. • The more the stick is pushed away from the center, the faster the aircraft moves.
		<p>Roll Stick: moving the right stick to the left or right changes the roll of the aircraft.</p> <ul style="list-style-type: none"> • Push the stick left to fly left and right to fly right. • The aircraft hovers in place if the stick is in the center. • The more the stick is pushed away from the center, the faster the aircraft moves.

Flight Mode Switch

Toggle the switch to select the desired flight mode.

Position	Flight Mode
S	Sport Mode
N	Normal Mode
C	Cine Mode

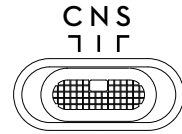

Flight Pause/RTH Button

Press once to make the aircraft brake and hover in place.

Press and hold the button until the remote controller beeps and starts RTH. The aircraft will return to the last recorded Home Point. Press this button again to cancel RTH and regain control of the aircraft.

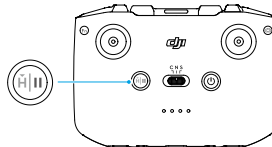

Customizable Button

Go to Settings in DJI Fly and select Control to set the functions of the customizable button.

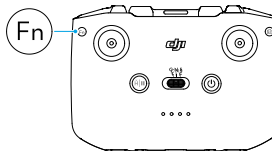

Battery Level LEDs

Battery Level LEDs

Blinking Pattern				Battery Level
●	●	●	●	76%-100%
●	●	●	○	51%-75%
●	●	○	○	26%-50%
●	○	○	○	0%-25%

Remote Controller Alert

The remote controller sounds an alert during RTH. The alert cannot be canceled. The remote controller sounds an alert when the battery level of the remote controller is low (6% to 10%). A low battery level alert can be cancelled by pressing the power button. The critical low battery level alert, which is triggered when the battery level is less than 5%, cannot be canceled.

Optimal Transmission Zone

The signal between the aircraft and the remote controller is most reliable when the antennas are positioned in relation to the aircraft as illustrated below.

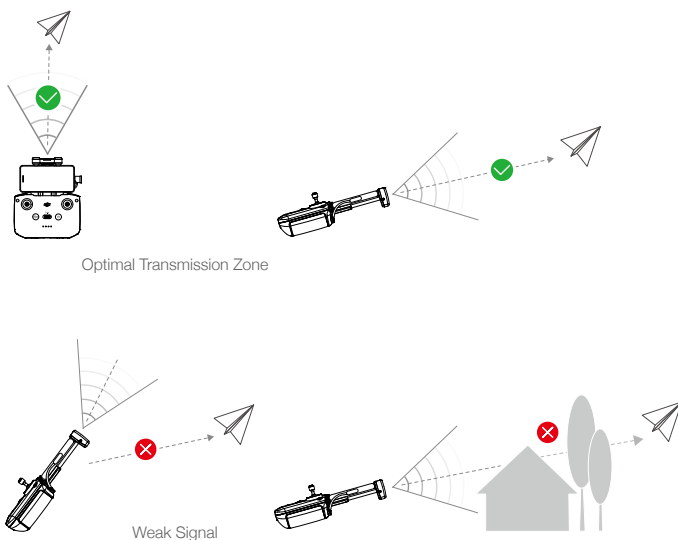

- DO NOT use other wireless devices operating at the same frequency as the remote controller. Otherwise, the remote controller will experience interference.
- A prompt will be displayed in DJI Fly if the transmission signal is weak during flight. Adjust the remote controller orientation to make sure that the aircraft is in the optimal transmission range.

Linking the Remote Controller

The remote controller is already linked to the aircraft when purchased together as a combo. Otherwise, follow the steps below to link the remote controller and the aircraft after activation.

1. Power on the aircraft and the remote controller.
2. Connect a mobile device to the remote controller, and Launch DJI Fly.
3. In camera view, tap ●●● and select Control and then Re-pair to Aircraft. The remote controller beeps during linking.
4. Press and hold the power button of the aircraft for more than four seconds. The aircraft beeps once, and its battery level LEDs blink in sequence to indicate it is ready to link. After the linking is successful, the battery level LEDs of the remote controller will appear on and solid.



- Make sure the remote controller is within 0.5 m of the aircraft during linking.
- The remote controller will automatically unlink from an aircraft if a new remote controller is linked to the same aircraft.
- Turn off Bluetooth and Wi-Fi of the remote controller for optimal video transmission.



- Fully charge the remote controller before each flight. The remote controller sounds an alert when the battery level is low.
 - If the remote controller is powered on and not in use for five minutes, an alert will sound. After six minutes, the remote controller automatically powers off. Move the control sticks or press any button to cancel the alert.
 - Adjust the mobile device holder to make sure your mobile device is secure.
 - Fully charge the battery at least once every three months to maintain the battery's health.
 - DO NOT operate the aircraft when the light condition is too bright or too dark using mobile phone to monitor flight. User is responsible for the correct adjustment of display brightness and shall take care of direct sunshine onto the screen during flight operation.
 - Make sure to use a mobile device together with the DJI RC-N2 remote controller to control the aircraft. If the mobile device turns off for any reason, land the aircraft as soon as possible for safety.
-

DJI Fly App

This section introduces the main functions of the DJI Fly app.

DJI Fly App

Home

Launch DJI Fly and enter the home screen.

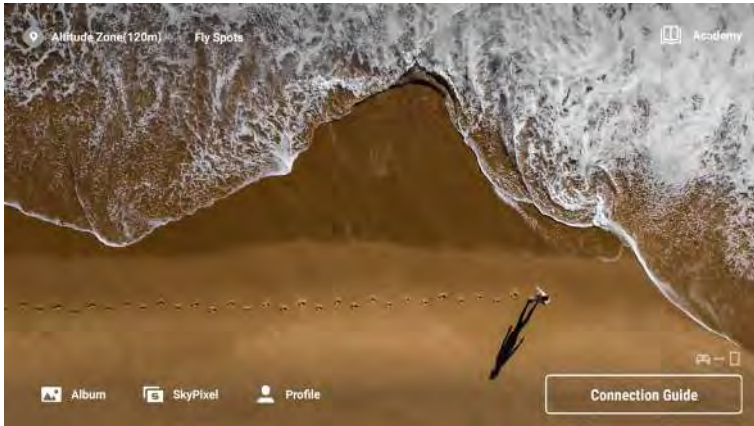

Fly Spots

View or share flight and shooting locations nearby, learn more about GEO Zones, and preview aerial photos of different locations taken by other users.

Academy

Tap the icon in the top right corner to enter Academy and view product tutorials, flight tips, flight safety notices, and manual documents.

Album

Allows you to view photos and videos from the aircraft album or saved on the local device. Tap Create and select Templates or Pro. Templates provide an auto-edit feature for imported footage. Pro allows users to edit footage manually.

SkyPixel

Enter SkyPixel to view videos and photos shared by other users.

Profile

View account information and flight records; visit the DJI forum and online store, access the Find My Drone feature, offline maps, and other settings such as firmware updates, camera view, cached data, account privacy, and language.

Camera View

Button Descriptions

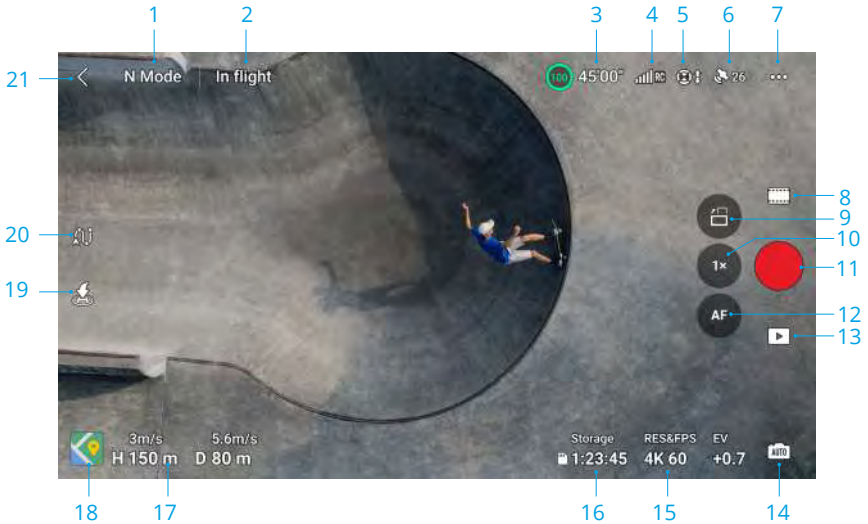

1. Flight Mode

N Mode: displays the current flight mode.

2. System Status Bar

In Flight: displays aircraft flight status and various warning messages. Tap to view more information when a warning prompt appears.

3. Battery Information

(80) 24'17" : displays the current battery level and remaining flight time. Tap to view more information about the battery.

4. Video Downlink Signal Strength

📶 : displays the video downlink signal strength between the aircraft and the remote controller.

5. Vision System Status

👁️ : the left side of the icon indicates the status of the horizontal vision system and the right side of the icon indicates the status of the upward and downward vision systems. The icon is white when the vision system is working normally and turns red when the vision system is unavailable.

6. GNSS Status

📶 26 : displays the current GNSS signal strength. Tap to check the GNSS signal status. The Home Point can be updated when the icon is white, which indicates the GNSS signal is strong.

7. Settings

••• : tap to view or set parameters for safety, control, camera, and transmission. Refer to the Settings section for more information.

8. Shooting Modes



Photo: Single, AEB, Burst Shooting, and Timed Shot.



Video: Normal, Night, and Slow Motion.



MasterShots: drag-select a subject. The aircraft will record while executing different maneuvers in sequence and keep the subject in the center of the frame. A short cinematic video will be generated afterward.



QuickShots: Dronie, Rocket, Circle, Helix, Boomerang, and Asteroid.



Hyperlapse: Free, Circle, Course Lock, and Waypoints.



Pano: Sphere, 180°, Wide Angle, and Vertical. The aircraft will automatically take several photos and synthesize a panoramic photo based on the selected panoramic photo type.



• The Night video mode provides better noise reduction and cleaner footage, supports up to 12800 ISO.



• The Night video mode currently supports 4K 24/25/30fps and 1080p 24/25/30fps.
• FocusTrack is not supported in Night video mode.

9. Landscape/Portrait Mode Switch



: tap to switch between Landscape and Portrait modes. The camera will rotate 90 degrees when switching to Portrait mode, for shooting portrait videos and photos. Portrait mode is not supported when using Pano or the Asteroid shooting mode in QuickShots.

10. Zoom



: displays the zoom ratio. Tap to adjust the zoom ratio. Tap and hold the icon to expand the zoom bar and slide on the bar to adjust the zoom ratio. Use two fingers on the screen to zoom in or out.



• Digital zoom is only supported when taking 12MP photo, or recording in Normal or Night video mode.
• When zooming in or out, the larger the zoom ratio, the slower the aircraft will rotate to achieve a smooth view.

11. Shutter/Record Button



: tap to take a photo or to start or stop recording a video.

12. Focus Button



: tap to switch between AF and MF. Press and hold the icon to bring up the focus bar to adjust the focus.

13. Playback



: tap to enter playback and preview photos and videos as soon as they are captured.

14. Camera Mode Switch

Auto : tap to switch between Auto and Pro mode. Different parameters can be set in different modes.

15. Shooting Parameters

RES/FFPS 4K 60 : displays the current shooting parameters. Tap to access parameter settings.

16. Storage Information

Storage 1:23:45 : displays the remaining number of photos or video recording time of the current storage. Tap to view the available capacity of the aircraft internal storage or the microSD card. Tap to view more information about the storage.

17. Flight Telemetry

Displays the horizontal distance (D) between the aircraft and the Home Point, height (H) from the Home Point, aircraft horizontal speed, and aircraft vertical speed.

18. Map

Map Icon : tap to expand to the mini map, and tap the center of the mini map to switch from the camera view to the map view. The mini map can be switched to the attitude indicator.

- **Mini Map**: displays the map in the bottom left corner of the screen so that the user can simultaneously check the camera view, the real-time position and orientation of the aircraft and the remote controller, the Home Point location, and flight paths, etc.

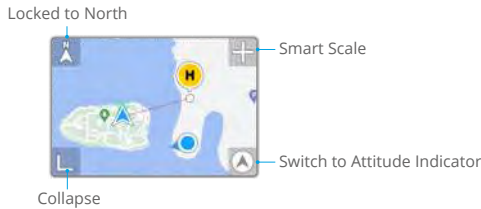

Locked to North	North is locked on the map with North pointing upward in the map view. Tap to switch from Lock to North to the remote controller orientation where the map rotates when the remote controller changes the orientation.
Smart Scale	tap the +/- icon to slightly zoom in or out.
Switch to Attitude Indicator	tap to switch from the mini map to the attitude indicator.
Collapse	tap to minimize the map.

- **Attitude Indicator**: displays the attitude indicator in the bottom left corner of the screen so that the user can simultaneously check the camera view, the relative location and orientation of the aircraft and the remote controller, the Home Point location, and the aircraft horizontal attitude information, etc. The attitude indicator supports displaying the aircraft or the remote controller as the center.

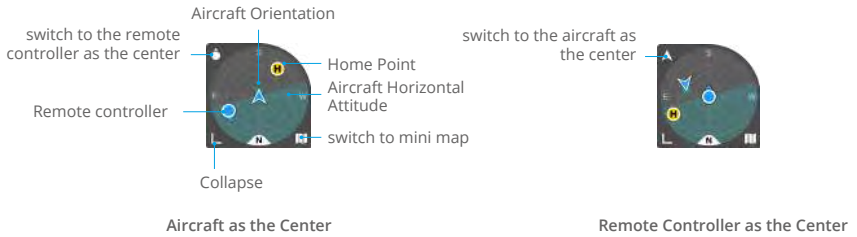

Switch to the aircraft/remote controller as the center	Tap to switch to aircraft/remote controller as the center of the attitude indicator.
Aircraft Orientation	Indicates the aircraft orientation. When the aircraft is displayed as the center of the attitude indicator and the user is changing the aircraft orientation, all the other elements on the attitude indicator will rotate around the aircraft icon. The arrow direction of the aircraft icon stays unchanged.
Aircraft Horizontal Attitude	Indicates the aircraft horizontal attitude information (including pitch and roll). The deep cyan area is horizontal and in the center of the attitude indicator when the aircraft hovers in place. If not, it indicates that the wind is changing the aircraft attitude. Fly with caution. The deep cyan area changes in real time based on the aircraft horizontal attitude.
Switch to the Mini Map	Tap to switch from the attitude indicator to the mini map.
Collapse	Tap to minimize the attitude indicator.
Home Point	The location of the Home Point. To manually control the aircraft to return home, adjust the aircraft orientation to point towards the Home Point first.
Remote Controller	The dot indicates the remote controller location, while the arrow on the dot indicates the remote controller orientation. Adjust the remote controller orientation during the flight to make sure the arrow points towards the aircraft icon for optimal signal transmission.

19. Auto Takeoff/Landing/RTH

: tap the icon. When the prompt appears, press and hold the button to initiate auto takeoff or landing.

: tap to initiate RTH and have the aircraft return to the last recorded Home Point.

20. Waypoint Flight

: tap to enable/disable Waypoint Flight.

21. Back

⏪: tap to return to the home screen.

Screen Shortcuts

Gimbal Angle Adjustment

Press and hold on the screen to bring up the gimbal adjustment bar and adjust the gimbal angle.

Focus/Spot Metering

Tap on the screen to enable focus or spot metering. Focus or spot metering will display differently depending on the shooting mode, focus mode, exposure mode, and spot metering mode.

After using spot metering:

- Drag  next to the box up and down to adjust the EV (exposure value).
- Press and hold the box on the screen to lock the exposure. To unlock the exposure, tap and hold on the screen again or tap on another area of the screen.

Settings

Safety

- Flight Assistance

Obstacle Avoidance Action	Omnidirectional vision system is enabled after setting Obstacle Avoidance Action to Bypass or Brake. The aircraft cannot sense obstacles if Obstacle Avoidance is disabled.
---------------------------	---

Bypassing Options	Select Normal or Nifty mode when using Bypass.
-------------------	--

Display Radar Map	When enabled, the real-time obstacle detection radar map will be displayed.
-------------------	---

- Return to Home (RTH): set Advanced RTH, Auto RTH Altitude, and to update the Home Point.
- AR Settings: enable display of AR Home Point, AR RTH Route, and AR Aircraft Shadow.
- Flight Protection: set the max altitude and the max distance for flights.
- Sensors: tap to view the IMU and compass statuses and start calibration if necessary.
- Battery: tap to view battery information such as battery cell status, serial number, and number of times charged.
- Auxiliary LED: tap to set the auxiliary LED to auto, on, or off. DO NOT turn on the Auxiliary LED before takeoff.
- Unlock GEO Zone: tap to view information about unlocking GEO Zones.
- Find My Drone: this feature helps to find the location of the aircraft, either by enabling the

aircraft to flash or beep or by using the map.

- Advanced Safety Settings

Signal Lost	The behavior of the aircraft when the remote controller signal is lost can be set to RTH, Descend, or Hover.
Emergency Propeller Stop	Emergency Only indicates that the motors can only be stopped by performing a combination stick command (CSC) for at least 2 seconds mid-flight in an emergency situation, such as if there is a collision, a motor has stalled, the aircraft is rolling in the air, or the aircraft is out of control and is ascending or descending very quickly. Anytime indicates that the motors can be stopped mid-flight anytime once user performs a CSC. Stopping the motors mid-flight will cause the aircraft to crash.

Control

- Aircraft Settings

Units	Can be set to metric or imperial.
Subject Scanning	When enabled, the aircraft automatically scans and displays subjects in the camera view (only available for single-shot and normal video modes).
FocusTrack Settings	set tracking distance and height of the Inner/Outer circle for different kinds of tracking subject, select Camera Motion when the aircraft is bypassing obstacles, enable or disable Near-Ground Flight, and reset FocusTrack Settings.
Gain and Expo Tuning	Supports the gain and expo settings to be fine-tuned for the aircraft and the gimbal in different flight modes, including the max horizontal speed, max ascent speed, max descent speed, max angular velocity, yaw smoothness, brake sensitivity, expo, and the gimbal max tilt control speed and tilt smoothness.

 • When releasing the joystick, an increased brake sensitivity reduces the braking distance of the aircraft, while a decreased brake sensitivity increases the braking distance. Fly with caution.

- Gimbal Settings: tap to set the gimbal mode, perform gimbal calibration, and recentre the gimbal or move it downward.
- Remote Controller Settings: tap to set the function of the customizable button, calibrate the remote controller, switch control stick modes. Make sure to understand the operations of a stick mode before changing the control stick mode.
- Flight Tutorial: view the flight tutorial.
- Re-pair to Aircraft (Link): tap to start linking when the aircraft is not linked to the remote controller.

Camera

- Camera Parameter Settings: displays different settings according to the shooting mode.

Shooting Modes	Settings
Photo Mode	Format, Aspect Ratio, Resolution
Record Mode	Color, Coding Format, Video Subtitles
MasterShots	Color, Coding Format, Video Subtitles
QuickShots	Color, Coding Format, Video Subtitles ^[1]
Hyperlapse	Photo Type, Shot Frame
Pano	Photo Type

[1] Video subtitles are not supported in Asteroid.

- General Settings

Anti-Flicker	When enabled, the footage flicker caused by the light source will be reduced when shooting in environments with lights.  In Pro mode, anti-flicker will only take effect when shutter speed and ISO are set to auto.
Histogram	When enabled, users can check the screen to view whether the exposure is appropriate.
Peaking Level	When enabled in MF mode, the objects in focus will be outlined in red. The higher the peaking level, the thicker the outline.
Overexposure Warning	When enabled, the overexposure area will be identified with diagonal lines.
Gridlines	Enable gridlines such as diagonal lines, nine-square grids, and center point.
White Balance	Set to auto, or manually adjust the color temperature.
Style	Adjust sharpness and noise reduction of the video. Only supported in video recording, MasterShots, and QuickShots.

- Storage Settings

Storage Location	Store the recorded files to the microSD card on the aircraft or the internal storage of the aircraft. DJI Mini 4 Pro has an internal storage of 2 GB.
Custom Folder Naming	When changed, a new folder will be automatically created on the aircraft storage to store future files.
Custom File Naming	When changed, new naming will be applied to future files on the aircraft storage.
Cache When Recording	When enabled, the liveview on the remote controller will be stored in the remote controller storage when recording video.

Max Video Cache Capacity	When the cache limit is reached, the earliest caches will be automatically deleted.
--------------------------	---

- Reset Camera Settings: tap to restore camera parameters to the default settings.

Transmission

A livestreaming platform can be selected to broadcast the camera view in real time. The frequency band and channel mode can also be set in the transmission settings.

About

Displays information such as the Device Name, Wi-Fi Name, Model, App Version, Aircraft Firmware, RC Firmware, FlySafe Data, SN, etc.

Tap Reset All Settings to reset settings including camera, gimbal and safety settings to default.

- ⚠ • Fully charge the device before launching DJI Fly.
 - Mobile cellular data is required when using DJI Fly. Contact your wireless carrier for data charges.
 - DO NOT accept phone calls or use texting features during flight if you are using a mobile phone as your display device.
 - Read all safety prompts, warning messages, and disclaimers carefully. Familiarize yourself with relevant regulations in your area. You are solely responsible for being aware of all relevant regulations and flying in a way that is compliant.
 - a. Read and understand the warning messages before using the auto-takeoff and auto-landing features.
 - b. Read and understand the warning messages and disclaimers before setting the altitude beyond the default limit.
 - c. Read and understand the warning messages and disclaimers before switching flight modes.
 - d. Read and understand the warning messages and disclaimer prompts near or in GEO zones.
 - e. Read and understand the warning messages before using the Intelligent Flight modes.
 - Land the aircraft immediately at a safe location if a prompt appears in the app instructing you to do so.
 - Review all warning messages on the checklist displayed in the app before each flight.
 - Use the in-app tutorial to practice your flight skills if you have never operated the aircraft or if you do not have sufficient experience to operate the aircraft with confidence.
 - The app is designed to assist your operation. Use sound discretion and DO NOT rely on the app to control the aircraft. The use of the app is subject to DJI Fly Terms of Use and DJI Privacy Policy. Read them carefully in the app.
-

Appendix

Appendix

Specifications

Aircraft

Takeoff Weight ^[1]	< 249 g
Dimensions	Folded (without propellers): 148×94×64 mm Unfolded (without propellers): 298×373×101 mm
Max Ascent Speed	5 m/s (S Mode) 5 m/s (N Mode) 3 m/s (C Mode)
Max Descent Speed	5 m/s (S Mode) 5 m/s (N Mode) 3 m/s (C Mode)
Max Horizontal Speed (at sea level, no wind) ^[2]	16 m/s (S Mode) 12 m/s (N Mode) 12 m/s (C Mode)
Max Takeoff Altitude ^[3]	With DJI Mini 4 Pro Intelligent Flight Battery: 4000 m With DJI Mini 3 Series Intelligent Flight Battery Plus: 3000 m
Max Flight Time ^[4]	34 minutes (with Intelligent Flight Battery) 45 minutes (with Intelligent Flight Battery Plus)
Max Hovering Time ^[5]	30 minutes (with Intelligent Flight Battery) 39 minutes (with Intelligent Flight Battery Plus)
Max Flight Distance	18 km (with Intelligent Flight Battery and measured while flying at 40.7 kph in a windless environment at 20 meters above sea level) 25 km (with Intelligent Flight Battery Plus and measured while flying at 44.3 kph in a windless environment at 20 meters above sea level)
Max Wind Speed Resistance	10.7 m/s
Max Pitch Angle	35°
Operating Temperature	-10° to 40° C (14° to 104° F)
GNSS	GPS + Galileo + BeiDou
Hovering Accuracy Range (windless or breezy)	Vertical: ±0.1 m (with vision positioning) ±0.5 m (with GNSS positioning) Horizontal: ±0.1 m (with vision positioning) ±0.5 m (with GNSS positioning)
Internal Storage	2 GB

Camera

Image Sensor	1/1.3-inch CMOS, Effective Pixels: 48 MP
--------------	--

Lens	FOV: 82.1° Format Equivalent: 24 mm Aperture: f/1.7 Focus: 1 m to ∞
ISO Range	Video Normal and Slow Motion: 100-6400 (Normal) 100-1600 (D-Log M) 100-1600 (HLG) Night: 100-12800 (Normal) Photo 12 MP: 100-6400 48 MP: 100-3200
Shutter Speed	12MP Photo: 1/16000-2 s (2.5-8 s for simulated long exposure) 48MP Photo: 1/8000-2 s
Max Image Size	8064×6048
Still Photography Modes	Single Shot: 12 MP and 48 MP Burst Shooting: 12 MP, 3/5/7 frames 48 MP, 3 frames Automatic Exposure Bracketing (AEB): 12 MP, 3/5/7 frames at 0.7 EV step 48 MP, 3 frames at 0.7 EV step Timed: 12 MP, 2/3/5/7/10/15/20/30/60 s 48 MP, 5/7/10/15/20/30/60 s
Photo Format	JPEG/DNG (RAW)
Video Resolution	H.264/H.265 4K: 3840×2160@24/25/30/48/50/60/100*fps FHD: 1920×1080@24/25/30/48/50/60/100*/200*fps * Recording frame rates. The corresponding video plays as slow-motion video. * 4K/100fps resolution and HLG/D-Log M color mode only support H.265 coding.
Video Format	MP4 (MPEG-4 AVC/H.264, HEVC/H.265)
Max Video Bitrate	H.264/H.265: 150 Mbps
Supported File System	exFAT
Color Mode and Sampling Method	Normal: 8-bit 4:2:0 (H.264/H.265) HLG/D-Log M: 10-bit 4:2:0 (H.265)
Digital Zoom	12MP Photo: 1-2x 4K: 1-3x FHD: 1-4x

Gimbal	
Stabilization	3-axis mechanical gimbal (tilt, roll, pan)
Mechanical Range	Tilt: -135° to 80° Roll: -135° to 45° Pan: -30° to 30°
Controllable Range	Tilt: -90° to 60° Roll: -90° or 0°
Max Control Speed (tilt)	100°/s
Angular Vibration Range	±0.01°
Sensing	
Sensing Type	Omnidirectional binocular vision system, supplemented with a 3D infrared sensing system at the bottom of the aircraft
Forward	Measurement Range: 0.5-18 m Detection Range: 0.5-200 m Effective Sensing Speed: Flight Speed ≤ 12 m/s FOV: Horizontal 90°, Vertical 72°
Backward	Measurement Range: 0.5-15 m Effective Sensing Speed: Flight Speed ≤ 12 m/s FOV: Horizontal 90°, Vertical 72°
Lateral	Measurement Range: 0.5-12 m Effective Sensing Speed: Flight Speed ≤ 12 m/s FOV: Horizontal 90°, Vertical 72°
Upward	Measurement Range: 0.5-15 m Effective Sensing Speed: Flight Speed ≤ 5 m/s FOV: Front and Back 72°, Left and Right 90°
Downward	Measurement Range: 0.3-12 m Effective Sensing Speed: Flight Speed ≤ 5 m/s FOV: Front and Back 106°, Left and Right 90°
Operating Environment	Forward, Backward, Left, Right, and Upward: Surfaces with discernible patterns and adequate lighting (lux > 15) Downward: Surfaces with discernible patterns, diffuse reflectivity > 20% (e.g. walls, trees, people), and adequate lighting (lux > 15)
3D Infrared Sensor	Measurement Range: 0.1-8 m (reflectivity > 10%) FOV: Front and Back 60°, Left and Right 60°
Video Transmission	
Video Transmission System	O4

Live View Quality Remote Controller:
 Up to 1080p/60fps (available when the aircraft is flying in Photo or Video mode)
 Up to 1080p/30fps (available when the aircraft is flying in Video mode)
 Up to 1080p/24fps (available when the aircraft is in standby mode on the ground)

Operating Frequency^[6] 2.4000-2.4835 GHz, 5.170-5.250 GHz, 5.725-5.850 GHz

Transmitter Power (EIRP) 2.4 GHz: <33 dBm (FCC), <20 dBm (CE/SRRC/MIC)
 5.1 GHz: <23 dBm (CE)
 5.8 GHz: <33 dBm (FCC), <14 dBm (CE), <30 dBm (SRRC)

Max Transmission Distance (unobstructed, free of interference)^[7] 20 km (FCC), 10 km (CE/SRRC/MIC)

Max Transmission Distance (unobstructed, with interference)^[8] Strong Interference: urban landscape, approx. 1.5-4 km
 Medium Interference: suburban landscape, approx. 4-10 km
 Low Interference: suburb/seaside, approx. 10-20 km

Max Transmission Distance (obstructed, with interference)^[9] Low Interference and Obstructed by Buildings: approx. 0-0.5 km
 Low Interference and Obstructed by Trees: approx. 0.5-3 km

Max Download Speed **O4:**
 10 MB/s (with DJI RC-N2)
 10 MB/s (with DJI RC 2)

Wi-Fi 5: 30 MB/s*

* Measured in a laboratory environment with little interference in countries/regions that support both 2.4 GHz and 5.8 GHz, with footage saved to the internal storage. Download speeds may vary depending on the actual conditions.

Lowest Latency^[10] Aircraft + Remote Controller: approx. 120 ms

Antenna 4 antennas, 2T4R

Storage

Recommended microSD Cards SanDisk Extreme PRO 32GB V30 U3 A1 microSDHC
 Lexar 1066x 64GB V30 U3 A2 microSDXC
 Lexar 1066x 128GB V30 U3 A2 microSDXC
 Lexar 1066x 256GB V30 U3 A2 microSDXC
 Lexar 1066x 512GB V30 U3 A2 microSDXC
 Kingston Canvas GO! Plus 64GB V30 U3 A2 microSDXC
 Kingston Canvas GO! Plus 128GB V30 U3 A2 microSDXC
 Kingston Canvas React Plus 64GB V90 U3 A1 microSDXC
 Kingston Canvas React Plus 128GB V90 U3 A1 microSDXC
 Kingston Canvas React Plus 256GB V90 U3 A1 microSDXC
 Samsung EVO Plus 512GB V30 U3 A2 microSDXC

Intelligent Flight Battery

Compatible Battery	DJI Mini 4 Pro Intelligent Flight Battery DJI Mini 3 Series Intelligent Flight Battery Plus
Capacity	Intelligent Flight Battery: 2590 mAh Intelligent Flight Battery Plus: 3850 mAh
Weight	Intelligent Flight Battery: approx. 77.9 g Intelligent Flight Battery Plus: approx. 121 g
Nominal Voltage	Intelligent Flight Battery: 7.32 V Intelligent Flight Battery Plus: 7.38 V
Max Charging Voltage	Intelligent Flight Battery: 8.6 V Intelligent Flight Battery Plus: 8.5 V
Type	Li-ion
Chemical System	LiNiMnCoO ₂
Energy	Intelligent Flight Battery: 18.96 Wh Intelligent Flight Battery Plus: 28.4 Wh
Charging Temperature	5° to 40° C (41° to 104° F)
Charging Time	<p>Intelligent Flight Battery: 70 minutes (with the DJI 30W USB-C Charger and the battery mounted to the aircraft) 58 minutes (with the DJI 30W USB-C Charger and the battery inserted into the Two-Way Charging Hub)</p> <p>Intelligent Flight Battery Plus: 101 minutes (with the DJI 30W USB-C Charger and the battery mounted to the aircraft) 78 minutes (with the DJI 30W USB-C Charger and the battery inserted into the Two-Way Charging Hub)</p>

Charger

Recommended Charger	DJI 30W USB-C Charger or other USB Power Delivery chargers (30 W)* * When you charge the battery mounted to the aircraft or inserted into the Two-Way Charging Hub, the maximum charging power supported is 30 W.
---------------------	--

Charging Hub

Input	5 V, 3 A 9 V, 3 A 12 V, 3 A
Output	USB-A: Max Voltage: 5 V; Max Current: 2 A
Compatibility	DJI Mini 4 Pro Intelligent Flight Battery DJI Mini 3 Series Intelligent Flight Battery/Intelligent Flight Battery Plus

DJI RC 2 Remote Controller (Model: RC331)

Max Operating Time	3 hours
Operating Temperature	-10° to 40° C (14° to 104° F)

Charging Temperature	5° to 40° C (41° to 104° F)
Charging Time	1.5 hours
Charging Type	Supports up to 9V/3A charging
Battery Capacity	22.32 Wh (3.6 V, 3100 mAh×2)
Battery Type	18650 Li-ion
Chemical System	LiNiMnCoO ₂
GNSS	GPS + Galileo + BeiDou
Internal Storage Capacity	32 GB + expandable storage (via microSD card)
Supported SD Cards	UHS-I Speed Grade 3 rating microSD card or above
Screen Brightness	700 nits
Screen Resolution	1920×1080
Screen Size	5.5-inch
Screen Frame Rate	60 fps
Touchscreen Control	10-point multi-touch
Dimensions	Without control sticks: 168.4×132.5×46.2 mm With control sticks: 168.4×132.5×62.7 mm
Weight	Approx. 420 g

Video Transmission

Antennas	4 antennas, 2T4R
Operating Frequency ^[6]	2.4000-2.4835 GHz, 5.170-5.250 GHz, 5.725-5.850 GHz
Transmitter Power (EIRP)	2.4 GHz: <33 dBm (FCC), <20 dBm (CE/SRRC/MIC) 5.1 GHz: <23 dBm (CE) 5.8 GHz: <33 dBm (FCC), <14 dBm (CE), <30 dBm (SRRC)

Wi-Fi

Protocol	802.11 a/b/g/n/ac/ax
Operating Frequency ^[6]	2.4000-2.4835 GHz, 5.150-5.250 GHz, 5.725-5.850 GHz
Transmitter Power (EIRP)	2.4 GHz: <26 dBm (FCC), <20 dBm (CE/SRRC/MIC) 5.1 GHz: <23 dBm (FCC/CE/SRRC/MIC) 5.8 GHz: <23 dBm (FCC/SRRC), <14 dBm (CE)

Bluetooth

Protocol	Bluetooth5.2
Operating Frequency	2.4000-2.4835 GHz
Transmitter Power (EIRP)	<10 dBm

DJI RC-N2 Remote Controller (Model: RC151)

Max Operating Time	Without charging any mobile device: 6 hours When charging a mobile device: 3.5 hours
--------------------	---

Max Supported Mobile Device Size	180×86×10 mm
Operating Temperature	-10° to 40° C (14° to 104° F)
Charging Temperature	5° to 40° C (41° to 104° F)
Charging Time	2.5 hours
Charging Type	It is recommended to use a 5V/2A charger.
Battery Capacity	18.72 Wh (3.6 V, 2600 mAh × 2)
Battery Type	18650 Li-ion
Dimensions	104.22×149.95×45.25 mm
Weight	375 g
Supported Mobile Device Port Type	Lightning, USB-C, Micro-USB * Using a mobile device with Micro-USB port requires the DJI RC-N1 RC Cable (Standard Micro USB connector), which is sold separately.

Video Transmission	
Operating Frequency ^[6]	2.4000-2.4835 GHz, 5.170-5.250 GHz, 5.725-5.850 GHz
Transmitter Power (EIRP)	2.4 GHz: <33 dBm (FCC), <20 dBm (CE/SRRC/MIC) 5.1 GHz: <23 dBm (CE) 5.8 GHz: <33 dBm (FCC), <14 dBm (CE), <30 dBm (SRRC)

- [1] Standard aircraft weight (including the Intelligent Flight Battery, propellers, and a microSD card). The actual product weight may vary due to differences in batch materials and external factors. Registration is not required in some countries and regions. Always check local laws and regulations before use. With the Intelligent Flight Battery Plus (sold separately and only in select countries), the aircraft will weigh more than 249 g. Always check and strictly abide by local laws and regulations before flying.
- [2] The max horizontal speed is subject to dynamic local restrictions. Always abide by local laws and regulations when flying.
- [3] Increase in aircraft weight can affect flight propulsion. When the aircraft is using the Intelligent Flight Battery Plus, do not mount additional payloads like a propeller guard or third-party accessories to avoid diminished propulsion.
- [4] Measured in a controlled test environment. Specific test conditions are as follows: flying forward at a constant speed of 21.6 kph in a windless laboratory environment at 20 meters above sea level, in photo mode (without photo taking operation during flight), with Obstacle Avoidance Action set to Off, and from 100% battery level until 0%. Results may vary depending on the environment, actual use, and firmware version.
- [5] Measured in a controlled test environment. Specific test conditions are as follows: hovering in a windless laboratory environment at 20 meters above sea level, in photo mode (without photo taking operation during flight), with Obstacle Avoidance Action set to Off, and from 100% battery charge until 0%. Results may vary depending on the environment, actual use, and firmware version.
- [6] In some countries and regions, the 5.8 and 5.1GHz frequencies are prohibited, or the 5.1GHz frequency is only allowed for indoor use. Check local laws and regulations for more information.
- [7] Measured in an unobstructed outdoor environment free of interference. The above data shows the farthest communication range for one-way, non-return flights under each standard. Always pay attention to RTH reminders in the DJI Fly app during your flight.
- [8] Data tested under FCC standard in unobstructed environments with typical interference. Used for reference purposes only and provides no guarantee for actual transmission distance.
- [9] Data tested under FCC standard in obstructed environments with typical low interference. Used for reference purposes only and provides no guarantee for actual transmission distance.
- [10] Depending on the actual environment and mobile device.



- The photos taken in Single Shot mode have no HDR effect in the following situations:
 - a. When the aircraft is moving or unstable due to high wind speeds.
 - b. When white balance is set to manual mode.
 - c. The camera is in Auto mode and the EV setting is adjusted manually.
 - d. The camera is in Auto mode and the AE lock is turned on.
 - e. The camera is in Pro mode.
- DJI Mini 4 Pro doesn't include a built-in fan, which effectively reduces the aircraft's weight and increases the battery life. Meanwhile, it uses the wind generated by the propellers to dissipate heat during the flight, ensuring heat dissipation to prevent overheating. When DJI Mini 4 Pro stays in standby mode for a long time, its temperature may continuously rise. The aircraft has a built-in temperature control system, when in standby mode the aircraft can make intelligent judgments based on the current temperature to better reduce the temperature. DJI Mini 4 Pro is added with an energy-saving mode. When the temperature of the aircraft rises to a certain temperature, the aircraft will enter the energy-saving mode. If the temperature of the aircraft continues to rise, it will power off to prevent overheating.

You can see whether the aircraft is in energy-saving mode by the prompts in the aircraft system status bar. Exit this mode by the following methods:

- a. Tap settings in DJI Fly, and exit the energy-saving mode according to the prompt.
- b. Start motors using the remote controller to exit the energy-saving mode.

In energy-saving mode, the user can only take photos and record videos, settings and functions about flight are unavailable. Operate based on the prompts in DJI Fly.

Firmware Update

Use DJI Fly or DJI Assistant 2 (Consumer Drones Series) to update the aircraft and the remote controller firmware.

Using DJI Fly

When connecting the aircraft or remote controller to DJI Fly, you will be notified if a new firmware update is available. To start updating, connect your remote controller or mobile device to the internet and follow the on-screen instructions. Note that you cannot update the firmware if the remote controller is not linked to the aircraft. An internet connection is required.

Using DJI Assistant 2 (Consumer Drones Series)

Use DJI Assistant 2 (Consumer Drones Series) to update the aircraft and the remote controller separately.

1. Power on the device. Connect the device to a computer with a USB-C cable.
2. Launch DJI Assistant 2 (Consumer Drones Series) and log in with your DJI account.
3. Select the device and click Firmware Update on the left side of the screen.
4. Select the firmware version.
5. Wait for the firmware to download. The firmware update will start automatically.
6. Wait for the firmware update to complete.

-
-  • The battery firmware is included in the aircraft firmware. Be sure to update all batteries.
- Make sure to follow all the steps to update the firmware, otherwise the update may fail.
 - Make sure the computer is connected to the internet during the update.
 - DO NOT unplug the USB-C cable during an update.
 - Before performing an update, make sure the Intelligent Flight Battery is at least 40% charged and the remote controller is at least 20% charged.
 - The firmware update will take approximately 10 minutes. During the update process, it is normal for the gimbal to go limp, the aircraft status indicators to blink, and the aircraft to reboot. Wait patiently for the update to complete.
-

Maintenance Instructions

To avoid serious injury to children and animals, observe the following rule:

1. Small parts, such as cables and straps, are dangerous if swallowed. Keep all parts out of reach of children and animals.
2. Store the Intelligent Flight Battery and remote controller in a cool, dry place away from direct sunlight to ensure the built-in LiPo battery does NOT overheat. Recommended storage temperature: between 22° and 28° C (71° and 82° F) for storage periods of more than three months. Never store in environments outside the temperature range of 14° to 113° F (-10° to 45° C).

3. DO NOT allow the camera to come into contact with or become immersed in water or other liquids. If it gets wet, wipe dry with a soft, absorbent cloth. Turning on an aircraft that has fallen in water may cause permanent component damage. DO NOT use substances containing alcohol, benzene, thinners, or other flammable substances to clean or maintain the camera. DO NOT store the camera in humid or dusty areas.
4. DO NOT connect this product to any USB interface older than version 3.0. DO NOT connect this product to any "power USB" or similar devices.
5. Check every aircraft part after any crash or serious impact. If there are any problems or questions, contact a DJI authorized dealer.
6. Regularly check the Battery Level Indicators to see the current battery level and overall battery life. The battery is rated for 200 cycles. It is not recommended to continue use afterward.
7. Post-Flight Checklist
 - a. Make sure the Intelligent Flight Battery and the propellers are in good condition.
 - b. Make sure that the camera lens and Vision System sensors are clean.
 - c. Make sure to attach the gimbal protector before storing or transporting the aircraft.
8. Make sure to transport the aircraft with the arms folded when powered off.
9. Make sure to transport the remote controller with antennas folded when powered off.
10. The battery will enter sleep mode after long-term storage. Charge the battery to exit from sleep mode.
11. Use the ND filter if the exposure time needs to be prolonged. Refer to the product information on how to install the ND filters.
12. Store the aircraft, remote controller, battery, and charger in a dry environment. It is recommended to store and transport the product in an environment with an ambient temperature of 15° to 25° C and a humidity of about 40%. There is no special requirement for altitude during transportation or storage.
13. Remove the battery before servicing the aircraft (e.g., cleaning or attaching and detaching the propellers). Make sure that the aircraft and the propellers are clean by removing any dirt or dust with a soft cloth. Do not clean the aircraft with a wet cloth or use a cleanser that contains alcohol. Liquids can penetrate the aircraft housing, which can cause a short circuit and destroy the electronics.
14. Make sure to turn off the battery to replace or to check the propellers.

Troubleshooting Procedures

1. Why can the battery not be used before the first flight?

The battery must be activated by charging before using it for the first time.
2. How to solve the gimbal drift issue during flight?

Calibrate IMU and compass in DJI Fly. If the problem persists, contact DJI Support.
3. No function

Check if the Intelligent Flight battery and the remote controller are activated by charging. If the problems persist, contact DJI support.

4. Power-on and start-up problems

Check if the battery has power. If yes, contact DJI support if it cannot be started normally.

5. SW update issues

Follow the instructions in the user manual to update the firmware. If the firmware update fails, restart all the devices and try again. If the problem persists, contact DJI support.

6. Procedures to reset to factory default or last known working configuration

Use the DJI Fly app to reset to factory default.

7. Shutdown and power-off problems

Contact DJI support.

8. How to detect careless handling or storage in unsafe conditions

Contact DJI support.

Risk and Warnings

When the aircraft detects a risk after powering on, there will be a warning prompt on DJI Fly.

Pay attention to the list of situations below.

1. If the location is not suitable for takeoff.
2. If an obstacle is detected during flight.
3. If the location is not suitable for landing.
4. If the compass and IMU experience interference and need to be calibrated.
5. Follow the on-screen instructions when prompted.

Disposal



Observe the local regulations related to electronic devices when disposing of the aircraft and remote controller.

Battery Disposal

Dispose of the batteries in specific recycling containers only after a complete discharge. DO NOT dispose of the batteries in regular trash containers. Strictly follow the local regulations regarding the disposal and recycling of batteries.

Dispose of a battery immediately if it cannot be powered on after over-discharging.

If the power on/off button on the Intelligent Flight Battery is disabled and the battery cannot be fully discharged, contact a professional battery disposal/recycling agency for further assistance.

C0 Certification

DJI Mini 4 Pro (Model: MT4MFVD) is compliant with the requirements of C0 certification. There are some requirements and restrictions when using DJI Mini 4 Pro in European Economic Area (EEA, i.e. EU plus Norway, Iceland and Liechtenstein). DJI Mini 4 Pro and its similar products can be distinguished by the model number.

UAS Class	C0
Maximum Propeller Speed	10700 RPM

MTOM Statement

DJI Mini 4 Pro is a quadrotor aircraft. The MTOM of DJI Mini 4 Pro (Model: MT4MFVD) is 249 g, which is compliant with the requirements of C0 certification.

Users must follow the instructions below to comply with the MTOM C0 requirements.

Otherwise, the aircraft cannot be used as a C0 aircraft:

1. DO NOT add any payload to the aircraft except the items listed in the List of Items including qualified accessories section.
2. DO NOT use any non-qualified replacement parts, such as intelligent flight batteries or propellers, etc.
3. DO NOT retrofit the aircraft.

-  • The prompt "Low Battery RTH" will not appear in case of a horizontal distance between the pilot and aircraft is lower than 5 m.
- FocusTrack will exit automatically if the horizontal distance between the subject and the aircraft is further than 50 m (when using FocusTrack in the EU).

List of Items Including Qualified Accessories

Item	Model Number	Dimensions	Weight
DJI Mini 3 Pro Propellers	MT3M3VD-PPS	152.4 × 76.2 mm (Diameter × Thread Pitch)	0.9 g (each piece)
DJI Mini 4 Pro Intelligent Flight Battery	BWX140-2590-7.32	85 × 54 × 30 mm	Approx. 77.9 g
DJI Mini 4 Pro ND Filters Set (ND 16/64/256)*	MT4MFVD-NDFS	22 × 17 × 4 mm	0.65 g (Individual)
DJI Mini 4 Pro Wide-Angle Lens*	MT4MFVD-WAL	22 × 17 × 9 mm	2.25 g
microSD Card*	N/A	15 × 11 × 1.0 mm	Approx. 0.3 g

* Not included in the original package.

For how to install and use the ND Filters Set and the Wide-Angle Lens, refer to the Product Information for the two accessories respectively.

List of Spare and Replacement Parts

1. DJI Mini 3 Pro Propellers
2. DJI Mini 4 Pro Intelligent Flight Battery

EASA Notice

Make sure to read the Drone Information Notices document included in the package before use.

Visit the link below for more EASA notice information on traceability.

<https://www.easa.europa.eu/en/document-library/general-publications/drones-information-notices>

Original Instructions

This manual is provided by SZ DJI Technology, Inc., and the content is subject to change.

Address: Lobby of T2, DJI Sky City, No. 53 Xianyuan Road, Xili Community, Xili Street, Nanshan District, Shenzhen, China, 518055.

FAR Remote ID Compliance Information

The aircraft complies with the requirements of 14 CFR Part 89:

- The aircraft automatically broadcasts Remote ID messages from takeoff to shut down. An external device such as a cell phone or tablet is required to be connected as a location source to DJI mobile devices without an integrated GNSS system ^[1], and must run the DJI flight control app such as DJI Fly in the foreground and always allow the DJI flight control app to obtain its accurate location information. The connected external device must minimally be one of the following:
 - 1) FCC Certified personal wireless device that uses GPS with SBAS (WAAS) for location services; or
 - 2) FCC Certified personal wireless device with integrated GNSS.

Also, the external device must be operated in a way that does not interfere with the location reported and its correlation to the operator location.

- The aircraft automatically initiates a pre-flight self-test (PFST) of the Remote ID system before takeoff and cannot take off if it does not pass the PFST ^[2]. The results of the PFST of the Remote ID system can be viewed in either a DJI flight control app such as DJI Fly or DJI goggles.
- The aircraft monitors the Remote ID system functionality from pre-flight to shut down. If the Remote ID system malfunctions or has a failure, an alarm will be displayed in either a DJI flight control app such as DJI Fly or DJI goggles.

Footnotes

[1] DJI mobile devices without an integrated GNSS system such as DJI RC-N2.

[2] The pass criterion for PFST is that the hardware and software of the Remote ID required-data source and radio transmitter in the Remote ID system are functioning properly.

Aftersales Information

Visit <https://www.dji.com/support> to learn more about aftersales service policies, repair services, and support.

WE ARE HERE FOR YOU



Contact
DJI SUPPORT

This content is subject to change.



<https://www.dji.com/mini-4-pro/downloads>

If you have any questions about this document, please contact DJI by sending a message to DocSupport@dji.com.

DJI is a trademark of DJI.
Copyright © 2023 DJI All Rights Reserved.