



# Trimble T100 Tablet

## USER GUIDE

Model: 121800  
Version 1.00  
Revision B  
April 2021

## Corporate Office

Trimble Inc.  
935 Stewart Drive  
Sunnyvale, CA 94085  
USA

## Trimble Inc. USA

4450 Gibson Drive  
Tipp City  
Ohio 45371  
USA

## Trimble Inc. Europe

Box 64  
SE-182 11  
Danderyd  
Sweden

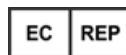

[www.trimble.com](http://www.trimble.com)

## Global technical support

To request detailed technical assistance for Trimble solutions, contact: [trimble\\_support@trimble.com](mailto:trimble_support@trimble.com)

## Copyright and trademarks

©2021, Trimble Inc. All rights reserved. Trimble and the Globe & Triangle logo are trademarks of Trimble Inc., registered in the United States and in other countries. Microsoft and Windows are either registered trademarks or trademarks of Microsoft Corporation in the United States and/or other countries. The Bluetooth word mark and logos are owned by the Bluetooth SIG, Inc. and any use of such marks by Trimble Inc. is under license. All other trademarks are the property of their respective owners.

## Release Notice

This is the April 2021 release (Revision B) of the Trimble T100 tablet documentation.

## Recycling information

You should dispose of the tablet computer and accessories properly according to local laws and regulations. Because this product contains electronic components, it must be disposed of separately from household waste. When the product reaches its end of life, contact your local Trimble reseller to learn about disposal and recycling options for your area.

### Recycling in Europe

The symbol at right means that according to local laws and regulations your product and/or its battery shall be disposed of separately from household waste. When this product reaches its end of life, take it to a collection point designated by local authorities. The separate collection and recycling of your product and/or its battery at the time of disposal will help conserve natural resources and ensure that it is recycled in a manner that protects human health and the environment.



For information about recycling Trimble WEEE (Waste Electrical and Electronic Equipment) products that run on electrical power go to [http://www.trimble.com/Corporate/Environmental\\_Compliance.aspx](http://www.trimble.com/Corporate/Environmental_Compliance.aspx).

To recycle Trimble WEEE products call +31 497 53 24 30, and ask for the "WEEE Associate". or mail a request for recycling instructions to:

Trimble Europe B.V. & Trimble International B.V.  
Industrieweg 187a  
5683 CC Best  
The Netherlands

### Taiwan – Battery Recycling Requirements

The product contains a Lithium-ion battery. Taiwanese regulations require that waste batteries are recycled.

廢電池請回收

Battery (電池可拆換時要求要放):



**CAUTION** : RISK OF EXPLOSION IF BATTERY IS REPLACED BY AN INCORRECT TYPE.

DISPOSE OF USED BATTERIES ACCORDING TO THE INSTRUCTIONS.

## Product Antenna and Gain - Table 1

List of antenna information	Gain				
	Components	Frequency (MHz)	Antenna type	Brand	Main
WLAN	2412-2462	FPC-PIFA	Trimble	-2.0 dBi	-0.9 dBi
Bluetooth	2402-2480	FPC-PIFA	Trimble	-2.0 dBi	-0.9 dBi

## Regional compliance

### Australia and New Zealand

This product conforms with the regulatory requirements of the Australian Communications and Media Authority (ACMA) Telecommunications, Radiocommunications and EMC Labelling Notices, thus satisfying the requirements for RCM marking and sale within Australia and New Zealand.



### Europe

This device complies with Directive 2014/53/EU issued by the Commission of the European Community.

There is no minimum separation distance required between the user's body and the device, including the antenna during body-worn operation to comply with the RF exposure requirements in Europe.

#### Frequency bands and Powers

- Frequency band(s) in which the radio equipment operates; see [Product Antenna and Gain - Table 1](#)
- Maximum radio-frequency power transmitted in the frequency band(s) in which the radio equipment operates: see [Product Antenna and Gain - Table 1](#)

#### Components and accessories

Accessories and components including software which allow the radio equipment to operate as intended.

Manufacturers only have to describe those accessories and components including software if they:

- have an influence on the conformity of the radio equipment, and
- are intended to be installed or changed by the user without the control of the manufacturer.

The instructions shall also include information required as above.

Accessories example:

If the radio equipment is delivered without an antenna, then the technical features of the antenna that may be used in conjunction with the radio equipment shall be provided to the user. This information could be the generic characteristics of a given antenna type or a reference to a specific antenna(s) available on the market.

**Charging temperature:** 0 °C to +45 °C ( 32 °F to 113 °F)

**Battery temperature range:** -20 °C to +55 °C (-4 °F to 131 °F)

Manufacturer's Name: Trimble Inc.

Manufacturer's Address: 4408 Gibson Dr, Tipp City, OH 45371

Declares, under our sole responsibility, that the product:

Product Name: T100 Tablet

Model Number(s): 121800

Spectrum and maximum power: see [Product Antenna and Gain - Table 1](#)

In all cases assessment of the final product must be compliance with the Essential Requirements of the RED Directive 2014/53/EU LVD 2014/35/EU EMC 2014/53/EU RED Articles 3.1(a) and (b), safety and EMC respectively, as well as any relevant Article 3.2 requirements. An up to date DoC is available upon request or can be found at [trimble.com](http://trimble.com).

## Importer of Record

Trimble European Regional Fulfillment Center  
Logistics Manager  
Trimble Europe B.V. & Trimble International B.V.  
Industrieweg 187a  
5683 CC Best  
The Netherlands

## Trimble EC

Trimble Germany  
Am Prime Parc 11  
65479 Raunheim  
Germany

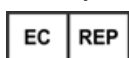

---

**CAUTION:** Only approved accessories may be used with this equipment. In general, all cables must be high quality, shielded, correctly terminated and normally restricted to two meters in length. Power supplies approved for this product employ special provisions to avoid radio interference and should not be altered or substituted. Unapproved modifications or operations beyond or in conflict with these instructions for use may void authorization by the authorities to operate the equipment.

---

## Canada

Contains IC: 1000M-9560NG  
Contains IC: 5817A-EM7565

## Product Antenna and Gain

RSS-GEN section 8.3

This radio transmitter has been approved by Industry Canada to operate with the antenna types listed below with the maximum permissible gain indicated. Antenna types not included in this list, having a gain greater than the maximum gain indicated for that type, are strictly prohibited for use with this device.

Cet émetteur radio (identifier l'appareil par numéro de certification) a été approuvé par l'industrie Canada pour fonctionner avec les types d'antenne énumérés ci-dessous avec le gain maximum admissible indiqué. Types d'antennes non inclus dans cette liste, ayant un gain supérieur au gain maximum indiqué pour cette type, sont strictement interdits pour une utilisation avec cet appareil.

see [Product Antenna and Gain - Table 1](#)

## Industry Canada statement

- 1 This device complies with Industry Canada license-exempt RSS standard(s). Operation is subject to the following two conditions: 1) this device may not cause interference, and 2) this device must accept any interference, including interference that may cause undesired operation of the device.

Le présent appareil est conforme aux CNR d'Industrie Canada applicables aux appareils radio exempts de licence. L'exploitation est autorisée aux deux conditions suivantes: 1) l'appareil ne doit pas produire de brouillage, et 2) l'utilisateur de l'appareil doit accepter tout brouillage radioélectrique subi, même si le brouillage est susceptible d'en compromettre le fonctionnement.

- 2 This Class B digital apparatus complies with Canadian ICES-003

Cet appareil numérique de la classe B est conforme à la norme NMB-003 du Canada.

- 3 This device complies with RSS-310 of Industry Canada. Operation is subject to the condition that this device does not cause harmful interference

Cet appareil est conforme à la norme RSS-310 d'Industrie Canada. L'opération est soumise à la condition que cet appareil ne provoque aucune interférence nuisible

- 4 This device and its antenna(s) must not be co-located or operating in conjunction with any other antenna or transmitter, except tested built-in radios

Cet appareil et son antenne ne doivent pas être situés ou fonctionner en conjonction avec une autre antenne ou un autre émetteur, exception faites des radios intégrées qui ont été testées.

- 5 The County Code Selection feature is disabled for products marketed in the U.S./ Canada.

La fonction de sélection de l'indicatif du pays est désactivée pour les produits commercialisés aux États-Unis et au Canada.

#### FOR PORTABLE DEVICE (<20 cm from body / SAR needed)

Radiation Exposure Statement: The product complies with the Canada portable RF exposure limit set forth for an uncontrolled environment and is safe for intended operation as described in this manual. Further RF exposure reduction can be achieved if the product can be kept as far as possible from the user's body, or set the device to lower output power if such a function is available.

For devices that SAR tested with distance: This device has been tested for compliance with IC SAR values at a typical operating near the body. To ensure that RF exposure levels below the levels tested, use accessories with this equipment to maintain a minimum separation distance of 0 cm between the body of the user and the device. These accessories should not contain metallic components. It is possible that accessories used close to the body that do not meet these requirements are not consistent with the SAR limits and it is advisable to avoid using them.

Déclaration d'exposition aux radiations: Le produit est conforme aux limites d'exposition pour les appareils portables RF pour les Etats-Unis et le Canada établies pour un environnement non contrôlé. Le produit est sûr pour un fonctionnement tel que décrit dans ce manuel. La réduction aux expositions RF peut être augmentée si l'appareil peut être conservé aussi loin que possible du corps de l'utilisateur ou que le dispositif est réglé sur la puissance de sortie la plus faible si une telle fonction est disponible.

Pour les appareils testés par SAR à distance Ce dispositif a été testé pour la conformité avec les valeurs SAR à un fonctionnement typique près du corps . Pour assurer que les niveaux d'exposition aux radiofréquences en deçà des niveaux testés , utiliser des accessoires avec cet équipement pour maintenir une distance de séparation minimale de 0 cm entre le corps de l'utilisateur et l'appareil. Ces accessoires ne doivent pas contenir des composants métalliques . Il est possible que les accessoires utilisés près du corps qui ne répondent pas à ces exigences ne sont pas compatibles avec les limites SAR et il est conseillé d'éviter de les utiliser.

OR

#### FOR WLAN 5GHZ DEVICE:

##### CAUTION:

- i. the device for operation in the band 5150–5250 MHz is only for indoor use to reduce the potential for harmful interference to co-channel mobile satellite systems;
- ii. for devices with detachable antenna(s),the maximum antenna gain permitted for devices in the bands 5250-5350 MHz and 5470-5725 MHz shall be such that the equipment still complies with the e.i.r.p. limit
- iii. for devices with detachable antenna(s),the maximum antenna gain permitted for devices in the band 5725-5850 MHz shall be such that the equipment still complies with the e.i.r.p. limits as appropriate;
- iv. where applicable, antenna type(s), antenna models(s), and worst-case tilt angle(s) necessary to remain compliant with the e.i.r.p. elevation mask requirement set forth in section 6.2.2.3 shall be clearly indicated. <for 5G B2 with DFS band, EIRP > 200 mW>

##### AVERTISSEMENT:

- i. les dispositifs fonctionnant dans la bande de 5 150 à 5 250 MHz sont réservés uniquement pour une utilisation à l'intérieur afin de réduire les risques de brouillage préjudiciable aux systèmes de satellites mobiles utilisant les mêmes canaux

- 
- ii. pour les dispositifs munis d'antennes amovibles, le gain maximal d'antenne permis pour les dispositifs utilisant les bandes de 5 250 à 5 350 MHz et de 5 470 à 5 725 MHz doit être conforme à la limite de la p.i.r.e.;
  - iii. Pour les dispositifs munis d'antennes amovibles, le gain maximal d'antenne permis (pour les dispositifs utilisant la bande de 5 725 à 5 850 MHz) doit être conforme à la limite de la p.i.r.e. spécifiée, selon le cas;
  - iv. lorsqu'il y a lieu, les types d'antennes (s'il y en a plusieurs), les numéros de modèle de l'antenne et les pires angles d'inclinaison nécessaires pour rester conforme à l'exigence de la p.i.r.e. applicable au masque d'élévation, énoncée à la section 6.2.2.3, doivent être clairement indiqués. <for 5G B2 with DFS band, EIRP > 200 mW>
- 

## U.S.

Contains FCC ID: PD99560NG

Contains FCC ID: S9E-EM7565

### Federal Communication Commission Interference Statement

This device complies with Part 15 of the FCC Rules. Operation is subject to the following two conditions: (1) This device may not cause harmful interference, and (2) this device must accept any interference received, including interference that may cause undesired operation.

This equipment has been tested and found to comply with the limits for a Class B digital device, pursuant to Part 15 of the FCC Rules. These limits are designed to provide reasonable protection against harmful interference in a residential installation. This equipment generates, uses and can radiate radio frequency energy and, if not installed and used in accordance with the instructions, may cause harmful interference to radio communications. However, there is no guarantee that interference will not occur in a particular installation. If this equipment does cause harmful interference to radio or television reception, which can be determined by turning the equipment off and on, the user is encouraged to try to correct the interference by one of the following measures:

- Reorient or relocate the receiving antenna.
- Increase the separation between the equipment and receiver.
- Connect the equipment into an outlet on a circuit different from that to which the receiver is connected. -Consult the dealer or an experienced radio/TV technician for help.

### FCC Caution:

- Any changes or modifications not expressly approved by the party responsible for compliance could void the user's authority to operate this equipment.
- This transmitter must not be co-located or operating in conjunction with any other antenna or transmitter.

### FOR PORTABLE DEVICE USAGE (<20 cm from body / SAR needed)

**Radiation Exposure Statement:** This device meets the government's requirements for exposure to radio waves.

This device is designed and manufactured not to exceed the emission limits for exposure to radio frequency (RF) energy set by the Federal Communications Commission of the U.S. Government.

The exposure standard for wireless device employs a unit of measurement known as the Specific Absorption Rate, or SAR. The SAR limit set by the FCC is 1.6W/kg. \*Tests for SAR are conducted using standard operating positions accepted by the FCC with the device transmitting at its highest certified power level in all tested frequency bands.

### FOR COUNTRY CODE SELECTION USAGE (WLAN DEVICES)

Note: The country code selection is for non-U.S. model only and is not available to all U.S. model. Per FCC regulation, all Wi-Fi products marketed in the U.S. must be fixed to U.S. operation channels only.

## Limited Warranty Terms and Conditions

### Product Limited Warranty

Subject to the terms and conditions set forth herein, Trimble Inc. ("Trimble") warrants that for a period of two (2) years from date of purchase this Trimble product (the "Product") will substantially conform to Trimble's publicly available specifications for the Product and that the hardware and any storage media components of the Product will be substantially free from defects in materials and workmanship.

## Product Software

Product software, whether built into hardware circuitry as firmware, provided as a standalone computer software product, embedded in flash memory, or stored on magnetic or other media, is licensed solely for use with or as an integral part of the Product and is not sold. The terms of the end user license agreement, as included below, govern the use of the Product Software, including any differing limited warranty terms, exclusions and limitations, which shall control over the terms and conditions set forth in the limited Product warranty.

## Warranty Remedies

If the Trimble Product fails during the warranty period for reasons covered by this limited warranty and you notify Trimble of such failure during the warranty period, Trimble will repair OR replace the nonconforming Product with new, equivalent to new, or reconditioned parts or Product, OR refund the Product purchase price paid by you, at Trimble's option, upon your return of the Product in accordance with Trimble's product return procedures then in effect..

## How to Obtain Warranty Service

To obtain warranty service for the Product, it is recommended you contact your Trimble dealer. Alternatively, you may contact Trimble to request warranty service by emailing [Repair\\_Services@Trimble.com](mailto:Repair_Services@Trimble.com). Please be prepared to provide:

- your name, address, and telephone numbers;
- product name, part number and serial number;
- proof of purchase;
- an explanation of the problem.

The customer service representative may need additional information from you depending on the nature of the problem.

## Warranty Exclusions and Disclaimer

This Product limited warranty shall only apply in the event and to the extent that (i) the Product is properly and correctly installed, configured, interfaced, maintained, stored, and operated in accordance with Trimble's applicable operator's manual and specifications, and; (ii) the Product is not modified or misused. This Product limited warranty shall not apply to, and Trimble shall not be responsible for, defects or performance problems resulting from (i) the combination or utilization of the Product with hardware or software products, information, data, systems, interfaces, or devices not made, supplied, or specified by Trimble; (ii) the operation of the Product under any specification other than, or in addition to, Trimble's standard specifications for its products; (iii) the unauthorized installation, modification, or use of the Product; (iv) damage caused by: accident, lightning or other electrical discharge, fresh or salt water immersion or spray (outside of Product specifications); or exposure to environmental conditions for which the Product is not intended; (v) normal wear and tear on consumable parts (e.g., batteries); or (vi) cosmetic damage. Trimble does not warrant or guarantee the results obtained through the use of the Product or Software, or that software components will operate error free.

NOTICE REGARDING PRODUCTS EQUIPPED WITH TECHNOLOGY CAPABLE OF TRACKING SATELLITE SIGNALS FROM SATELLITE BASED AUGMENTATION SYSTEMS (SBAS) (WAAS, EGNOS, GAGAN, MSAS AND LUCH), OMNISTAR, BEIDOU, GPS, GALILEO OR GLONASS SATELLITES, OR FROM IALA BEACON SOURCES: TRIMBLE IS NOT RESPONSIBLE FOR THE OPERATION OR FAILURE OF OPERATION OF ANY SATELLITE BASED POSITIONING SYSTEM OR THE AVAILABILITY OF ANY SATELLITE BASED POSITIONING SIGNALS.

THE FOREGOING LIMITED WARRANTY TERMS STATE TRIMBLE'S ENTIRE LIABILITY, AND YOUR EXCLUSIVE REMEDIES, RELATING TO THE TRIMBLE PRODUCT. EXCEPT AS OTHERWISE EXPRESSLY PROVIDED HEREIN, THE PRODUCT, AND ACCOMPANYING DOCUMENTATION AND MATERIALS ARE PROVIDED "AS-IS" AND WITHOUT EXPRESS OR IMPLIED WARRANTY OF ANY KIND, BY EITHER TRIMBLE OR ANYONE WHO HAS BEEN INVOLVED IN ITS CREATION, PRODUCTION, INSTALLATION, OR DISTRIBUTION, INCLUDING, BUT NOT LIMITED TO, THE IMPLIED WARRANTIES OF MERCHANTABILITY AND FITNESS FOR A PARTICULAR PURPOSE, TITLE, AND NON-INFRINGEMENT. THE STATED EXPRESS WARRANTIES ARE IN LIEU OF ALL OBLIGATIONS OR LIABILITIES ON THE PART OF TRIMBLE ARISING OUT OF, OR IN CONNECTION WITH, ANY PRODUCT. BECAUSE SOME STATES AND JURISDICTIONS DO NOT ALLOW LIMITATIONS ON DURATION OR THE EXCLUSION OF AN IMPLIED WARRANTY, THE ABOVE LIMITATION MAY NOT APPLY TO YOU.

## Limitation of Liability

TRIMBLE'S ENTIRE LIABILITY UNDER ANY PROVISION HEREIN SHALL BE LIMITED TO THE AMOUNT PAID BY YOU FOR THE PRODUCT. TO THE MAXIMUM EXTENT PERMITTED BY APPLICABLE LAW, IN NO EVENT SHALL TRIMBLE OR ITS SUPPLIERS BE

LIABLE FOR ANY INDIRECT, SPECIAL, INCIDENTAL, OR CONSEQUENTIAL DAMAGE WHATSOEVER UNDER ANY CIRCUMSTANCE OR LEGAL THEORY RELATING IN ANYWAY TO THE PRODUCTS, SOFTWARE AND ACCOMPANYING DOCUMENTATION AND MATERIALS, (INCLUDING, WITHOUT LIMITATION, DAMAGES FOR LOSS OF BUSINESS PROFITS, BUSINESS INTERRUPTION, LOSS OF DATA, OR ANY OTHER PECUNIARY LOSS), REGARDLESS OF WHETHER TRIMBLE HAS BEEN ADVISED OF THE POSSIBILITY OF ANY SUCH LOSS AND REGARDLESS OF THE COURSE OF DEALING WHICH DEVELOPS OR HAS DEVELOPED BETWEEN YOU AND TRIMBLE. BECAUSE SOME STATES AND JURISDICTIONS DO NOT ALLOW THE EXCLUSION OR LIMITATION OF LIABILITY FOR CONSEQUENTIAL OR INCIDENTAL DAMAGES, THE ABOVE LIMITATION MAY NOT APPLY TO YOU.

NOTE: THE ABOVE TRIMBLE LIMITED WARRANTY PROVISIONS WILL NOT APPLY TO PRODUCTS PURCHASED IN THOSE JURISDICTIONS (E.G., MEMBER STATES OF THE EUROPEAN ECONOMIC AREA) IN WHICH PRODUCT WARRANTIES ARE THE RESPONSIBILITY OF THE LOCAL DEALER FROM WHOM THE PRODUCTS ARE ACQUIRED. IN SUCH A CASE, PLEASE CONTACT YOUR TRIMBLE DEALER FOR APPLICABLE WARRANTY INFORMATION.

### **Notice to Australian Purchasers - The Australian Consumer Law**

Our goods come with guarantees that cannot be excluded under the Australian Consumer Law. You are entitled to a replacement or refund for a major failure and for compensation for any other reasonably foreseeable loss or damage. You are also entitled to have the goods repaired or replaced if the goods fail to be of acceptable quality and the failure does not amount to a major failure.

Trimble's warranty, as set out in the user manual accompanying this statement, or as described in the warranty card accompanying the Product you purchased, is in addition to any mandatory rights and remedies that you may have under the Australian Consumer Law.

### **Official Language**

THE OFFICIAL LANGUAGE OF THESE TERMS AND CONDITIONS IS ENGLISH. IN THE EVENT OF A CONFLICT BETWEEN ENGLISH AND OTHER LANGUAGE VERSIONS, THE ENGLISH LANGUAGE SHALL CONTROL

### **End User License Agreement for Product Software**

IMPORTANT, READ CAREFULLY. THIS END USER LICENSE AGREEMENT ("EULA") IS A LEGAL AGREEMENT BETWEEN YOU AND Trimble Inc. ("Trimble") and applies to the computer software provided with the Trimble product purchased by you (whether built into hardware circuitry as firmware, embedded in flash memory, or stored on magnetic or other media), or provided as a stand-alone computer software product, and includes any accompanying written materials such as a user's guide or product manual, as well as any "online" or electronic documentation ("Software" or "Product Software"). This EULA will also apply to any Software error corrections, updates and upgrades subsequently furnished by Trimble, unless such are accompanied by different license terms and conditions, which will govern their use. You have acquired a Trimble Product ("Device") that includes Software, some of which was licensed by Trimble from Microsoft Corporation or its affiliates (collectively "Microsoft"). The Software licensed from Microsoft, as well as associated updates, supplements, internet-based services and support services, media, printed materials, and "online" or electronic documentation ("Microsoft Software"), are protected under this EULA. The Software is also protected by copyright laws and international copyright treaties, as well as other intellectual property laws and treaties. The Software is licensed, not sold.

BY USING THE SOFTWARE, INCLUDING USE ON THIS DEVICE, YOU ACCEPT THESE TERMS. IF YOU DO NOT ACCEPT THEM, DO NOT USE THE DEVICE OR SOFTWARE. INSTEAD CONTACT TRIMBLE FOR A REFUND OR CREDIT. As described below, using some features also operates as your consent to the transmission of certain standard computer information for Internet-based services.

---

**WARNING** - If the Software contains voice operated technologies, then operating this Software requires user attention. Diverting attention away from the road while driving can possibly cause an accident or other serious consequence. Even occasional, short diversions of attention can be dangerous if your attention is diverted away from your driving task at a critical time. Trimble and Microsoft make no representations, warranties or other determinations that ANY use of this Software is legal, safe, or in any manner recommended or intended while driving or otherwise operating a motor vehicle.

---

#### **1 LIMITED WARRANTY FOR TRIMBLE PRODUCT SOFTWARE**

1.1 Limited Warranty. Trimble warrants that the Software, exclusive of the Microsoft Software, will perform substantially in accordance with the accompanying written materials for a period of twelve (12) months from the date of purchase. This limited warranty gives you specific legal rights; you may have others, which vary from state/jurisdiction to state/jurisdiction. The above limited warranty does not apply to Fixes, Minor Updates, or Major Upgrades of the Software after expiration of the



twelve (12) month limited warranty period, all of which are provided "AS IS" and without warranty unless otherwise specified in writing by Trimble. Because the Software is inherently complex and may not be completely free of nonconformities, defects or errors, you are advised to verify your work. Trimble does not warrant that the Software will operate error free or uninterrupted, will meet your needs or expectations, or that all nonconformities can or will be corrected.

1.2 Software Fixes. During the limited warranty period described in section 1.1 above, you will be entitled to receive such Fixes to the Product Software that Trimble releases and makes commercially available and for which it does not charge separately, subject to the procedures for delivery to purchasers of Trimble products generally. If you have purchased the Product from an authorized Trimble dealer rather than from Trimble directly, Trimble may, at its option, forward the software Fix to the Trimble dealer for final distribution to you. Minor Updates, Major Upgrades, new products, or substantially new software releases, as identified by Trimble, are expressly excluded from this update process and limited warranty. Receipt of Software Fixes or other enhancements shall not serve to extend the limited warranty period.

For purposes of this warranty the following definitions shall apply: (1) "Fix(es)" means an error correction or other update created to fix a previous software version that does not substantially conform to its Trimble specifications; (2) "Minor Update" occurs when enhancements are made to current features in a software program; and (3) "Major Upgrade" occurs when significant new features are added to software, or when a new product containing new features replaces the further development of a current product line. Trimble reserves the right to determine, in its sole discretion, what constitutes a Fix, Minor Update, or Major Upgrade.

1.3 Customer Remedies. Trimble's and its suppliers' entire liability, and your sole remedy, with respect to the Software shall be either, at Trimble's option, (a) repair or replacement of the Software, or (b) return of the license fee paid for any Software that does not meet Trimble's limited warranty. This limited warranty is void if failure of the Software has resulted from (1) accident, misuse, abuse, or misapplication; (2) alteration or modification of the Software without Trimble's authorization; (3) interaction with software or hardware not supplied or supported by Trimble; (4) your improper, inadequate or unauthorized installation, maintenance or storage; or (5) if you violate the terms of this EULA. Any replacement Software will be warranted for the remainder of the original warranty period or thirty (30) days, whichever is longer.

1.4 NO OTHER WARRANTIES. TO THE MAXIMUM EXTENT PERMITTED BY APPLICABLE LAW, TRIMBLE AND ITS SUPPLIERS DISCLAIM ALL OTHER WARRANTIES, TERMS AND CONDITIONS, EITHER EXPRESS OR IMPLIED, BY STATUTE, COMMON LAW OR OTHERWISE, INCLUDING BUT NOT LIMITED TO, IMPLIED WARRANTIES, TERMS AND CONDITIONS OF MERCHANTABILITY AND FITNESS FOR A PARTICULAR PURPOSE, TITLE, AND NONINFRINGEMENT WITH REGARD TO THE SOFTWARE, ITS SATISFACTORY QUALITY AND THE PROVISION OF OR FAILURE TO PROVIDE SUPPORT SERVICES. TO THE EXTENT ALLOWED BY APPLICABLE LAW, IMPLIED WARRANTIES, TERMS AND CONDITIONS ON THE SOFTWARE ARE LIMITED TO NINETY (90) DAYS. YOU MAY HAVE OTHER LEGAL RIGHTS WHICH VARY FROM STATE/JURISDICTION TO STATE/JURISDICTION.

NO WARRANTIES FOR THE MICROSOFT SOFTWARE. THE MICROSOFT SOFTWARE is provided "AS IS" and with all faults, AND TRIMBLE PROVIDES NO WARRANTY WITH RESPECT THERETO. THE ENTIRE RISK AS TO SATISFACTORY QUALITY, PERFORMANCE,

ACCURACY AND EFFORT (INCLUDING LACK OF NEGLIGENCE) FOR THE MICROSOFT SOFTWARE IS WITH YOU. ALSO, THERE IS NO WARRANTY AGAINST INTERFERENCE WITH YOUR ENJOYMENT OF THE MICROSOFT SOFTWARE OR AGAINST INFRINGEMENT.

1.5 PLEASE NOTE: THE FOREGOING TRIMBLE LIMITED WARRANTY PROVISIONS MAY NOT APPLY TO SOFTWARE PRODUCT LICENSES PURCHASED IN THOSE JURISDICTIONS (SUCH AS COUNTRIES OF THE EUROPEAN UNION) IN WHICH PRODUCT WARRANTIES ARE OBTAINED FROM THE LOCAL DISTRIBUTOR. IN SUCH CASES, PLEASE CONTACT YOUR TRIMBLE DEALER FOR APPLICABLE WARRANTY INFORMATION.

## **2 TRIMBLE LIMITATION OF LIABILITY**

2.1 LIMITATION OF LIABILITY. TO THE MAXIMUM EXTENT PERMITTED BY APPLICABLE LAW, IN NO EVENT SHALL TRIMBLE OR ITS SUPPLIERS BE LIABLE FOR ANY SPECIAL, INCIDENTAL, INDIRECT, CONSEQUENTIAL OR PUNITIVE DAMAGES HOWEVER CAUSED AND REGARDLESS OF THE THEORY OF LIABILITY (INCLUDING, WITHOUT LIMITATION, DAMAGES FOR LOSS OF BUSINESS PROFITS, BUSINESS INTERRUPTION, LOSS OF BUSINESS INFORMATION, OR ANY OTHER PECUNIARY LOSS) ARISING OUT OF THE USE OR INABILITY TO USE THE SOFTWARE, OR THE PROVISION OF OR FAILURE TO PROVIDE SUPPORT SERVICES, EVEN IF TRIMBLE HAS BEEN ADVISED OF THE POSSIBILITY OF SUCH DAMAGES AND NOTWITHSTANDING ANY FAILURE OF ESSENTIAL PURPOSE OF ANY EXCLUSIVE REMEDY PROVIDED IN THIS EULA.

IN NO EVENT SHALL THE TOTAL CUMULATIVE LIABILITY OF TRIMBLE AND ITS SUPPLIERS IN CONNECTION WITH THIS EULA OR THE SOFTWARE, WHETHER BASED ON CONTRACT, WARRANTY, TORT (INCLUDING NEGLIGENCE), STRICT LIABILITY OR OTHERWISE, EXCEED THE ACTUAL AMOUNT PAID TO TRIMBLE FOR THE SOFTWARE LICENSE GIVING RISE TO THE CLAIM.

BECAUSE SOME STATES AND JURISDICTIONS DO NOT ALLOW THE EXCLUSION OR LIMITATION OF LIABILITY FOR CONSEQUENTIAL OR INCIDENTAL DAMAGES, THE ABOVE LIMITATION MAY NOT APPLY TO YOU.

### 3 GENERAL

3.1 This EULA shall be governed by the laws of the State of California and applicable United States Federal law without reference to "conflict of laws" principles or provisions. The United Nations Convention on Contracts for the International Sale of Goods will not apply to this EULA. Jurisdiction and venue of any dispute or court action arising from or related to this EULA or the Software shall lie exclusively in or be transferred to the courts the County of Santa Clara, California, and/or the United States District Court for the Northern District of California. You hereby consent and agree not to contest, such jurisdiction, venue and governing law.

3.2 Section 3.1 notwithstanding, if you acquired this product in Canada, this EULA is governed by the laws of the Province of Ontario, Canada. In such case each of the parties to this EULA irrevocably attorns to the jurisdiction of the courts of the Province of Ontario and further agrees to commence any litigation that may arise under this EULA in the courts located in the Judicial District of York, Province of Ontario. If you acquired this product in the European Union, this EULA is governed by the laws of The Netherlands, excluding its rules governing conflicts of laws and excluding the United Nations Convention on the International Sale of Goods. In such case each of the parties to this EULA irrevocably attorns to the jurisdiction of the courts of The Netherlands and further agrees to commence any litigation that may arise under this EULA in the courts of The Hague, The Netherlands.

3.3 Trimble reserves all rights not expressly granted by this EULA.

3.4 Official Language. The official language of this EULA and of any documents relating thereto is English. For purposes of interpretation, or in the event of a conflict between English and versions of this EULA or related documents in any other language, the English language version shall be controlling.

# Contents

<b>Safety information</b> .....	<b>14</b>
Battery safety .....	14
Power supply safety .....	15
Touchscreen glass .....	15
Service safety .....	15
Safe environments of use .....	16
Distraction .....	16
Telecommunications & Internet Association (TIA) .....	16
SAR .....	16
Caring for your device .....	17
Cleaning .....	17
Touchscreen care .....	17
Use and storage temperature .....	18
Product specifications .....	18
<b>1 Introduction</b> .....	<b>21</b>
Registration .....	21
Configuration options .....	22
In the box .....	22
Replacement and spare or optional accessories .....	22
Parts of the T100 tablet .....	23
<b>2 Basic setup and operation</b> .....	<b>24</b>
Installing a microSIM card and microSD card .....	24
Installing a screen protector .....	25
Charging and power modes .....	26
Charging the battery .....	26
Turning the device on .....	27
Power options .....	28
Sleep state .....	28
Restarting the device .....	28
Turning off the device .....	28
Checking the battery charge .....	29
Making your battery last longer .....	29
Using the touchscreen .....	30
Using the onscreen keypad .....	31
Using a USB or Bluetooth mouse and keyboard .....	31

Using the EMR stylus .....	31
Tethering and storing the stylus .....	32
Caring for the stylus .....	32
Using the tablet's keys .....	32
<b>3 Using the Windows 10 operating system .....</b>	<b>33</b>
Using accounts .....	33
Signing in .....	33
Signing out .....	34
Using the Start menu .....	34
Using the Action Center .....	34
Using the Windows Mobility Center .....	35
Using Task View and virtual desktops .....	35
Settings .....	36
Display settings: adjusting the backlight .....	36
Display settings: rotation lock .....	37
<b>4 Connecting to and using wireless networks .....</b>	<b>38</b>
Airplane mode .....	38
Working with Wi-Fi networks .....	39
Connecting to Wi-Fi .....	39
Disconnecting from a Wi-Fi network .....	39
Forgetting a Wi-Fi network .....	39
Working with cellular broadband .....	40
Connecting to cellular broadband .....	40
Locating the device's IMEI number .....	40
<b>5 Connecting to accessories and other devices .....</b>	<b>41</b>
Using the office stand .....	41
Mounting the tablet on a pole .....	41
Connecting to USB accessories .....	42
Connecting to Bluetooth accessories .....	42
Using Trimble EMPOWER modules .....	43
Installing EMPOWER modules .....	43
<b>6 Using the camera .....</b>	<b>44</b>
Taking photos and videos .....	44
Changing camera settings .....	44
Enable the Camera app to access your location to geo-tag photos .....	45
Viewing photos and videos .....	45

<b>7 Using the pre-installed apps</b> .....	<b>46</b>
Bundled Microsoft apps .....	46
Getting more apps .....	47
<b>8 Troubleshooting, downloading updates, and repair</b> .....	<b>48</b>
Troubleshooting .....	48
Further assistance and support with the Windows 10 Pro operating system .....	48
Performance issues .....	48
Wireless connectivity issues .....	49
Power and battery issues .....	50
Restarting or resetting the operating system .....	50
Operating system and software updates .....	52
Windows 10 updates .....	52
Software downloads and updates .....	52
Repairing your device .....	52

# Safety information

- ▶ Battery safety
- ▶ Power supply safety
- ▶ Touchscreen glass
- ▶ Service safety
- ▶ Safe environments of use
- ▶ Distraction
- ▶ Telecommunications & Internet Association (TIA)
- ▶ SAR
- ▶ Caring for your device
- ▶ Product specifications

Read this guide for important safety and health information and the terms of the Limited Warranty that apply to the Trimble® T100 tablet that you have purchased. Keep all printed guides for future reference. Failure to follow instructions and properly set up, use, and care for this product can increase the risk of serious injury or death, or damage the device or devices.

## Battery safety

Lithium-Ion batteries are classified by the U. S. Federal Government as non-hazardous waste and are safe for disposal in the normal municipal waste stream. These batteries contain recyclable materials and are accepted for recycling. Dispose of used batteries in accordance with local regulations.

---

 **WARNING** – The T100 tablet contains non-removable batteries. There are no user-serviceable parts in the batteries. Do not disassemble or open, crush, bend or deform, puncture, or shred the batteries. Do not expose to temperatures above +70 °C (+158 °F).

---

---

 **WARNING** – Improper battery use may result in a fire, explosion, or other hazard.

- Do not short circuit a battery or allow metallic or conductive objects to contact the battery terminals.
  - Avoid dropping the device or battery. If dropped, especially on a hard surface, and the user suspects damage to the battery, take it to a service center for inspection.
  - In the event of a battery leak, do not allow the liquid to come in contact with the skin or eyes. If contact has been made, wash the affected area with large amounts of water and seek medical advice.
  - Battery usage by children should be supervised.
- 

## Power supply safety

---

 **WARNING** – Use only AC and vehicle adapters intended for the device. Other external power sources may damage your product and void the warranty.

- Ensure the input voltage on the adapter matches the voltage in your location. Ensure the adapter has prongs compatible with your outlets.
  - The AC power supply is designed for indoor use only. Avoid using the AC power supply in wet areas.
  - Unplug the power supply from power when not in use.
  - Do not short the output connector.
- 

## Touchscreen glass

---

 **CAUTION** – The touchscreen on this device is made of glass. This glass could break if the device is dropped on a hard surface or receives a significant impact. If the glass chips or cracks, do not touch or attempt to remove the broken glass. Cracked or chipped glass due to misuse or abuse is not covered under the product's limited warranty.

---

## Service safety

---

 **WARNING** – Do not attempt to take apart, open, service, or modify the product, accessories, or power supply. Doing so could present the risk of electric shock or other hazard. Any evidence of any attempt to open and/or modify this device, including any peeling, puncturing, or removal of any of the labels, will void the Limited Warranty.

---

## Safe environments of use

---

 **WARNING** – Areas with potentially explosive atmospheres are often, but not always, posted and can include fueling areas, such as below decks on boats, fuel or chemical transfer or storage facilities, or areas where the air contains chemicals or particles, such as grain dust, or metal powders. When you are in such an area, turn off your device, and do not remove or install battery chargers, AC adapters, or any other accessory. In such areas, sparks can occur and cause an explosion or fire.

---

## Distraction

---

 **WARNING** – Using the device in some circumstances can distract you and may cause a dangerous situation. Observe rules that prohibit or restrict the use of devices (for example, avoid operating the device while driving a vehicle).

---

## Telecommunications & Internet Association (TIA)

**Hearing Aids:** Some digital wireless devices may interfere with some hearing aids. In the event of such interference, you may want to consult your service provider, or call the customer service line to discuss alternatives.

**Pacemakers and Other Medical Devices:** The Health Industry Manufacturers Association recommends a minimum separation of six inches be maintained between a handheld wireless device and a pacemaker to avoid potential interference with the pacemaker. These recommendations are consistent with the independent research by and recommendations of Wireless Technology Research. Persons with pacemakers should use the ear opposite the pacemaker to minimize the potential for interference. If you have any reason to suspect that interference is taking place, turn the device OFF immediately.

If you use any other personal medical device, consult the manufacturer of your medical device to determine if they are adequately shielded from external RF energy. Your physician may be able to assist you in obtaining this information.

Turn the device OFF in health care facilities when any regulations posted in these areas instruct you to do so. Hospitals or health care facilities may be using equipment that could be sensitive to external RF energy.

## SAR

This device complies with FCC and CE standards when used as designed.



## Caring for your device

### Cleaning

Turn off the device, and disconnect it from external power. Use a soft, dampened cloth with either water or a diluted mild detergent. If a mild detergent is used, ensure all soap residue is removed. Do not use chemical cleaners.

### Touchscreen care

The rugged T100 tablet is rated IP65, and is designed to withstand extreme conditions and harsh treatment, however taking proper care of the touchscreen will prolong the life and ensure optimal display performance of the touchscreen of this product. Excessive or prolonged exposure to abrasives, oil, dust, chemicals, and ultraviolet light can affect the performance of your touchscreen over time.

To help protect the screen:

- **Clean it frequently.** Use a soft, lint-free cloth to wipe the screen. You can dampen the cloth with water or an eyeglass cleaner.

---

 **WARNING** – Make sure that all ports and doors are fully closed, and that the device is not connected to an external power supply. Do not use chemical or abrasive cleaners.

---

- **Keep it covered when not in use.** Store the T100 tablet in a carry case while you are in transit or not using it.
- **Keep it out of the sun when not in use.** Do not store the T100 tablet in direct sunlight for a long time unnecessarily. Ultraviolet light and excessive heat from sun-loading heat can damage the display.
- **Use proper touchscreen tools.** Use either fingers or the T100 tablet's EMR stylus, or other devices specifically designed for use with capacitive touchscreens to operate the touchscreen of this device. The use of ballpoint pens, metal tools or other sharp objects to operate the touchscreen may scratch and/or damage the surface of the touchscreen.
- **Avoid drops, tumbles, and abrasives.** The T100 tablet is designed to resist damage for drops up to 122 cm (4 feet) onto hard surfaces such as wood and concrete. However, you should protect the display from impact, pressure, and abrasive substances that can scratch it or crack it. The device should not be dropped unnecessarily. Use the screen protectors to keep the touchscreen clean and protected, following the instructions provided on the screen protector packaging.

## Use and storage temperature

The T100 tablet is designed to work in ambient temperatures between -20 °C and 55 °C (-4 °F and 131 °F) and to be stored in temperatures between -40 °C and 70 °C (-40 °F and 158 °F). Avoid exposing the device to dramatic changes in temperature or humidity.

Lithium-ion batteries are sensitive to high temperatures, so keep the device out of direct sun for long periods, and do not leave in a hot car, especially on a dashboard in full sun or other environments where temperatures can exceed +70 °C (+158 °F). Battery life can be shortened if stored, charged, or operated outside of these temperature ranges.

Recommended storage temperature is at room temperature (~+20 °C / +68 °F). When you are using or charging the device, it is normal for it to get warm.

If the interior temperature of the device exceeds normal operating temperatures (for example, in a hot car or in direct sunlight for extended periods of time), you may experience the following as it attempts to regulate its temperature automatically:

- The device stops charging.
- If the device cannot regulate its internal temperature, it may go into a Sleep state until it cools (see [Sleep state, page 28](#)).

Move the device to a cooler location out of direct sunlight and wait a few minutes before trying to use the device again.

## Charging the batteries

Recharge the batteries any time; they do not need to be empty or low before you recharge them. However, it is best to let the battery charge run to below 10 percent at least once a month before you recharge them. Use only the manufacturer designated charging accessories to recharge the device's batteries. Charge only at temperatures between 0 °C and +45 °C (+32 °F and +113 °F) for best battery life and performance.

## Product specifications

Operating System	Microsoft Windows 10 Professional, 64-bit
Processor	Intel® 8th Generation Core™ i5
Graphics	Intel HD Graphics 620
RAM	16 GB
User storage (SSD)	512 GB

---

Display	10.1" LED-backlight screen with capacitive multi-touch 1920 x 1200 pixels EMR stylus support
Battery & Power	Standard capacity 92 Wh Internal, non removable batteries Charge time: 4 hours
I/O module connectors	USB 3.0 Type-C (x2)
Audio	Speaker Microphone
Bluetooth	BT 5.1
Wi-Fi	2.4 GHz / 5 GHz 802.11 ac
4G LTE Mobile broadband (optional)	MicroSIM 4G LTE worldwide coverage, certified on Verizon and AT&T, data only
Camera	8MP, Auto Focus with Flash
Sensors	Accelerometer E-Compass Gyroscope Ambient Light Sensor Proximity Sensor

---

---

Environmental	<ul style="list-style-type: none"> <li>• Operating temperature: -20 °C to +55 °C (-4 °F to +131 °F) <ul style="list-style-type: none"> <li>• MIL-STD-810H 501.7.502.7 Procedure II</li> </ul> </li> <li>• Storage temperature: -40 °C to +70 °C (-40 °F to +158 °F) <ul style="list-style-type: none"> <li>• MIL-STD-810H 501.7.502.7 Procedure I</li> </ul> </li> <li>• Thermal Shock: -20 °C and +60 °C (-4 °F and +140 °F) non-operating <ul style="list-style-type: none"> <li>• MIL STD 810H Method 503.7 Procedure I-C</li> </ul> </li> <li>• Humidity: 0% – 95% non-condensing <ul style="list-style-type: none"> <li>• MIL STD 810H Method 507.6 Procedure II - Aggravated Cycle</li> </ul> </li> <li>• Water and Dust Ingress Protection: IEC 60529 Edition 2 - IP65</li> <li>• Vibration and Shock Resistance: <ul style="list-style-type: none"> <li>• MIL STD 810H Method 514.8 Procedure I</li> <li>• Random Vibration MIL STD 810H Method 514.8 Procedure II - Loose Cargo Transportation</li> </ul> </li> <li>• Drop: Tests include room temperature, -20 °C, +60 °C (-4 °F, +140 °F) <ul style="list-style-type: none"> <li>• MIL STD 810H Method 516.8 Procedure IV - Transit Drop</li> </ul> </li> <li>• Chemical Exposure: Contamination by Fluids <ul style="list-style-type: none"> <li>• MIL STD 810H Method 504.3 Procedure II</li> </ul> </li> <li>• Non Operating Altitude: -30 °C (-22 °F) and 12192 meters (40,000 Feet) <ul style="list-style-type: none"> <li>• MIL STD 810H Method 500.6 Procedure I</li> </ul> </li> <li>• Operating Altitude: +5 °C (+41 °F) and 9144 meters (30,000 Feet) <ul style="list-style-type: none"> <li>• MIL STD 810H Method 500.6 Procedure II</li> </ul> </li> </ul>
---------------	---

---

Mechanical	279 x 200 x 18.5 mm / 11 x 7.9 x 0.73 inches. (W x H x D) 1.65 kg
------------	--

---

# Introduction

- ▶ Registration
- ▶ Configuration options
- ▶ In the box
- ▶ Replacement and spare or optional accessories
- ▶ Parts of the T100 tablet

This user guide describes how to configure and use the Trimble T100 tablet powered by the Windows® 10 Professional operating system. The information in this guide supplements the information in the Quick Start Guide, which you received in the box with the device.

Even if you have used other Trimble handheld or tablet field computers before, it is recommended that you spend some time reading this guide to learn about the special features of the product.

---

 **WARNING** – Before you use this product, make sure that you have read and understood all safety requirements. Failure to follow these safety instructions could result in fire, electric shock, or other injury, or damage to the tablet computer and/or other property. For more information refer to [Safety information, page 14](#) of this guide.

---

## Registration

To receive information regarding updates and new products, contact your local dealer or visit the Trimble customer registration website at [www.trimble.com/register](http://www.trimble.com/register). When you have registered, you can select the newsletter, upgrade, or new product information.

To register your device, you will need the serial number. The serial number is a unique number of your T100 tablet and is located on a label on the back of the device.

## Configuration options

The T100 tablet is powered by the Windows 10 Professional operating system, and is available in the following main configurations:

	T100 (Wi-Fi)	T100 (4G LTE)
WLAN (Wi-Fi)	Yes	Yes
4G Data	No	Yes
Memory Storage (SSD)	512 GB	512 GB

## In the box

A standard pack-out has the following items:

- Trimble T100 tablet with integrated batteries
- EMR stylus with tether
- Replacement EMR stylus tips
- Quick Start Guide
- AC-DC USB-C power adapter
- USB-C to USB-A adapter
- Screen protector

## Replacement and spare or optional accessories

A range of replacement and optional accessories are available to purchase for the T100 tablet, including:

EMR Stylus	P/N 120524
Stylus replacement tips & removal tool	P/N 121359
Handstrap	P/N 121990
Screen Protector (single)	P/N 120516
Office Stand (w.o. AC Adapter)	P/N 121427
Pole mount (medium), with quick release	P/N 120531
Pole mount (long), with quick release	P/N 122906
Carry case	P/N 107727-01
USB-C to USB-A adapter	P/N 123247
Universal mounting plate	P/N 120532

## Parts of the T100 tablet

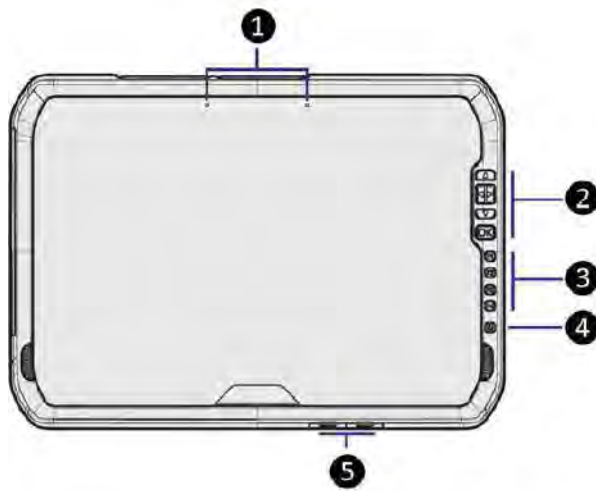

- ① Dual microphones
- ② Directional pad & OK key
- ③ Functional keys x 4
- ④ Power button
- ⑤ USB-C Ports x 2

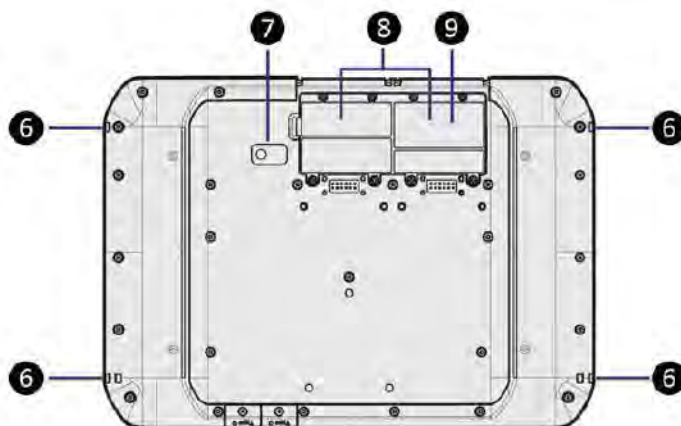

- ⑥ Stylus tether loops x 4
- ⑦ Camera
- ⑧ Trimble EMPOWER module docks x 2
- ⑨ Access to MicroSIM card & MicroSD card slots

# Basic setup and operation

- ▶ [Installing a microSIM card and microSD card](#)
- ▶ [Installing a screen protector](#)
- ▶ [Charging and power modes](#)
- ▶ [Using the touchscreen](#)
- ▶ [Using a USB or Bluetooth mouse and keyboard](#)
- ▶ [Using the EMR stylus](#)
- ▶ [Using the tablet's keys](#)

This section tells you how to get started using the T100 tablet.

When you start the T100 tablet for the first time, the Windows operating system will take you through some basic set-up steps; follow the instructions on the screen.

For more details on setting up and using the Windows 10 operating system see [Using the Windows 10 operating system](#) and [Get Started with Windows 10](#) on the Microsoft Windows support website.

## Installing a microSIM card and microSD card

To use the integrated 4G cellular data modem, you will need a microSIM card and a data plan from your local cellular service provider. If you are unsure, check with your mobile operator.

The device includes 512 GB of onboard storage. To expand the storage, use a microSD card. microSD cards up to 2 TB are supported.

---

 **CAUTION** – The SIM card and SD card bay cover can be damaged if handled carelessly; take care not to twist or warp it when removing or replacing it.

---



1. If the device is on, turn it off; tap-hold , then tap **Shut down or sign out/ Shut down**.
2. If you have EMPOWER modules installed, use a Phillips screwdriver to loosen the screws to remove the EMPOWER module(s).
3. Use a Phillips screwdriver to loosen the screws to remove the cover to the microSIM/ microSD card bay.
4. To insert a microSIM card, place it into the microSIM card slot ensuring its orientation is correct as shown on the device.
5. To insert a microSD card, place it into the microSD card slot ensuring its orientation is correct as shown on the device.
6. Replace the bay cover, and if using modules, re-attach them (see [Using Trimble EMPOWER modules, page 43](#)).

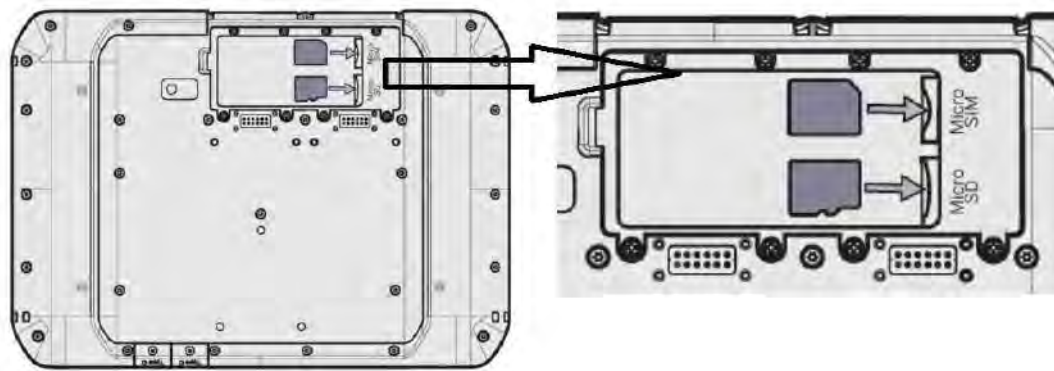

## Installing a screen protector

The T100 tablet is fitted with a chemically strengthened glass touchscreen which is highly resistant to abrasion and impact damage. However to ensure maximum protection, it is recommended that you use a Trimble-approved T100 tablet screen protector.

To install a screen protector:

1. Place the device on a clean, flat surface.
2. Clean the touchscreen with a damp cloth, alcohol wipe or similar.
3. Polish and dry the screen to remove any dust with a lint-free cleaning cloth.
4. Remove the protective film from the screen protector.

5. Align the screen protector with the glass portion of the display. Use the edge of the display as a guide. The screen protector should line up evenly with the edge of the keypad and the edges of the device.

6. Carefully lay the screen protector down on the screen. If you make a mistake and the glass looks off-center, you can gently lift the screen protector up and realign it.

Then, once the protector is on the screen, give it a soft press in the center and allow the adhesive surface to grip to the screen naturally.

7. If there are any bubbles remaining, use the cloth provided to gently smooth them toward the edges of the screen protector.

For more information on where to purchase the correct screen protector for your device, contact your local Trimble reseller.

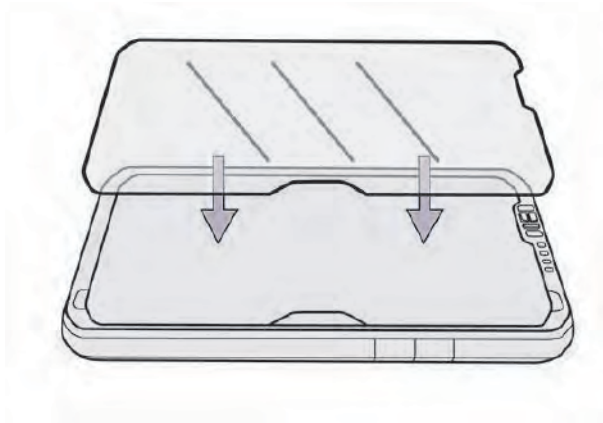

## Charging and power modes

It takes up to 4 hours to charge the T100 tablet batteries from an empty state. It may take longer if you are using your device for standard power-intensive activities, for example using GNSS or processing a lot of data while you are charging it.

### Charging the battery

1. Connect the appropriate international plug adapter for your region to the AC adapter.
2. Connect the power cord to the charging port on the device.
3. Plug the power supply into an electrical outlet.

Two LEDs on the front of the tablet show the charging status:

- Left LED**
- Green solid = device is booting, before the splash screen displays
  - Green flashing = device is in [Sleep state](#)

## Right LED

- Charger connected charging behavior
  - Amber solid = charging
  - Green solid = fully charged
- Discharging behavior, based on the average capacity of both internal batteries
  - Off = battery above 10% State-of-charge, or <10% with system off
  - Red flashing = device is active (short flash) or in [Sleep state](#) (long flash). Battery charge < 10%

To check the current state of the battery charge when the device is off and no charger is connected, press the **F1** key. The right LED will be lit for 4 seconds as follows:

- Green if average capacity is > 80%
- Amber if average capacity is between 20% and 80%
- Red if average capacity is <= 20%

Solid red indicates that a battery has failed internally.

## Turning the device on

To turn on the device, push and quickly release the Power button.



**NOTE** – Do not press the Power button repeatedly; do not hold the Power button for four seconds or longer.

## Power options

The Windows 10 Pro operating system comes with pre-defined power options (Balanced, Power Saver, and High Performance).

To access power options:

1. On the desktop, tap the **Battery icon** in the **Notifications** bar at the bottom right of the screen, then tap **Battery settings**.
2. Make sure **Power & sleep** is selected in the list on the left, then under **Related settings** on the right, tap **Additional power settings**.



By default, the tablet is in Balanced mode.

You can also set the times for the screen to turn off, and the device to go into Sleep state here.

## Sleep state

If you do not use your device for a number of minutes (as set under **Battery settings / Power & sleep**) the screen turns off and the device goes into a power-saving Sleep state. The Sleep state enables your device to resume quickly when you want to start working again.

You can also manually place the device into Sleep state; tap-hold , then tap **Shut down or sign out/ Sleep**.

**TIP** – You can also access the **Sleep** option from the quick-access Power options above the  icon; tap , then tap the quick-access Power icon, then tap **Sleep**.



To wake the device from Sleep state, press the Power button. After waking your device, to unlock it:

1. Swipe up from the bottom edge of the screen.
2. At the sign-in screen, tap **Sign in** and if required enter your password or PIN.

**NOTE** – Sleep state is different from the screen 'turning off' to save power, from which you can 'wake' the screen by tapping / swiping it.

## Restarting the device

To restart your device, tap-hold , then tap **Shut down or sign out/ Restart**.

**TIP** – You can also access the **Restart** option from the quick-access Power options above the  icon; tap , then tap the quick-access Power icon, then tap **Restart**.

## Turning off the device

To turn off the device, tap-hold , then tap **Shut down or sign out/ Shut down**.

For information on customizing power management features, see [Power options, page 28](#).

**TIP** – You can also access the **Shut down** option from the quick-access Power options above the  icon; tap , then tap the quick-access Power icon, then tap **Shut down**.

## Checking the battery charge

You can check the battery charge:

- on the Lock screen. When you wake the device, the battery status appears in the lower-right corner of the Lock screen.
- on the Desktop taskbar. The battery status appears on the right side of the taskbar. Tap the battery icon for information about the charging and battery status, including the charge percent remaining.

## Making your battery last longer





Following are some practical suggestions that you can do to maximize the operating time of the battery:

- Enable Power Management, and choose a power plan that saves power. A power plan is a collection of hardware and system settings that control how the device manages power.
- Decrease the display brightness to the lowest comfortable level.
- Shorten the length of time before the operating system turns off the display.
- If you use a USB flash drive, unplug it when you are not using it. Many USB devices use power just by being connected.
- Turn off the wireless radios when you are not using them. See [Connecting to and using wireless networks, page 38](#).
- Turn off the tablet computer when you are not using it. See [Turning off the device, page 28](#).

For more information on making your battery charge last longer, refer to the help topic on *Battery Saving tips on the Windows 10* support site on [www.microsoft.com](http://www.microsoft.com).

## Using the touchscreen

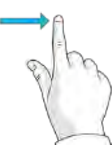
The T100 tablet can be easily operated with the touchscreen (using your fingers or the EMR stylus), a mouse, and the keypad. You can easily switch between any of these input methods. The main input gestures and functions supported on this device are:

<p>Tap</p> 	<p>Tap once on something.</p>	<p>Opens/executes the action of what you tap on. To enter text, tap where you want to type; the onscreen keypad displays.</p>
<p>Press-hold</p> 	<p>Press-hold your finger or the EMR stylus down for a few seconds.</p>	<p>Shows a menu with options related to what you're doing (like right-clicking with a mouse). On the pop-up menu that appears, tap the action you want to perform.</p>
<p>Double-tap</p> 	<p>Double-tap on something.</p>	<p>Tap quickly twice on a webpage, map, or other screen to zoom. Double-tapping after pinching to zoom in some apps, such as Browser, reflows a column of text to fit the width of the screen.</p>
<p>Slide / swipe</p> 	<p>Slide / swipe your finger or the EMR stylus across the screen.</p>	<p>Scrolls through what's on the screen. Quickly move your finger across the surface of the screen, without pausing when you first touch it, to scroll a page or a list up or down. Scrolls vertically or horizontally.</p>
<p>Drag</p> 	<p>Drag your finger or the EMR stylus across the screen.</p>	<p>Hold your finger or the EMR stylus on an item for a moment and then, without lifting your finger/the EMR stylus, move across the screen until you reach the target position.</p> <ul style="list-style-type: none"> <li>• Drag in a list to select multiple items.</li> <li>• Drag items on the screen to reposition them.</li> </ul>
<p>Pinch / stretch</p> 	<p>Pinch your thumb and forefinger together or move them apart.</p>	<p>Zooms in or out of a website, map, or picture.</p>

---

 Rotate

Put two or more fingers on an item and then turn your hand.

---

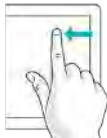
 Swipe from edge

Swipe in from an edge of the screen.

- Left edge swipe. Displays the Task View, the universal task-switching interface. See [Using Task View and virtual desktops, page 35](#).
  - Right edge swipe. Displays the Action Center. See [Using the Action Center, page 34](#).
  - Bottom edge swipe. Displays the taskbar when the currently-running app is displayed full screen.
- 

## Using the onscreen keypad

You can type on the device using the touchscreen keypad. To access the onscreen keypad, tap in a text field. To hide the keypad, tap X in the top right corner of the keypad.

## Using a USB or Bluetooth mouse and keyboard

You can attach a physical keyboard, mouse and other peripherals to your device via USB or Bluetooth wireless technology. For more information see [Connecting to accessories and other devices, page 41](#).

## Using the EMR stylus

Take notes, draw, navigate, and mark up documents directly on the screen using the EMR stylus. The EMR stylus works by wireless transfer, conversion, and detection of electromagnetic waves for use on touchscreens.

The EMR stylus is designed to work with the tablet automatically; no Bluetooth or Wi-Fi connection is required. The stylus works once it is close to the touchscreen.

**NOTE** – When using the EMR stylus, the screen will not respond to finger touch.

## Tethering and storing the stylus

Tether the EMR stylus to any of the four corners of the back of the tablet. Store the stylus in the stylus holder.

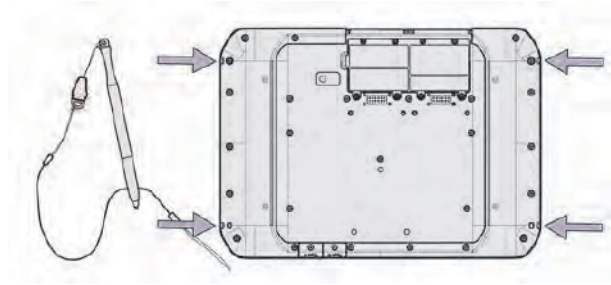

## Caring for the stylus

**⚠ CAUTION** – Read the instructions carefully. Failure to follow the instructions could result in damage to the EMR stylus and voiding its warranty.

- Use the EMR stylus only in accordance with the operation guide.
- Do not attempt to open or disassemble the EMR stylus as this will void the warranty.
- Do not expose the EMR stylus to extreme temperatures or direct sunlight.
- If there is any damage or broken parts, do not use the EMR stylus. Contact your reseller or service provider.
- Clean with a dry cloth. Do not use water, soap, detergent, or other chemicals.

## Using the tablet's keys

There are a number of keys on the front right of the tablet:



- ➊ Directional pad and OK key
- ➋ Function keys x 4
- ➌ Power button





# Using the Windows 10 operating system

- ▶ Using accounts
- ▶ Using the Start menu
- ▶ Using the Action Center
- ▶ Using the Windows Mobility Center
- ▶ Using Task View and virtual desktops
- ▶ Settings
- ▶ Display settings: adjusting the backlight
- ▶ Display settings: rotation lock

This section introduces some basic information on using the Windows 10 Pro operating system on your T100 tablet. For comprehensive information, go to [Get Started with Windows 10](http://windows.microsoft.com) on <http://windows.microsoft.com>.

## Using accounts

When you set up your T100 tablet, an account is set up for you. You can create additional accounts later for each user of the device, so that each person using the device can have their own settings.

To set up additional accounts and to change account settings, tap , then tap the quick-access Accounts icon above the  icon. Or, go to  / Settings / Accounts.

## Signing in

1. Press the Power button to turn on or wake the T100 tablet.
2. Swipe up on the screen.

3. If there are multiple accounts set up on the tablet, select your account from the list. Tap **Sign in** and enter your password (if one has been set).

## Signing out

Tap-hold , and tap **Shutdown or sign out**, then tap **Sign out**.

## Using the Start menu

Tap  open the **Start** menu.

At the lower left of the **Start** menu, you'll find quick links to **Account** settings, all other **Settings**, and **Power** (shut down, sleep, and restart).

The apps you've used most often appear at the top of the **Start** menu.

Tiles on **Start** act as quick links to apps. You can rearrange, resize, add, and remove tiles whenever you want. To add an app tile, tap-hold it in the **Start** menu and drag-drop it to the **Tiles** area. For more information, see [Organize your apps](http://windows.microsoft.com) on <http://windows.microsoft.com>.

## Using the Action Center

Swipe in from the right edge of the screen or tap **Action Center**  on the taskbar to open the Action Center.

Examples of what you can use the Action Center for include:

- viewing notifications
- adjusting common settings like Wi-Fi connections or screen brightness
- creating a wireless connection to other devices

For more info, see [Find your notifications](http://windows.microsoft.com) on <http://windows.microsoft.com>.



## Using the Windows Mobility Center

Tap-hold , and tap **Mobility Center**. Use the Mobility Center to, for example:

- view device information
- adjust common settings such as screen brightness, screen rotation, and volume

## Using Task View and virtual desktops

Task View allows you to quickly hide all windows and show the desktop, find an open window, and manage windows across multiple "virtual desktops".

Swipe in from the left edge of the screen or tap **Task View** on the taskbar to display all open windows, access any virtual desktops you have set so you can switch between them, and add more virtual desktops if you need to.



## Settings

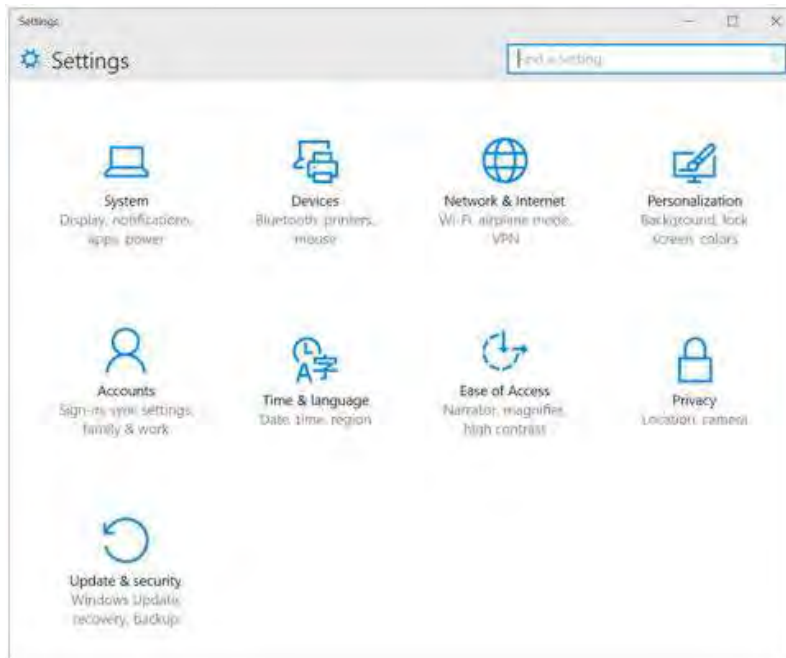

Tap  / Settings to access all your settings.



## Display settings: adjusting the backlight

The T100 tablet is equipped with a high brightness outdoor readable display. You can easily increase the brightness of the display to increase its readability in bright sunlight conditions, or turn down the brightness to help conserve battery power when working indoors or in dull conditions. You can also have the device automatically adjust the display brightness depending on the ambient light conditions.

To quickly adjust the display brightness setting:

1. Swipe in from the right edge of the screen or tap **Action Center**  on the taskbar to open the Action Center.
2. Tap the brightness icon  to adjust the display brightness setting. The backlight cycles between 0%, 25%, 50%, 75%, and 100% power. Tap until you reach the backlight level that best suits your conditions.

To manually adjust the display brightness setting:

1. Tap  / Settings / System / Display.
2. Use the brightness level slider to fine tune the display brightness level.

## Display settings: rotation lock

The T100 tablet is equipped with orientation sensors that can detect if your device is in portrait or landscape orientation. The operating system can automatically adjust the display to match your device orientation, or you can lock the orientation.

To adjust the automatic display orientation feature, swipe in from the right edge of the screen or tap **Action Center**  on the taskbar to open the Action Center, then select

rotation lock  to turn rotation lock on or off.

# Connecting to and using wireless networks

- ▶ [Airplane mode](#)
- ▶ [Working with Wi-Fi networks](#)
- ▶ [Working with cellular broadband](#)

The T100 tablet supports wireless connectivity, allowing you to connect to wireless networks using the built-in Wi-Fi radio (also sometimes called Wireless LAN, WLAN, or 802.11).

The T100 tablet 4G model comes with built-in cellular broadband data (also called Wireless WAN, WWAN, or cellular data) capability.

This section describes how to get online with your T100 tablet using these wireless networking capabilities.

## Airplane mode

If you are traveling on an airplane, or don't need to use wireless functions on the T100 tablet for a while, use Airplane mode to turn off all wireless radios with transmitting features built into the T100 tablet, including Bluetooth, Wi-Fi, Cellular, and GNSS, as well as any wireless radios connected to the T100 tablet.



To turn on Airplane mode, tap the Wireless network icon  in the bottom-right corner of the screen, then tap Airplane mode.

## Working with Wi-Fi networks

Using Wi-Fi you can connect to a wireless network and browse the Internet, download apps, send email messages, access online services, or access other computers and devices on your network.

Before you can send and receive data over Wi-Fi, you need to turn on Wi-Fi on your T100 tablet and connect to a wireless network.

### Connecting to Wi-Fi

1. Tap the Wireless network icon  in the bottom-right corner of the screen.  
A list of available wireless networks appears.
2. Select the Wi-Fi network you want to connect to.
3. Tap **Connect**. If prompted, enter your network security key (network password), and tap **Next**.
4. If prompted, choose whether you want to share with other computers and devices on the network. Select **No** if you are connecting to a network in a public place like a café.
5. To check your connection, tap , and select **Microsoft Edge**. Some wireless networks may require you to enter a password in a browser window.

### Disconnecting from a Wi-Fi network

1. Tap the Wireless network icon  in the bottom-right corner of the screen.
2. Select the network that has a **Connected** status and tap **Disconnect**.

### Forgetting a Wi-Fi network

If you do not want your device to automatically connect to a saved Wi-Fi network, you can forget that network.



To forget a wireless network so it no longer appears in your list of networks:

1. Tap  / **Settings**.
2. Select **Network and Internet / Wi-Fi / Manage known networks**.
3. Tap the network you want to forget, then tap **Forget**.

## Working with cellular broadband

Before you can connect to a cellular broadband network, you must insert a SIM card (see [Installing a microSIM card and microSD card, page 24](#)), turn on Cellular data, and configure the connection.

### Connecting to cellular broadband

1. Tap the Wireless network icon  in the bottom-right corner of the screen, tap **Cellular** to turn it on, then tap-hold it and tap **Go to Settings**. (Or, tap  / **Settings** / **Network and Internet** / **Cellular**.)
2. Under **Cellular**, select the name of your operator—for example, AT&T.
3. If you want to connect to this network every time it's in range, select **Connect automatically**.
4. Windows will switch automatically between Wi-Fi and cellular broadband as needed. You might incur extra charges if you allow roaming.
5. Tap **Connect**.

For more information, refer to the help topic on *Cellular settings in Windows 10* on the Windows 10 support site [www.support.microsoft.com](http://www.support.microsoft.com).

### Locating the device's IMEI number

The IMEI number is a unique 15-digit number that identifies the cellular module installed on your device. Your cellular broadband operator may need to know the IMEI number of your device in order to register the device with the network and activate your cellular broadband data plan.

If your T100 tablet is cellular broadband enabled, the IMEI number will be printed on the serial number label on the back of the device.

Alternatively, to check the IMEI number in the operating system:

1. Tap **Settings** / **Network and Internet** / **Cellular**.
2. Select the Cellular module icon, then select **Advanced options**.  
The cellular module properties (including the IMEI) are displayed in the **Properties** section.
3. To copy the IMEI number to the clipboard, select **Copy**, then paste the text into your desired application (for example, Notepad, or the Email client) using the **Paste** command or the Ctrl+V keypad shortcut.

If you cannot find the IMEI number for your device, contact your reseller.



# Connecting to accessories and other devices

- ▶ Using the office stand
- ▶ Mounting the tablet on a pole
- ▶ Connecting to USB accessories
- ▶ Connecting to Bluetooth accessories
- ▶ Using Trimble EMPOWER modules

You can connect monitors, accessories, and other devices directly to your T100 tablet using USB or Bluetooth.

## Using the office stand

An optional office stand is available for the T100 tablet for convenient docking to your office peripherals such as a monitor, keyboard and mouse. The office stand does not include any electronics and is designed to hold up your T100 tablet so that you can easily attach USB-C accessories.

When using the office stand, make sure the T100 tablet is securely placed in the stand, and connect your computer peripherals to the USB ports on the T100 tablet.

## Mounting the tablet on a pole

1. Attach the pole mount base plate to the back of the T100 tablet.
2. Attach the pole clamp to the pole.
3. Attach the base plate on the back of the T100 tablet to the clamp on the pole.

## Connecting to USB accessories

The T100 tablet has two USB Type C ports for connecting USB devices such as a flash drive, scanner, printer, keyboard, or mouse.

Other types of USB devices may require drivers.

To connect a USB device, flip open a port cover on the bottom of the T100 tablet and plug the device cable into the USB Type C port.

## Connecting to Bluetooth accessories

The T100 tablet has embedded Bluetooth wireless technology—a short-range wireless communication technology that allows wireless data transfer and communication between devices over a distance of up to 10 meters (30 feet).

Use the Windows System Tray or [Action Center](#) to configure Bluetooth wireless connections. Follow the instructions and options in the Bluetooth application.

**TIP** – To save battery, turn off Bluetooth when you are not using it. Bluetooth is off when the device is in Airplane mode.

Before you can transfer data or communicate between your T100 tablet and another Bluetooth enabled device, you must pair the T100 tablet and the device.

To pair and connect the T100 tablet with a Bluetooth device:

1. Turn on the Bluetooth device and make it discoverable. To learn how to do this, check the documentation for your Bluetooth device or go to the manufacturer's website.
2. Tap  / **Settings** / **Devices** / **Bluetooth**, or use the Action Center to access Bluetooth settings.
3. Make sure the slider is set to On, and wait while the T100 tablet searches for Bluetooth devices.
4. In the list of Bluetooth devices, select the device you want to pair with your T100 tablet, then tap **Pair**.
5. Follow the on-screen instructions to finish pairing your device.
6. If the other device requires a passcode (sometimes called a pairing code), you'll be prompted for it. If you don't know the passcode, check the information that came with your device or the manufacturer's website.

## Using Trimble EMPOWER modules

Trimble EMPOWER modules can be used to extend or expand the basic capabilities of your device. Each EMPOWER module can be installed, removed, or moved from one EMPOWER-enabled device to another.

The T100 tablet allows up to two EMPOWER modules to be installed at a time.

For more information about using EMPOWER modules, refer to the module documentation available here: [www.trimble.com/empowermodules](http://www.trimble.com/empowermodules).

### Installing EMPOWER modules

1. Make sure your device is turned off. For more information, see [Charging and power modes, page 26](#).
2. Turn the device over and hook the EMPOWER module onto the device, ensuring that the slots on the top of the device line up with those on the EMPOWER module.
3. Tighten the captive screws at the bottom of the EMPOWER module using a Phillips #1 screwdriver. Do not overtighten the screws.
4. Turn on the device and start the EMPOWER Hub (found under Start / EMPOWER / EMPOWER Hub). The EMPOWER Hub is a centralized location for managing and monitoring your EMPOWER modules.

**NOTE** – Some modules may require that additional drivers and/or supporting applications be installed before the base device recognizes the module. These files can be downloaded from: [www.trimble.com/empowermodules](http://www.trimble.com/empowermodules).

**NOTE** – Before you remove a module from the device, make sure the device is powered off.

# Using the camera

- ▶ Taking photos and videos
- ▶ Changing camera settings
- ▶ Enable the Camera app to access your location to geo-tag photos
- ▶ Viewing photos and videos

The T100 tablet is fitted with an 8 MP camera.

## Taking photos and videos



By default, the Camera app is ready to take photos, but you can switch easily between photo mode, video mode, or panorama mode.

To take a photo or panorama or record a video:

1. Tap  / **Camera**.
2. Tap the on-screen **Camera** button to take a picture, or tap the **Panorama** or **Video** icon on the right to switch modes. To record a panorama or video, tap the icon again.

Your latest photo, panorama, or video shows as a thumbnail in the lower right corner of the window. You can tap this to access the Pictures library. See [Viewing photos and videos, page 45](#) for more information.

## Changing camera settings



Tap  / **Camera** to launch the Camera app. Some settings are available on the left side of the screen. Tap  in the top left corner of the window to access further settings, such as:

- the photo quality / aspect ratio.
- the framing grid.
- video recording settings, like frames per second or flicker reduction.

- location info. See [Enable the Camera app to access your location to geo-tag photos, page 45](#) for more information.

To hide the camera settings, tap anywhere in the window away from the **Settings** panel.

## Enable the Camera app to access your location to geo-tag photos

1. Tap  / **Camera** to launch the Camera app.
2. Tap  in the top left corner of the screen.
3. Under **Related settings**, tap **Choose whether camera can use location info**.
4. Tap **Yes** to confirm you want to switch apps.
5. In the **Settings** screen, make sure **Location** is selected in the list on the left.
6. Under **Location**, if the device shows **Location for this device is off**, tap **Change**, and tap the **Location for this device** switch to turn it **On**.
7. Scroll down to **Choose apps that can use your precise location**, and tap the **Camera** switch to turn it **On**.
8. Close the **Settings** app to return to the **Camera** app.

## Viewing photos and videos

By default, your photos, panoramas, and videos are saved to **Pictures / Camera Roll** on the T100 tablet.

There are several ways to look through and work with your photos and videos:

- In the **Camera app**, tap the thumbnail of the last photo, panorama, or video you captured; this thumbnail appears in the bottom right corner of the window. The photo / panorama / video opens in a new window. Use the arrows to scroll through the collection.

From within this window, you can also quickly go to your **Pictures** library—tap **View All photos** in the top left corner of the window.

- Open **File Explorer**, and go to your **Pictures** library and open the **Camera roll** or the folder you have saved photos / panoramas / videos in.
- Use the **OneDrive** app.

# Using the pre-installed apps

- ▶ [Bundled Microsoft apps](#)
- ▶ [Getting more apps](#)

The T100 tablet comes with a range of useful pre-installed software. This chapter describes the most important pre-installed apps you should know about, and summarizes what they can be used for.

## Bundled Microsoft apps

Some of the useful applications that come bundled with your T100 tablet are:

- OneNote: You can use the OneNote app to take notes and store them in the cloud. For more info, see [www.onenote.com](http://www.onenote.com).
- Mail: Mail automatically organizes your inbox. You can add multiple accounts and access them through this single point.
- Calendar: Use Calendar to manage your schedule.
- People: The People app brings all your contacts together in a single space. See each contact's email address, phone number, website, and other information at a glance.
- Microsoft Edge: Microsoft Edge gives you fast and fluid access to the Internet. Open pages in Reading View, save them to your reading list, or take notes right on the page using inking. See [Get to know Microsoft Edge](#) on [www.microsoft.com](http://www.microsoft.com) for details.
- Camera: The Camera app lets you take regular photos, panoramas, or video. See [Using the camera, page 44](#) for more information.
- Weather: The Weather app offers hourly, daily, and 10-day forecasts as well as historical information and annual weather trends.

## Getting more apps

You can install more apps and programs from the Windows Store, websites, or a CD or DVD. To learn more see [How to install programs on Windows 10](#) on <https://support.microsoft.com>. To find applications for your T100 tablet, go to Microsoft Store on [www.microsoftstore.com](http://www.microsoftstore.com).

# Troubleshooting, downloading updates, and repair

- ▶ [Troubleshooting](#)
- ▶ [Operating system and software updates](#)
- ▶ [Repairing your device](#)

## Troubleshooting

This section contains answers to some common troubleshooting questions. If you encounter problems when using your T100 tablet, try the following troubleshooting tips to detect and solve the problem. If problems persist, contact your local reseller for support.

## Further assistance and support with the Windows 10 Pro operating system

For comprehensive online support, how-to guides, troubleshooting articles and related downloads for the Windows 10 Pro operating system, go to the online Microsoft support pages for the Windows 10 operating system.

## Performance issues

### Device is running slowly

- Operating system updates may be installing.

Windows 10 Pro may have automatically downloaded software or operating system updates, and is installing these in the background. While these updates are being installed, system performance may be reduced, or wireless connectivity speed may appear to be slower than normal.



- You may have too many background applications running.  
Some programs start automatically and run in the background. You can disable these programs at startup to improve Windows startup time and overall system performance.
- You may have malware or a virus.  
A virus or other malicious software could cause your device to run slowly. Check whether your device has a virus by using Windows Defender, which is included with Windows 10, or refer to the documentation for your third party antivirus software.
- Check your wireless network speed.  
If the apps you are using are connecting to the Internet, a poor network connection may be causing them to run slowly. For detailed information on checking your network, see [Wi-Fi speed is slow, page 49](#).
- Check for low disk space.  
You may be able to improve performance if you free up some disk space on your device. Disk Cleanup can delete temporary and system files, empty the Recycle bin, and remove apps and data that you no longer need.
- Your device may have overheated.  
If you are using your device in a hot environment and/or are using a processor- or memory-intensive app, your device may have become too hot. Move your device to a cooler spot, wait five minutes, and see if it runs faster.

## Wireless connectivity issues

### Wi-Fi speed is slow

- Your network is running slow for all devices.  
You should first check to see whether your network is slow on another device. Can you connect to your wireless network and browse the web at normal speeds from another PC, tablet, or smartphone? Try running a Network Speed Test to ensure your Internet connection is functioning normally.
- Your Wi-Fi signal is weak.

Check the Wireless network icon in the taskbar. This icon  shows your current signal strength. If the icon is partially dimmed, move your device closer to your wireless router to see if the signal improves. If your router is broadcasting on both a 2.4 GHz and 5 GHz frequency, try connecting to a different frequency. In general, a network operating on the 5 GHz frequency will be faster and less susceptible to interference, but will have a shorter range than a 2.4 GHz network.

## Wi-Fi is not connected

- There is no Wi-Fi connectivity.

Make sure that the tablet is not in Airplane mode; Airplane mode must be OFF in the operating system. See [Airplane mode, page 38](#).

## Power and battery issues

### Battery will not charge

- The battery is overheated, or too cold.

The battery will charge between 0 °C and +45 °C (+32 °F and +113 °F). If you have been using or storing the device in a particularly hot or cold environment, the battery may be outside the safe charging temperature range. Sensors in the battery will prevent the battery from charging until its temperature returns to a normal level.

### Device will not start up

- The battery does not have enough charge to power the device.

Check the battery charge; see [Checking the battery charge, page 29](#). If the battery charge is low, attach the device to an external power source, then try again.

### Device suddenly turns off during use

- Make sure you are not accidentally pressing the Power button.

The Power button is located on the lower front right of the device. Make sure that while gripping the device that you are not accidentally pressing the Power button and suspending the unit.

- The device may have run out of power and gone into critical suspend mode.

If your battery charge level gets too low, the device will automatically go into a hibernate mode to prevent loss of data. If the battery charge is too low, connect the device to external power.

## Restarting or resetting the operating system

If your device becomes unresponsive and you cannot resolve the problem, you need to restart or reset your device.

For detailed instructions on the recovery options in Windows 10, refer to the Microsoft support pages on Windows 10 recovery options at [www.support.microsoft.com](http://www.support.microsoft.com).

## Restarting your (unresponsive) device

If your device is no longer responding to touchscreen or keypad input, you may need to force it to restart by removing power from the system.

**NOTE** – Restarting the system by holding down the Power button removes power to the CPU. Any unsaved files and settings will be lost.

To force your device to restart, press and hold the Power button until the device shuts down (~10 seconds), then restart your device by pressing the Power button.

## Resetting your device

If restarting your device does not resolve the issue that you are seeing, resetting it might help. Resetting lets you choose to keep your files or remove them, and then reinstalls the operating system.

To reset your device:

1. Tap  / Settings / Update & Security / Recovery.
2. Under **Reset this PC**, tap **Get started** then follow the onscreen instructions to reset your device.
3. At the reset menu, select one of the following:
  - **Keep my files.**
    - Reinstalls Windows 10 and keeps your personal files.
    - Removes apps and drivers you installed.
    - Removes changes you made to settings.
    - Removes any apps your dealer or distributor installed.
  - **Remove everything.**
    - Reinstalls Windows 10 and removes all your personal files.
    - Removes apps and drivers you installed.
    - Removes changes you made to settings.
    - If you're planning to donate, recycle, or sell your device, use this option and choose to fully clean the drive. This might take an hour or two, but it makes it harder for other people to recover files you have removed.

## Resetting your device when the operating system is unresponsive

If you want to restore your device but cannot operate the touchscreen or the operating system is not responding to normal input, you may need to reset the device from the Boot

Menu.

To reset from the Boot Menu:

1. Connect an external USB keypad to the device.
2. Press the Windows logo key  to get to the sign-in screen, then hold down the **Shift** key and select **Power / Restart** in the lower-right corner of the screen.
3. When the device restarts, tap **Troubleshoot / Reset this PC**.

If you cannot get to the sign-in screen, use a recovery drive or installation media to reset your device.

## Operating system and software updates

Periodically, operating system and software application updates will be available for your device.

### Windows 10 updates

The Windows 10 operating system periodically checks for updates so you don't have to. When an update is available, it is automatically downloaded and installed — keeping your device up-to-date with the latest features.

Installing the latest updates can help fix common issues, but you must be online to download the updates. Once online, to check for and install the latest updates manually, go to **Settings / Update & security / Windows Update**, and select **Check for updates**. If **Windows Update** says your device is up to date, you have all the updates that are currently available.

For more information about Windows updates, refer to the official *Windows Update FAQ* on [www.microsoft.com](http://www.microsoft.com).

### Software downloads and updates

The latest versions of software including drivers, firmware updates, and software utilities, are available on the [technical support pages](http://www.trimble.com) on [www.trimble.com](http://www.trimble.com).

## Repairing your device

Before you send your T100 tablet for repair, check the Troubleshooting section in this user guide. If you can't solve the problem with troubleshooting, contact your local Trimble dealer for further support.

Repair of this product should only be performed by an authorized service provider. Any attempt to disassemble this product by a non-authorized service provider will void the warranty.

For more information, contact your local Trimble dealer.

