

# P4 MULTISPECTRAL

User Manual v1.4

2020.08



### **Searching for Keywords**

Search for keywords such as “battery” and “install” to find a topic. If you are using Adobe Acrobat Reader to read this document, press Ctrl+F on Windows or Command+F on Mac to begin a search.

### **Navigating to a Topic**

View a complete list of topics in the table of contents. Click on a topic to navigate to that section.

### **Printing this Document**

This document supports high resolution printing.

# Using This Manual

## Legend

⚠ Warning

⚠ Important

💡 Hints and Tips

📖 Reference

## Before Flight

The following documents have been produced to help you safely operate and make full use of your aircraft:

1. In the Box
2. User Manual
3. Quick Start Guide
4. Disclaimer and Safety Guidelines

It is recommended to watch all tutorial videos on the official DJI™ website and read the disclaimer and safety guidelines before first time use. Prepare for your first flight by reviewing the quick start guide. Refer to this user manual for more details.

## Video Tutorials

Go to the address below or scan the QR code on the right to watch the tutorial videos, which demonstrate how to use the P4 Multispectral safely:

<https://www.dji.com/p4-multispectral/video>



## Download DJI GS Pro App

The latest version of DJI GS Pro is required when using with the P4 Multispectral. Search for DJI GS Pro in App Store or scan the QR code to download the app on your iPad. Visit the official DJI website for more information about DJI GS Pro.

<https://www.dji.com/ground-station-pro>



## Download DJI Terra

The multispectral images captured by the P4 Multispectral can be imported into DJI Terra for 2D multispectral map reconstructions. To download the latest version of DJI Terra and its user manual, please visit: <https://www.dji.com/dji-terra/info#downloads>



The operating temperature of this product is 0° to 40° C. It does not meet the standard operating temperature for military grade application (-55° to 125° C), which is required to endure greater environmental variability. Operate the product appropriately and only for applications that it meets the operating temperature range requirements of that grade.

---

# Contents

<b>Using This Manual</b>	2
Legend	2
Before Flight	2
Video Tutorials	2
Download DJI GS Pro App	2
Download DJI Terra	2
<b>Product Profile</b>	6
Introduction	6
Feature Highlights	6
Preparing the Aircraft	7
Activating the Aircraft	8
Aircraft Overview	9
Remote Controller Overview	10
<b>Aircraft</b>	12
Profile	12
Flight Modes	12
Aircraft Status Indicators	13
Return to Home (RTH)	14
Aerial Photography Missions	18
RTK Functions	20
Vision System and Infrared Sensing System	20
Flight Recorder	23
Attaching and Detaching the Propellers	23
DJI Intelligent Flight Battery	24
<b>Gimbal Cameras</b>	31
Cameras	31
Gimbal	32
<b>Remote Controller</b>	34
Profile	34
Using the Remote Controller	34
Remote Controller Status LED	39
Linking the Remote Controller	39

<b>Flight</b>	41
Flight Environment Requirements	41
GEO (Geospatial Environment Online) System	41
Flight Restrictions	42
GEO Unlocking	43
Preflight Checklist	44
Calibrating the Compass	44
Starting/Stopping the Motors	45
Stopping Motors Mid-flight	46
Flight Test	46
<b>DJI Assistant 2 for Phantom</b>	49
Installation and Launching	49
Using DJI Assistant 2 for Phantom	49
<b>Appendix</b>	51
Specifications	51

# Product Profile

---

This section introduces the P4 Multispectral and lists the components of the aircraft and remote controller.

# Product Profile

## Introduction

The P4 Multispectral is a high-precision drone capable of multispectral imaging functions. The imaging system contains six cameras with 1/2.9-inch CMOS sensors, capable of capturing both color and narrow band images. The OCUSYNC™ HD image transmission built into both the aircraft and remote controller ensures stable transmission. Using DJI GS Pro, users can view the NDVI, GNDVI, or NDRE image in real time and gain insights into plant health, understanding plant growth, soil conditions, and more. The images can also be used to generate accurate multispectral index maps for detailed plant and soil status analyses, which enable more precise agricultural operations. The aircraft has a built-in DJI Onboard D-RTK™, which provides precision data for centimeter-level positioning accuracy\*.

## Feature Highlights

The P4 Multispectral imaging system contains six cameras with 1/2.9-inch CMOS sensors, including an RGB camera and a multispectral camera array containing five cameras for multispectral imaging, covering the following bands: Blue (B): 450 nm ± 16 nm; Green (G): 560 nm ± 16 nm; Red (R): 650 nm ± 16 nm; Red edge (RE): 730 nm ± 16 nm; Near-infrared (NIR): 840 nm ± 26 nm. The spectral sunlight sensor on top of the aircraft detects the solar irradiance in real-time for image compensation, maximizing the accuracy of collected multispectral data. The P4 Multispectral uses a global shutter to avoid distortions that might be present when using a rolling shutter.

The P4 Multispectral aircraft has a built-in DJI Onboard D-RTK, providing high-precision data for centimeter-level positioning when used with Network RTK service or a DJI D-RTK 2. Raw satellite observations and exposure event records can be used for post-processed kinematic (PPK) differential corrections (supported later).

The P4 Multispectral can hover and fly in extremely low altitude and indoor environments, and provides multi-directional obstacle sensing and vision positioning functions. Obstacles detection and avoidance in large range and landing protection enhance flight safety.

Built into the remote controller is the latest DJI OcuSync technology with enhanced anti-interference capability to deliver a more stable and smoother image transmission. When combined with the receiver in the aircraft, the remote controller has a transmission range up to 4.3 mi / 7 km (FCC-compliant version). Connect an iPad to the remote controller via the USB port to use DJI GS Pro app to plan and perform missions.

Import the image data into DJI GS Pro or DJI Terra to generate multispectral index maps and view the analysis.

\* This should be used with Network RTK service, a DJI D-RTK 2 High-Precision GNSS Mobile Station (purchased additionally) or post-processed kinematic (PPK) data (recommended when RTK signal is weak during operation).

## Preparing the Aircraft

1. Remove the gimbal clamp from the camera as shown in the figure.

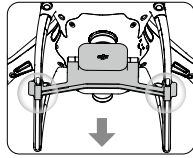

2. Attaching the Propellers

Mount the propellers with black propeller rings to the motors with black dots. Mount the propellers with silver propeller rings to the motors without black dots. Press the propeller down onto the mounting plate and rotate in the lock direction until it is secured.

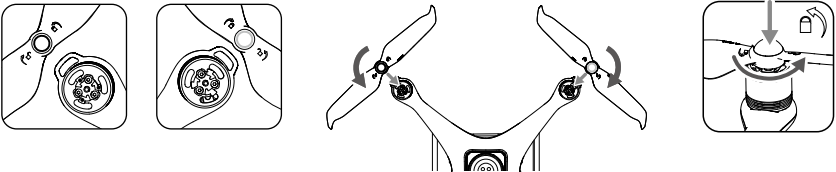

3. Battery Installation

Slide battery into the battery compartment according to the arrow's direction as shown below.

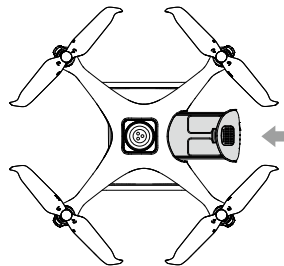

When the upper and lower buckles on the battery are in place, a click sound indicates the battery is securely installed. Failure to do so may affect the flight safety of your aircraft.



## Preparing the Remote Controller

1. Tilt the mobile device holder or the display device on the remote controller to the desired position, then adjust the antennas so they are facing outward.
2. Connecting your mobile device
  - ① Press the button on the top right side of the mobile device holder to release the clamp, then adjust the clamp to fit the size of your mobile device.
  - ② Secure your mobile device in the clamp by pressing down.
  - ③ Plug one end of the cable into the mobile device, and the other end into the USB port on the back of the remote controller.

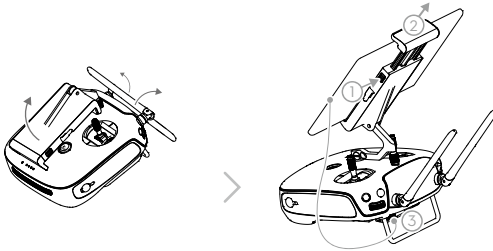

## Activating the Aircraft

When using your P4 Multispectral for the first time, activate it using DJI GS Pro. Ensure that your iPad has access to the internet.

## Aircraft Overview

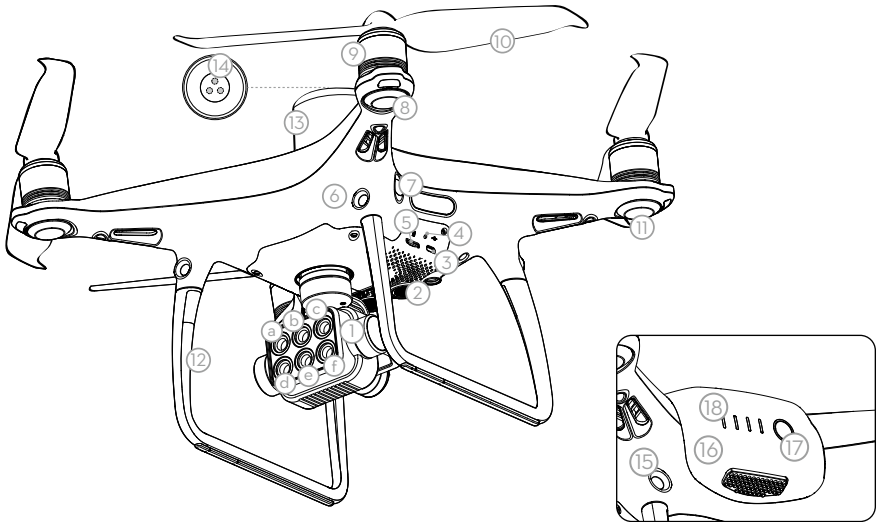

1. Gimbal Cameras  
(with six cameras corresponding to the wave bands below)
  - a. Red Edge (RE)
  - b. Near-Infrared (NIR)
  - c. Green (G)
  - d. Visible Light (RGB)
  - e. Red (R)
  - f. Blue (B)
2. Downward Vision System
3. Micro USB Port
4. Camera/Linking Status Indicator and Link Button
5. Camera microSD Card Slot
6. Forward Vision System
7. Infrared Sensing System
8. Front LEDs
9. Motors
10. Propellers
11. Aircraft Status Indicators
12. OcuSync Antennas
13. Onboard D-RTK Antenna
14. Spectral Sunlight Sensor
15. Rear Vision System
16. Intelligent Flight Battery
17. Power Button
18. Battery Level Indicators

## Remote Controller Overview

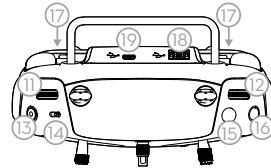
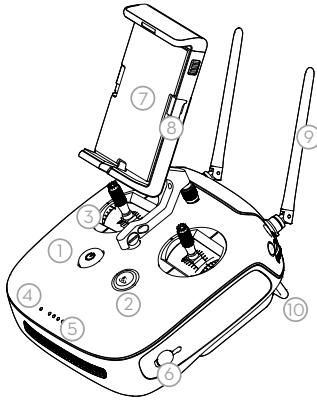

1. Power Button  
Used to turn the remote controller on and off.
2. Return to Home (RTH) Button  
Press and hold this button to initiate RTH.
3. Control Sticks  
Controls aircraft movement. Can be set to Mode 1, Mode 2, or Mode 3.
4. Status LED  
Indicates whether the remote controller is linked to the aircraft.
5. Battery Level LEDs  
Displays the battery level of the remote controller.
6. Power Port  
Connect to the charger to charge the battery of the remote controller.
7. Mobile Device Holder  
Securely mounts your mobile device to the remote controller.
8. Small Device Positioning Tabs (for mobile phones)
9. Antennas  
Relays aircraft control and image transmission signals.
10. Handle Bar
11. Gimbal Dial  
Use this dial to control the tilt of the gimbal.
12. Reserved Dial
13. Video Recording Button  
Press to start recording video. Press again to stop recording.
14. Flight Mode Switch  
The P and S positions on the remote controller are for P-mode, and the A position is for A-mode.
15. Shutter Button  
Press to take a photo. Two-stage button. Pictures will only be taken when the shutter button is fully pressed.
16. Reserved Blank Button
17. C1 and C2 Buttons  
C1: In Camera View, press to switch between RGB imaging and multispectral imaging live views. When switching to multispectral imaging, the default display is NDVI. If NDRE or GNDVI was selected in Display Mode before you switch the live view using this button, the corresponding live view will be displayed.  
C2: If creating a mission using the aircraft location, press once to set the current location of the aircraft as a point.
18. USB Port (for mobile device connection)  
Connection to mobile device for DJI GS Pro.
19. Micro USB Port  
Connects to a computer via a Micro USB cable for configuration.

# Aircraft

---

This section introduces the aircraft components, features and functions.



# Aircraft

## Profile

The P4 Multispectral aircraft includes a flight controller, a communication system, a positioning system, a propulsion system and an Intelligent Flight Battery. This section describes the functions of these components.

## Flight Modes

The P4 Multispectral provides the following flight modes. Use the flight mode switch on the remote controller to switch between different flight modes. The P and S positions on the remote controller are for P-mode, and the A position is for A-mode.

**P-mode (Positioning):** P-mode works best when the GNSS signal is strong. The aircraft utilizes the GNSS / RTK module and Vision System to automatically stabilize itself and navigate between obstacles. When the GNSS signal is strong, the aircraft uses GNSS for positioning. When RTK module is enabled and the differential data transmission is good, it provides centimeter-level positioning. When the GNSS signal is weak and the lighting conditions are sufficient, the aircraft uses Vision System for positioning. When the forward obstacle sensing is enabled and lighting conditions are sufficient, the maximum flight attitude angle is 25° with a maximum flight speed of 31 mph (50 kph). When forward obstacle sensing is disabled, the maximum flight attitude angle is 35° and the maximum flight speed is 36 mph (58 kph).

**A-mode (Attitude):** GNSS is not used for positioning and the aircraft can only maintain altitude using the barometer.

## Attitude Mode Warning

The aircraft will enter A-mode in the following two instances:

**Passive:** When there is weak GNSS signal or when the compass experiences interference where the Vision System is unavailable.

**Active:** Users toggle the flight mode switch to A-mode.

In A-mode, the Vision System and some advanced features are disabled. Therefore, the aircraft cannot position or auto-brake in this mode and is easily affected by its surroundings, which may result in horizontal shifting. Use the remote controller to position the aircraft.

Maneuvering the aircraft in A-mode can be difficult. Before switching the aircraft into A-mode, make sure you are comfortable flying in this mode. DO NOT fly the aircraft too far away as you might lose control and cause a potential hazard. Avoid flying in confined spaces or in areas where the GNSS signal is weak. Otherwise, the aircraft will enter A-mode, leading to potential flight risks. Land the aircraft in a safe place as soon as possible.

## Aircraft Status Indicators

The P4 Multispectral has Front LEDs and Aircraft Status Indicators. The positions of these LEDs are shown in the figure below:



The Front LEDs show the orientation of the aircraft. The Front LEDs glow solid red when the aircraft is turned on to indicate the front (or nose) of the aircraft. The Aircraft Status Indicators communicate the system status of the flight controller. Refer to the table below for more information about the Aircraft Status Indicators.

### Aircraft Status Indicator Description

#### Normal



..... Alternate red, green and yellow flashing	Turning On and Self Diagnostic Testing
..... Alternate green and yellow flashing	Warming Up
..... Slow green flashing	P-mode with GNSS or RTK
..... Two green flashes	P-mode with Vision System
..... Slow yellow flashing	A-mode but No GNSS or Vision System
..... Fast green flashing	Braking

#### Warning

..... Fast yellow flashing	Remote Controller Signal Lost
..... Slow red flashing	Low Battery Warning
..... Fast red flashing	Critical Battery Warning
..... Red flashing	Uneven Placement or Large Sensors Bias
— Solid red	Critical Error
..... Alternate red and yellow flashing	Compass Calibration Required

## Return to Home (RTH)

Return to Home (RTH) function brings the aircraft back to the last recorded Home Point. There are three types of RTH: Smart RTH, Low Battery RTH, and Failsafe RTH. This section describes these three scenarios in detail.

	GNSS	Description
Home Point		If a strong GNSS signal was acquired before takeoff, the Home Point is the location from which the aircraft launched. The GNSS signal strength is indicated by the GNSS icon (  ). Less than 4 bars is considered a weak GNSS signal). The aircraft status indicators will blink rapidly when the home point is recorded.

 The aircraft can sense and avoid obstacles when the Forward Vision System is enabled and lighting conditions are sufficient. The aircraft will automatically climb up to avoid obstacles and descend slowly as it returns to the Home Point. To ensure the aircraft returns home forwards, it cannot rotate or fly left and right during RTH while the Forward Vision System is enabled.

### Failsafe RTH

The Forward Vision System allows the aircraft to create a real-time map of its flight route as it flies. If the Home Point was successfully recorded and the compass is functioning normally, Failsafe RTH will be automatically activated if the remote controller signal is lost for more than three seconds. The aircraft will plan its return route and retrace its original flight route home. During RTH, if the remote controller signal is recovered, users can control the aircraft altitude and speed. Press the RTH button once to cancel RTH.

#### Failsafe Illustration

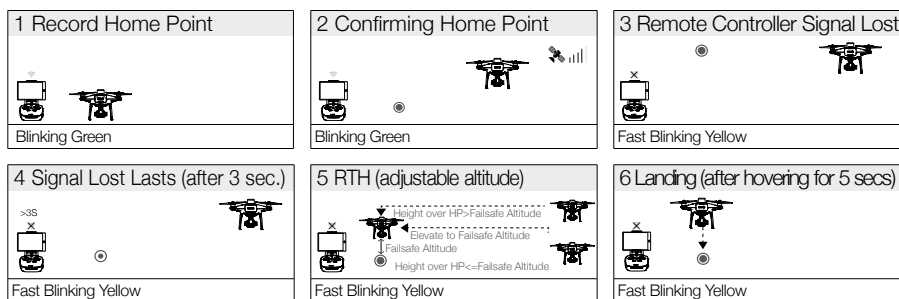

### Smart RTH

Use the RTH button on the remote controller when GNSS is available to initiate Smart RTH. The aircraft will then automatically return to the last recorded Home Point. Use the remote controller to control the aircraft's speed or altitude to avoid a collision during the Smart RTH process. As the aircraft returns, it will use the primary camera to identify obstacles as far as 300m in front, allowing it to plan a safe route home. Press and hold the Smart RTH button once to start the process, and press the Smart RTH button again to terminate the procedure and regain full control of the aircraft.

## Low Battery RTH

The low battery level failsafe is triggered when the DJI Intelligent Flight Battery is depleted to a point that may affect the safe return of the aircraft. The user can cancel the RTH procedure by pressing the RTH button on the remote controller. The thresholds for these warnings are automatically determined based on the aircraft's current altitude and distance from the Home Point. The Low Battery RTH will only be triggered once during the same flight.

The aircraft will land automatically if the current battery level can only support the aircraft long enough to descend from its current altitude. The user cannot cancel the auto landing but can use the remote controller to alter the aircraft's orientation during the landing process.

The Battery Level Indicator is displayed in DJI GS Pro, and is described below:

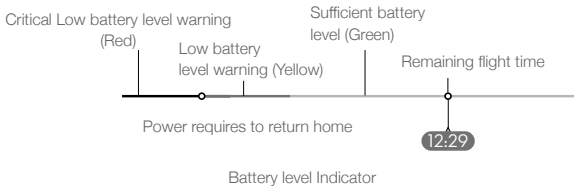

Battery Level Warning	Remark	Aircraft Status Indicator	DJI GS Pro	Flight Instructions
Low battery level warning	Battery power is low. Fly the aircraft back.	Aircraft status indicator blinks RED slowly.	N/A	The aircraft will return to the Home Point automatically and hover at 2 meters above the Home Point. Users can also cancel the RTH process and land manually. Note: The Low Battery Level Warning will not prompt after users cancel RTH and regain control.
Critical Low battery level warning	The aircraft must land immediately.	Aircraft status indicator blinks RED quickly.	DJI GS Pro display will flash red and the aircraft will start to descend. The remote controller will sound an alarm.	Allow the aircraft to descend and land automatically.
Estimated remaining flight time	Estimated remaining flight based on current battery level.	N/A	N/A	N/A



- ☀️ • When the Critical low battery level warning is triggered and the aircraft begins to land automatically, push the left stick upward to make the aircraft hover at its current altitude, giving you an opportunity to navigate to a more appropriate landing location.
- The colored zones and markers on the battery level indicator bar reflect the estimated remaining flight time. They are automatically adjusted according to the aircraft's current location and status.
- The Low Battery Warning threshold set in the Aircraft Battery settings page in the app is only for an alert and will not trigger RTH.

### Precision Landing

The aircraft automatically scans and attempts to match the terrain features underneath during Return to Home. When current terrain matches home point terrain, the aircraft will start landing immediately to achieve precision landing.

- ⚠️ • Landing Protection is active during precision landing.
- Precision Landing performance is subject to the following conditions:
  - a) Home point is recorded upon take off, and cannot not be refreshed during flight.
  - b) Aircraft must take off vertically. Take off altitude must be greater than 7 meters.
  - c) Home point terrain features remain largely unchanged.
  - d) Home point terrain with no distinctive features will affect the performance.
  - e) Lighting conditions cannot be too light nor too dark.
- The following actions are available during landing:
  - a) Pull throttle down to accelerate landing.
  - b) Moving the control sticks in any other direction will stop Precision Landing. The aircraft will descend vertically and Landing Protection will remain active.

### RTH Safety Notices



The aircraft cannot avoid obstruction during RTH when the Forward Vision System is disabled. Users can use the remote controller to control aircraft altitude and speed. It is important to set a suitable Failsafe altitude before each flight. Go to Camera View in DJI GS Pro, tap the text under the Smart RTH button to set an RTH altitude.



If the aircraft is flying under 65 feet (20 meters) and RTH (including Smart RTH, Low Battery RTH and Failsafe RTH) is triggered, the aircraft will first automatically ascend to 65 feet (20 meters) from the current altitude. You can only cancel the ascending by exiting the RTH.



The aircraft will automatically descend and land if RTH is triggered when the aircraft flies within a 16-foot (5 meters) radius of the Home Point and when the aircraft altitude is under 98 feet (30 meters), or if the obstacle sensing function is disabled. The aircraft will not ascend, and will land immediately at the current location.



Aircraft cannot return to the Home Point when GNSS signal is weak ( [ 📶 ] displays grey) or the module is unavailable.



If you move the throttle stick after the aircraft rises above 65 feet (20 meters) but below the pre-set Failsafe RTH altitude, the aircraft will stop ascending and immediately return to the Home Point.

### Obstacle Avoidance During RTH

Aircraft can now sense and actively attempt to avoid obstacles during RTH, provided that the lighting conditions are adequate for the Forward Vision System. Upon detecting an obstacle, the aircraft will act as follows:

1. The aircraft will use the primary camera to identify obstacles as far as 984 feet (300 meters) in front, allowing it to plan a safe route home.
2. The aircraft decelerates when an obstacle is sensed at 49 feet (15 meters) ahead.
3. The aircraft stops and hovers then starts ascending vertically to avoid the obstacle. Eventually, the aircraft will stop climbing when it is at least 16 feet (5 meters) above the detected obstacle.
4. Failsafe RTH procedure resumes, the aircraft will continue flying to the Home Point at the current altitude.

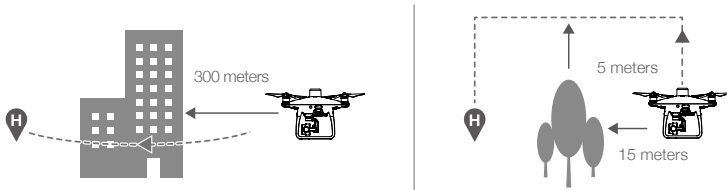

- The Obstacle Sensing function is disabled during RTH descent. Operate with care.
- To ensure the aircraft returns home forwards, it cannot rotate during RTH while the Forward Vision System is enabled.
- The aircraft cannot avoid obstacles above, beside, or behind the aircraft.

### Landing Protection Function

Landing Protection will activate during auto landing.

1. Landing Protection determines whether the ground is suitable for landing. If so, the aircraft will land gently.
2. If Landing Protection determines that the ground is not suitable for landing, the aircraft will hover and wait for pilot confirmation. The aircraft will hover if it detects the ground is not appropriate for landing even with a critically low battery warning. Only when the battery level

decreases to 0% will the aircraft land. Users retain control of aircraft flight orientation.

3. If Landing Protection is inactive, DJI GS Pro will display a landing prompt when the aircraft descends below 0.3 meters. Tap to confirm or pull down the control stick for 2 seconds to land when the environment is appropriate for landing.



- Landing Protection will not be active in the following circumstances:
    - a) When the user is controlling the pitch/roll/throttle sticks (Landing ground detection will re-activate when control sticks are not in use)
    - b) When the positioning system is not fully functional (e.g. drift position error)
    - c) When the Downward Vision System needs re-calibration
    - d) When light conditions are not sufficient for the Downward Vision System
  - If an obstacle is within 1-meter of the aircraft, the aircraft will descend to 0.3m above the ground and hover. The aircraft will land upon with user confirmation.
- 

## Aerial Photography Missions

Create automated flight missions in DJI GS Pro by planning flight paths and setting parameters. Refer to the DJI GS Pro User Manual for details on flight planning and mission execution. The following section will guide you on how to set the parameters for both RGB imaging and multispectral imaging, as well as the storage of the photos.

### Camera Settings

Go to Camera View in the app, and tap  to enter camera settings.

In , configure RGB imaging settings and multispectral imaging settings.

RGB imaging settings:

Camera View will display an RGB image during configuration.

1. Select between Auto and Manual mode. Users can adjust ISO and shutter values when Manual mode is selected.
2. Set the exposure value (EV).

Multispectral imaging settings:

Camera View will display a multispectral image in real time during configuration. In the parameters list, the wavelength for each imaging band and its corresponding gain will be displayed. Currently, NDVI, GNDVI, and NDRE index maps are supported. Users can select the desired index map in Display Mode. Refer to the section below for more information.

1. Select between Auto and Manual mode. Users can adjust the shutter value when Manual mode is selected.
2. Set EV.



- When multispectral camera is selected in Camera View for a mission, this mission will not capture RGB photos, which are required for 2D multispectral map reconstruction in DJI GS Pro or DJI Terra. It is recommended to select visible camera in Camera View before starting the mission to ensure RGB images are collected for reconstruction in DJI GS Pro or DJI Terra.
  - When configuring parameters for a mission, it is recommended to set the Shooting Angle to Course Aligned to ensure mapping accuracy.
-

In , set the capture mode, bands to be stored, display mode, and color map.

Capture mode:

Select between single shot and timed shot. The minimum time interval of timed shot can be set to 1 s.



When the time interval is set to 1 s, a microSD card with a write speed of at least 50 MB/s is required, such as the microSD card that comes with the aircraft. With this setting, a maximum of 3 bands of images (JPEG\*1 + TIFF\*2) can be stored, and the images cannot be used for reconstruction in DJI Terra.

Bands to be stored:

Choose which spectral band photos to save according to the application.

When configuring visible imaging settings, users can select RGB, BLUE, GREEN, RED, RE, and NIR.

When configuring multispectral imaging settings, users can select NDVI, BLUE, GREEN, RED, RE, and NIR.

Only the photos of the selected bands will be saved. At least one band should be selected.

Display mode: Select between RGB, NDVI, GNDVI, and NDRE.

Color map:

Set the rendered display color scale and value range in the live view according to the numerical value of the vegetation index.

1. Select the color map between Default, Spectral, and RdYIGn. View the corresponding color bar located above the option. The Default color scheme is favorable for recognition between vegetation and other objects. The Spectral color scheme is similar to a thermal image. For RdYIGn, this color scheme is able to meet the human visual system for vegetation, aptly.
2. For each color map option, users can select the value range for the rendered display color scale of the vegetation index between Default, Auto, and Custom. The Default range is [-1, 1]. Auto means that the range is determined by the min and max values in the images from the cameras. Custom means that the range can have adjustable min and max values, and users can set the min and max values in a range of [-1, 1] respectively, according to their requirements.



If observation for the changes of the vegetation index in a certain area at different periods for a long time (through real-time image transmission) is required, it is recommended to use the Custom option to set the value range. If observation for vegetation growth in a large area at a specific period is required, without comparison between different periods, the Auto option is recommended.

## Photos Storage

Depending on the bands selected, up to 6 photos will be taken and saved every time. The photo for each band in the group has its own file name. The naming rule is "DJI\_XXX". XXX refers to the number of the photo group. Y, with a value of 0 to 5, corresponds to different imaging bands:

Y	0	1	2	3	4	5
Imaging Band	RGB, NDVI, GNDVI, or NDRE, according to the selected display mode	BLUE	GREEN	RED	RE	NIR

## Generating Multispectral Maps

Import the image data into DJI GS Pro or DJI Terra to generate multispectral maps. Refer to their user manuals for details.

## RTK Functions

The P4 Multispectral has a built-in DJI Onboard D-RTK, which provides more accurate data for centimeter-level positioning to improve operation precision when using with the DJI D-RTK 2 High Precision GNSS Mobile Station or Network RTK service. The onboard D-RTK, providing precision position and speed information combined with optimized algorithms, is more accurate than a standard compass sensor and functions even with magnetic interference from metal structures, ensuring stable flight. If the RTK signal is weak and differential data cannot be transmitted during a mission, users can read the raw satellite observations\* recorded in the microSD card in the aircraft after the flight, and then use PPK technology to achieve centimeter-level positioning.

\* Supported later.

### Using with the DJI D-RTK 2 Mobile Station

1. Go to Mission Page in DJI GS Pro, tap the  icon or RTK on top of the screen to go to the RTK settings menu, and then select D-RTK 2 as the RTK data source. Enable the aircraft RTK at the bottom of the menu to ensure the aircraft has access to RTK data.
2. Tap Link. The remote controller will start beeping. Then press the link button on the mobile station.
3. Tap Connect to establish connection with the server. Wait for the RTK icon to display FIX, indicating that the differential data calculation is completed and the aircraft can use RTK for positioning.

### Using with Network RTK Service

The Network RTK service uses the remote controller instead of the base station to connect to an approved Network RTK server to send and receive differential data. Keep the remote controller on and the mobile device connected to the internet when using this function.

1. Ensure that the remote controller is connected to the aircraft and the mobile device has access to the Internet.
2. Go to Mission Page in DJI GS Pro, tap the  icon or RTK on top of the screen to go to the RTK settings menu, and then select Network RTK Account as the RTK data source.
3. Tap New in the Network RTK Account setting page. After configuration, go back to the settings menu to select the added account.
4. Enable the aircraft RTK at the bottom of the menu to ensure the aircraft has access to RTK data.
5. Tap Connect to establish connection with the server. Wait for the RTK icon to display FIX, indicating that the differential data calculation is completed and the aircraft can use RTK for positioning.

## Vision System and Infrared Sensing System

The main components of the Vision System are located on the front, rear and bottom of the aircraft, including [1] [2] [4] three stereo vision sensors and [3] two ultrasonic sensors. The Vision System uses ultrasound and image data to help the aircraft maintain its current position, enabling precision hovering indoors or in environments where a GNSS signal is not available. The Vision System constantly scans for obstacles, allowing the aircraft to avoid them by going over, around, or hovering.

The Infrared Sensing System consists [5] of two 3D infrared modules on both sides of the aircraft. These scan for obstacles on both sides of the aircraft and is active in certain flight modes.

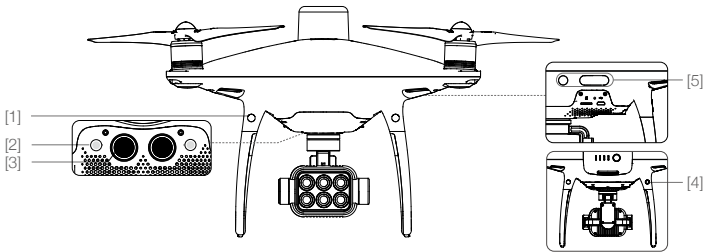

### Detection Range

The detection range of the Vision System and Infrared Sensing System are depicted as follow. Note that the aircraft cannot sense and avoid the obstacles that are not within the detection range.

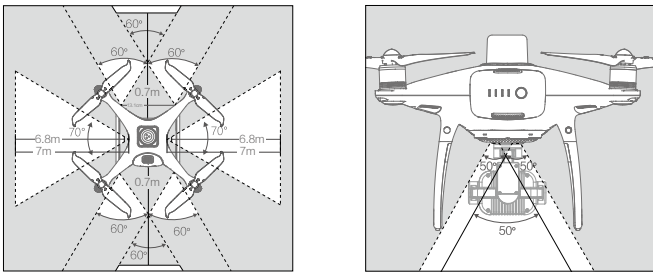

**⚠** In P-mode, both the forward and the rear Vision Systems work if the speed is within 13mph (22kph). At higher speeds, only the vision system facing the direction of travel is active.

### Calibrating Sensors

Vision Systems cameras installed on the aircraft are calibrated on delivery. However these cameras are vulnerable to excessive impact and will require occasional calibration via DJI Assistant 2 for Phantom. Follow the steps below to calibrate the sensors.

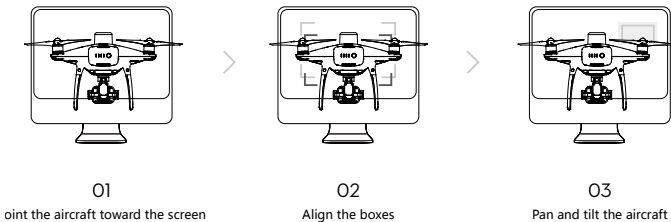

### Using Vision Positioning

Vision Positioning is activated automatically when the aircraft is turned on. No further action is required. Vision Positioning is typically used in indoor environments, where GNSS is unavailable.

Using the sensors that are built into the Vision System, the aircraft can hover precisely even without GNSS. The Downward Vision System works best when the aircraft is at altitudes of under 33 ft (10 m). Operate the aircraft with great caution when flying at high speeds at low altitudes (under 0.5 m).

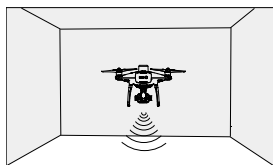

Follow the steps below to use Vision Positioning:

1. Turn on the aircraft. The aircraft status indicator will flash green two times, which indicates the Vision Positioning is ready.
2. Gently push the left stick up to lift off and the aircraft will hover in place.

### Assisted Braking from Obstacle Sensing

Powered by the Obstacle Sensing, the aircraft will now be able to actively brake when obstacles are detected around the aircraft. Note that Obstacle Sensing function works best when lighting is adequate and the obstacle is clearly marked or textured. The aircraft must fly at no more than 31mph (50kph) to allow sufficient braking distance.

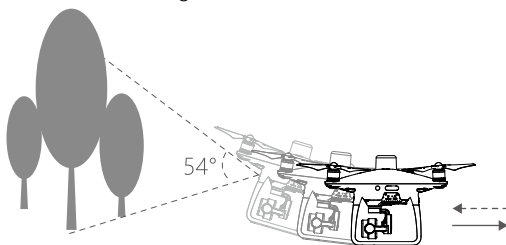

- The 3D Infrared Sensing System is only active in Beginner mode\* and Tripod mode\*. Fly with caution.
- The performance of your Vision System and Infrared Sensing System are affected by the surface being flown over. Ultrasonic sensors may not be able to accurately measure distances when operating above sound-absorbing materials and the camera may not function correctly in suboptimal environments. The aircraft will switch from P-mode to A-mode automatically if neither vision sensors nor ultrasonic sensors and Infrared Sensing System are available. Operate the aircraft with great caution in the following situations:
  - a) Flying over monochrome surfaces (e.g. pure black, pure white, pure red, pure green).
  - b) Flying over a highly reflective surfaces.
  - c) Flying at high speeds of over 31mph (50kph) at 2 meters or over 11mph (18kph) at 1 meter.
  - d) Flying over water or transparent surfaces.
  - e) Flying over moving surfaces or objects.
  - f) Flying in an area where the lighting changes frequently or drastically.
  - g) Flying over extremely dark (lux < 10) or bright (lux > 100,000) surfaces.
  - h) Flying over surfaces that can absorb sound waves (e.g. thick carpet).
  - i) Flying over surfaces without clear patterns or texture.
  - j) Flying over surfaces with identical repeating patterns or textures (e.g. tiling).

---

\* This mode will be supported later.

- ⚠ k) Flying over inclined surfaces that will deflect sound waves away from the aircraft.
- l) Flying over obstacles with too small effective infrared reflective surface.
- m) DO NOT position the sides of two aircraft toward each other to avoid interference between the 3D infrared modules.
- n) DO NOT cover the protective glass of the infrared module. Keep it clean and undamaged.
- o) Flying at high speed at low altitude (under 0.5 m).





- ☀ • Keep sensors clean at all times. Dirt or other debris may adversely affect their effectiveness.
- Vision Positioning is only effective when the aircraft is at altitudes of 0.3 to 10 meters.
- The Vision Positioning may not function properly when the aircraft is flying over water.
- The Vision System may not be able to recognize pattern on the ground in low light conditions (less than 100 lux).
- Do not use other ultrasonic devices with frequency of 40 kHz when Vision System is in operation.

## Flight Recorder

Flight data is automatically recorded to the internal storage of the aircraft. To access this data, connect the aircraft to the PC through the Micro USB port and launch the DJI Assistant 2.

## Attaching and Detaching the Propellers

Use only DJI approved propellers with your aircraft. The grey and black ring on the propeller indicate where they should be attached and in which direction they should spin.

Propellers	Silver Ring	Black Ring
Figure		
Attach On	Motors without black dots	Motors with black dots
Legends	<p> Lock : Turn the propellers in the indicated direction to mount and tighten.</p> <p> Unlock : Turn the propellers in the indicated direction to loosen and remove.</p>	

### Attaching the Propellers

1. Be sure to remove the warning stickers from the motors before attaching the propellers.
2. Mount the propellers with black propeller rings to the motors with black dots. Mount the propellers with silver propeller rings to the motors without black dots. Press the propeller down onto the mounting plate and rotate in the lock direction until it is secured in its position.





## Detaching the Propellers

Press the propellers down into the motor mount and rotate in the unlock direction.

---



- Be aware of the sharp edges of the propellers. Handle with care.
  - Use only the DJI approved propellers. Do not mix propeller types.
  - Check that the propellers and motors are installed correctly and firmly before every flight.
  - Ensure that all propellers are in good condition before each flight. DO NOT use aged, chipped, or broken propellers.
  - To avoid injury, STAND CLEAR of and DO NOT touch propellers or motors when they are spinning.
  - ONLY use original DJI propellers for a better and safer flight experience.
- 

## DJI Intelligent Flight Battery

The DJI Intelligent Flight Battery has a capacity of 5870 mAh, a voltage of 15.2 V, and a smart charge/discharge functionality. It should only be charged using an appropriate DJI approved power adapter and charging hub.

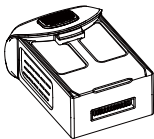

Intelligent Flight Battery

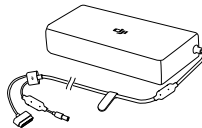

AC Power Adapter

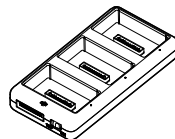

Charging Hub

---



- The Intelligent Flight Battery must be fully charged before using it for the first time.
  - Never insert or remove the battery when it is turned on.
  - Ensure the battery is mounted firmly. The aircraft will not take off if the battery is mounted incorrectly.
- 

## DJI Intelligent Flight Battery Functions

1. Battery Level Display: The LED indicators display the current battery level.
2. Auto-Discharging Function: To prevent swelling, the battery automatically discharges to below 65% of total power when it is idle for more than ten days. It takes around two days to discharge the battery to 65%. It is normal to feel moderate heat being emitted from the battery during the discharge process.
3. Balanced Charging: Automatically balances the voltage of each battery cell when charging.
4. Overcharge Protection: Charging automatically stops when the battery is fully charged.
5. Temperature Detection: The battery will only charge when the temperature is between 5°C (41°F) and 40°C (104°F).
6. Over Current Protection: The battery stops charging when a high amperage (more than 8 A) is detected.
7. Over Discharge Protection: To prevent over-discharge damage, discharging automatically stops when the battery voltage reaches 12 V.

8. Short Circuit Protection: Automatically cuts the power supply when a short circuit is detected.
9. Battery Cell Damage Protection: DJI GS Pro displays a warning message when a damaged battery cell is detected.
10. Sleep Mode: To save power, the battery enter sleep mode after 20 minutes of inactivity.
11. Communication: Information pertaining to the battery's voltage, capacity, current, etc. is transmitted to the aircraft's main controller.

---

**⚠** Refer to Phantom 4 Series Intelligent Flight Battery Safety Guidelines before use. Users take full responsibility for all operations and usage.

---

## Using the Battery

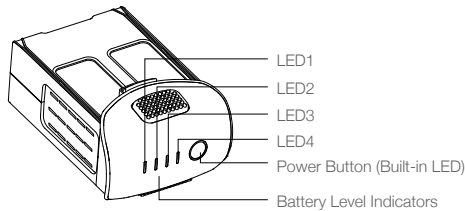

### Turning ON/OFF

**Turning On:** Press the Power Button once, then press again and hold for 2 seconds to turn on. The Power LED will turn green and the Battery Level Indicators will display the current battery level.

**Turning Off:** Press the Power Button once, then press again and hold for 2 seconds to turn off. The battery power LED will flash when powering off the Phantom to allow automatically stopping of a recording during the event recording wasn't stopped.

### Low Temperature Notice:

1. Battery capacity is significantly reduced when flying in low temperature ( $< 0^{\circ}\text{C}$ ) environments.
2. It is not recommended that the battery be used in extremely low temperature ( $< -10^{\circ}\text{C}$ ) environments. Battery voltage should reach the appropriate level when operating environment with temperatures between  $-10^{\circ}\text{C}$  and  $5^{\circ}\text{C}$ .
3. End the flight as soon as DJI GS Pro displays the "Low Battery Level Warning" in low temperature environments.
4. Keep the battery indoors to warm it before flying in low temperature environments.
5. To ensure optimal performance of the battery, keep the battery temperature above  $20^{\circ}\text{C}$ .
6. The charger will stop charging the battery if the battery cell's temperature is not within the operating range ( $0^{\circ}\text{C} \sim 40^{\circ}\text{C}$ ).

---

**⚠** In cold environments, insert the battery into the battery compartment and turn on the aircraft for approximately 1-2 minutes to warm up before taking off.

---





































### Checking the Battery Level

The Battery Level Indicators display how much power remains. When the battery is turned off, press the Power Button once. The Battery Level Indicators will light up to display the current battery level. See below for details.

 The Battery Level Indicators will also show the current battery level during charging and discharging. The indicators are defined below.

-  : LED is on.
-  : LED is flashing.
-  : LED is off.

#### Battery Level Indicators

LED1	LED2	LED3	LED4	Battery Level
				87.5%~100%
				75%~87.5%
				62.5%~75%
				50%~62.5%
				37.5%~50%
				25%~37.5%
				12.5%~25%
				0%~12.5%
				=0%

### Charging the Intelligent Flight Battery

-  • Air cool the Intelligent Flight Battery after each flight. Allow its temperature to drop to room temperature before charging.
- The charging temperature range is 5° to 40° C. The battery management system will stop the battery from charging when the battery cell temperature is out of range.
- Always turn off the battery before inserting it or removing it from the aircraft. Never insert or remove a battery when it is turned on.

#### Using only the Power Adapter for Charging

1. Connect the AC power adapter to a power source (100-240 V 50/60 Hz).
2. Connect the Intelligent Flight Battery to the power adapter to start charging. If the battery level is above 95%, turn on the battery before charging.
3. The Battery Level Indicator will display the current battery level as it is charging.
4. The Intelligent Flight Battery LED is fully charged when the Battery Level Indicators are all off.

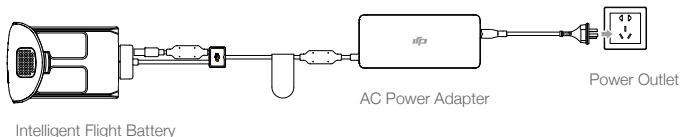

### Battery Level Indicators While Charging

LED1	LED2	LED3	LED4	Battery Level
				0%~25%
				25%~50%
				50%~75%
				75%~100%
				Fully Charged

### Using the Power Adapter and Charging Hub for Charging

#### 1. Connecting to a Power Source

Connect the power adapter to a power outlet (100-240V, 50/60Hz), then connect the charging hub to the power adapter.

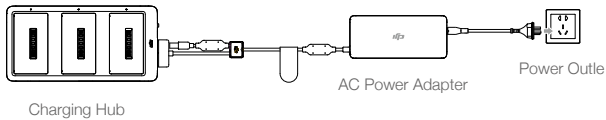

#### 2. Connecting Batteries

##### Charging Mode:

Align the grooves on the Intelligent Flight Battery with the battery slot tracks to insert the battery and begin charging. The Intelligent Flight Battery with the highest power level will be charged first. Other batteries will be charged in sequence according to their power levels.

If the Status LED Indicator of the charging hub is solid green and the LED lights on the Intelligent Flight Battery turn off, charging is complete and the Intelligent Flight Battery can be disconnected from the charging hub.

##### Storage Mode:

The charging hub will discharge batteries with more than 50% power to reduce the charge to 50%. Meanwhile batteries with less than 50% charge will be charged to 50%.

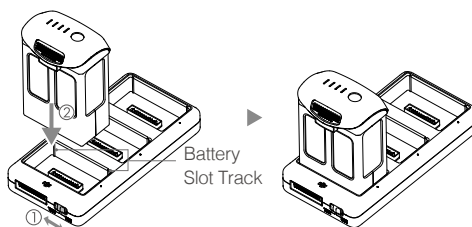

- ⚠ Be sure to align the grooves on the Intelligent Flight Battery with the battery slot tracks. The Status LED Indicator will turn solid yellow if the battery is properly inserted.
- In storage mode, you can power on the Intelligent Flight Batteries to discharge them without having to connect to a power source if all batteries have more than 50% power.

### Status LED Indicator Description

Status LED Indicator	Description
Charging Mode	
— Solid Yellow	Queuing to charge
..... Blinking Green	Charging
— Solid Green	Fully charged
— Solid Red	No battery detected
..... All Blinking Red	Power supply error, please check the connection to the Battery Charger
Storage Mode	
— Solid Yellow	Ready to charge or discharge
..... Blinking Blue	Charging or discharging
— Solid Blue	The battery's power level is 50%
— Solid Red	No battery detected
..... All Blinking Red	Power supply error, please check the connection to the Battery Charger

### Battery Protection LED Display

The table below shows battery protection mechanisms and corresponding LED patterns.

Battery Level Indicators while Charging					
LED1	LED2	LED3	LED4	Blinking Pattern	Battery Protection Item
				LED2 blinks twice per second	Over current detected
				LED2 blinks three times per second	Short circuit detected
				LED3 blinks twice per second	Over charge detected
				LED3 blinks three times per second	Over-voltage charger detected
				LED4 blinks twice per second	Charging temperature is too low
				LED4 blinks three times per second	Charging temperature is too high

After these issues are resolved, press the Power Button to turn off the Battery Level Indicator. Unplug the Intelligent Flight Battery from the charger and plug it back in to resume charging. Note that you do not need to unplug and plug in the charger in the event of a room temperature error; the charger will resume charging when the temperature is within the allowable range.



- DJI does not take any responsibility for damage caused by third-party chargers.
  - If the battery level is above 95%, turn on the battery before charging.
- 



How to discharge your Intelligent Flight Battery:

Place the Intelligent Flight Battery into the battery compartment and turn it on. Fly the aircraft out doors until the battery level is low (such as 20% of power left).

---

# Gimbal Cameras

---

This section provides the technical specifications of the cameras and explains the gimbal operation.

# Gimbal Cameras

## Cameras

### Profile

The P4 Multispectral imaging system contains six cameras with 1/2.9-inch CMOS sensors, including an RGB camera that produces images in the JPEG format and a multispectral camera array containing five cameras that produce multispectral images in the TIFF format. It uses a global shutter to ensure performance.

The five cameras in the multispectral camera array can capture photos in the following imaging bands: Blue (B): 450 nm  $\pm$  16 nm; Green (G): 560 nm  $\pm$  16 nm; Red (R): 650 nm  $\pm$  16 nm; Red edge (RE): 730 nm  $\pm$  16 nm; Near-infrared (NIR): 840 nm  $\pm$  26 nm.

### Camera microSD Card Slot

The P4 Multispectral supports microSD cards up to 128 GB. A Class 10 or UHS-I and above microSD card is recommended due to their fast read and write speeds. Users can read the photos and videos, and the raw satellite observations recorded during missions from the microSD card.

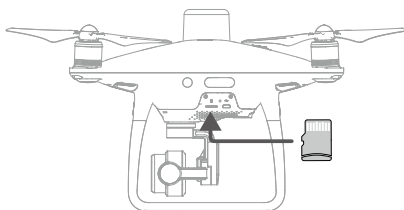

---

⊘ Do not remove the microSD card from the aircraft when it is shooting.

---

⚡ To ensure the stability of the camera system, single video recordings are capped at 30 minutes.

---

### Micro USB Port

Turn on the aircraft and connect a Micro USB cable to the Micro USB Port to update firmware, read the photos and videos, and the raw satellite observations recorded during missions.

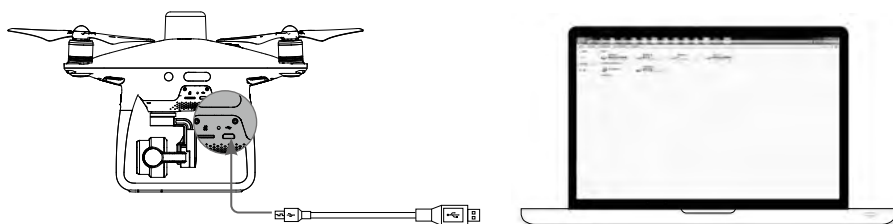



## Camera Operation

Use the shutter and video recording buttons on the remote controller or in DJI GS Pro to shoot the photos or videos.

## Gimbal

### Profile

The 3-axis gimbal provides a steady platform for the attached camera, allowing you to capture clear, stable images and video. Turn the dial to adjust the gimbal pitch angle.

The controllable range of the pitch angle is  $-90^{\circ}$  to  $+30^{\circ}$ . The range is  $-90^{\circ}$  to  $0^{\circ}$  when configuring parameters for a mission in DJI GS Pro, but the gimbal can be controlled manually to  $+30^{\circ}$  using the gimbal dial.

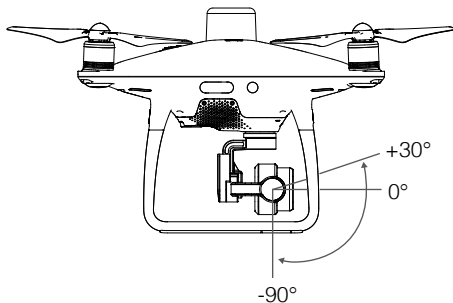

- A gimbal motor error may occur in these situations:
  - (1) the aircraft is placed on uneven ground or the gimbal's motion is obstructed.
  - (2) the gimbal has been subjected to an excessive external force, such as a collision. Please take off from flat, open ground and protect the gimbal at all times.
- Flying in heavy fog or clouds may make the gimbal wet, leading to temporary failure. The gimbal will recover full functionality after it dries.
- It is normal for the gimbal to produce a short beeping tone upon initialization.

# Remote Controller

---

This section describes the features of the remote controller and includes instructions for controlling the aircraft and cameras.

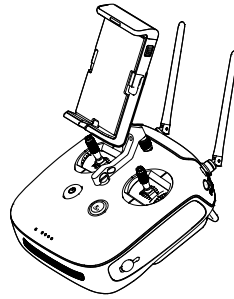

# Remote Controller

## Profile

The remote controller features DJI's long-range transmission technology OcuSync that is capable of controlling the aircraft and the gimbal cameras at a maximum transmission range of 4.3 mi (7 km). Connect an iPad to the remote controller via the USB port to use DJI GS Pro app to plan and perform missions. Export the captured images for analysis and create multispectral maps.



- **Compliance Version:** The remote controller is compliant with local compliance and regulations.
- **Operating Mode:** Control can be set to Mode 1 or Mode 2, or to a custom mode.
- **Mode 1:** The right stick serves as the throttle.
- **Mode 2:** The left stick serves as the throttle.



To prevent transmission interference, do not operate more than three aircrafts in the same area.

## Using the Remote Controller

### Turning the Remote Controller On and Off

The P4 Multispectral remote controller is powered by a 2S rechargeable battery that has a capacity of 6000 mAh. The battery level is indicated via the Battery Level LEDs on the front panel. Follow the steps below to turn on your remote controller:

1. When the remote controller is turned off, press the Power Button once. The Battery Level LEDs will display the current battery level.
2. Press and hold the Power Button to turn on the remote controller.
3. The remote controller will beep when it is turned on. The Status LED will rapidly blink green, indicating that the remote controller is linking to the aircraft. The Status LEDs will glow solid green when linking is complete.
4. Repeat Step 2 to turn off the remote controller.

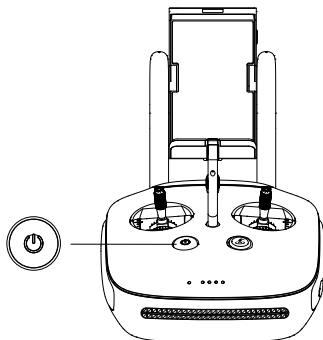

## Charging the Remote Controller

Charge the remote controller using the included charger. Refer to the figure below for more details.

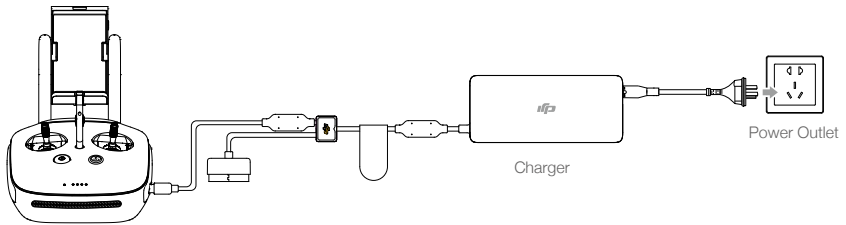

## Controlling the Camera

Shoot videos/photos, and adjust gimbal pitch angle via the Shutter Button, Video Recording Button, and Gimbal Dial on the remote controller.

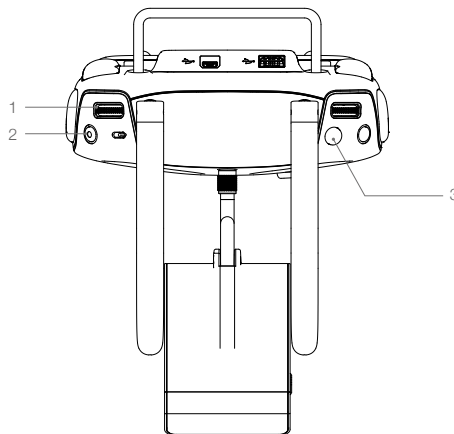

### 1. Gimbal Dial

Control the tilt of the gimbal. Turn left to tilt the gimbal upward and right to tilt the gimbal downward.

### 2. Video Recording Button

Press once to start recording video, then press again to stop recording.

### 3. Shutter Button

Press to take a photo. Two-stage button. Pictures will only be taken when the shutter button is fully pressed.

## Controlling the Aircraft

This section explains how to control the orientation of the aircraft through the remote controller. Control can be set to Mode 1, Mode 2 or Mode 3, or to a custom mode.

### Mode 1

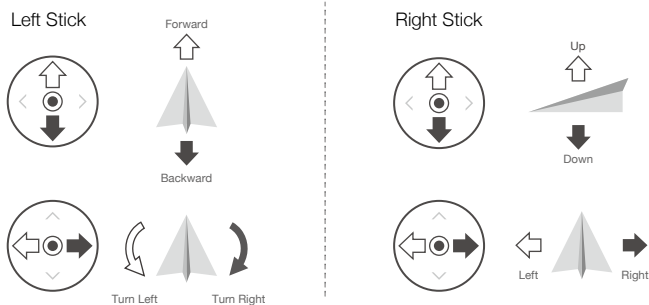

### Mode 2

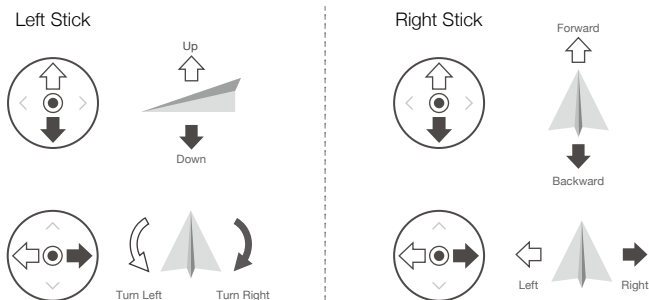

### Mode 3

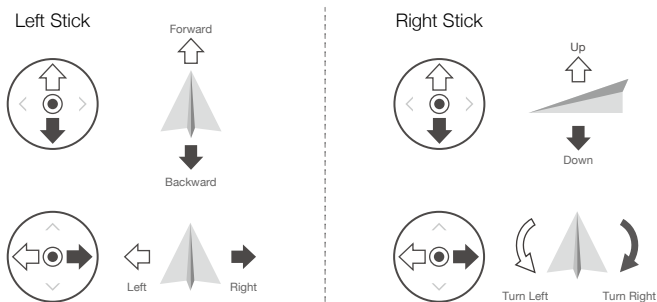





The remote controller is set to Mode 2 by default.

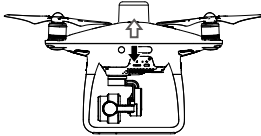

Stick Neutral/Mid-Point: Control sticks are in the center position.

Moving the Control Stick: The control stick is pushed away from the center position.

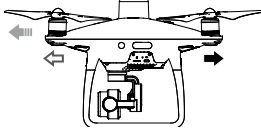
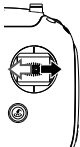
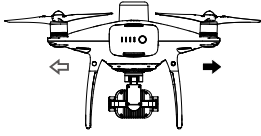
Remote Controller (Mode 2)	Aircraft ( ← Indicates Nose Direction)	Remarks
		<p>Moving the left stick up and down changes the aircraft's elevation.</p> <p>Push the stick up to ascend and down to descend.</p> <p>When both sticks are centered, the P4 Multispectral will hover in place.</p> <p>The more the stick is pushed away from the center position, the faster the P4 Multispectral will change elevation. Always push the stick gently to prevent sudden and unexpected elevation changes.</p>
		<p>Moving the left stick to the left or right controls the rudder and rotation of the aircraft.</p> <p>Push the stick left to rotate the aircraft counter-clockwise, push the stick right to rotate the aircraft clockwise. If the stick is centered, the P4 Multispectral will maintain its current orientation.</p> <p>The more the stick is pushed away from the center position, the faster the P4 Multispectral will rotate.</p>
		<p>Moving the right stick up and down changes the aircraft's forward and backward pitch.</p> <p>Push the stick up to fly forward and down to fly backward. P4 Multispectral will hover in place if the stick is centered.</p> <p>Push the stick further away from the center position for a larger pitch angle (maximum 30°) and faster flight.</p>
		<p>Moving the right stick control left and right changes the aircraft's left and right pitch.</p> <p>Push left to fly left and right to fly right. The P4 Multispectral will hover in place if the stick is centered.</p>

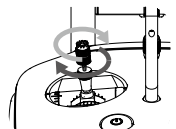

### Adjusting Controller Sticks

Hold and twist the controller sticks clockwise or counter clockwise to adjust the length of the controller sticks. A proper length of controller sticks can improve the controlling accuracy.



## Flight Mode Switch

Toggle the switch to select the desired flight mode. Choose between P-mode and A-mode.

Position	Figure	Flight Mode
Position 1		P-mode
Position 2		P-mode
Position 3		A-mode

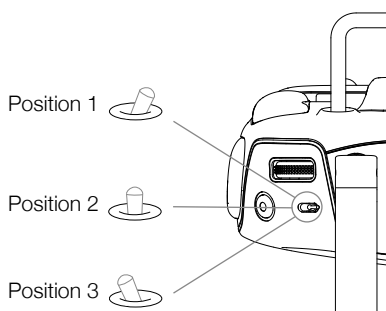

## RTH Button

Press and hold the RTH button to start the Return to Home (RTH) procedure. The LED ring around the RTH Button will blink white to indicate that the aircraft is entering RTH mode. The aircraft will then return to the last recorded Home Point. Press this button again to cancel the RTH procedure and regain control of the aircraft.

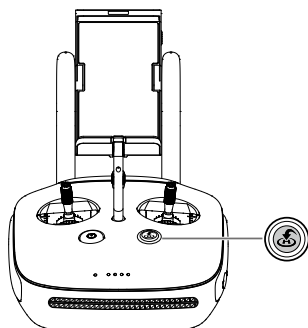

## Optimal Transmission Range

The transmission signal between the aircraft and the remote controller is most reliable within the area that depicted below:

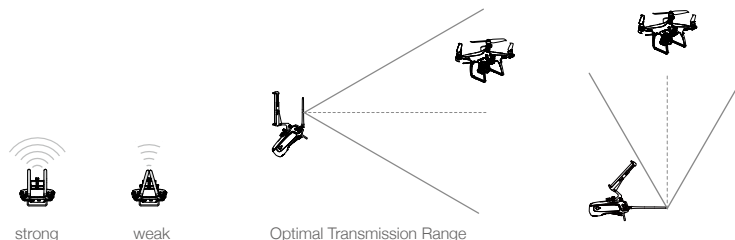

Ensure that the aircraft is flying within the optimal transmission zone. To achieve the best transmission performance, maintain the appropriate relationship between the operator and the aircraft.

## Remote Controller Status LED

The Status LED reflects the strength of the connection between the remote controller and the aircraft. The RTH LED indicates the RTH status of the aircraft. The table below contains more information about these indicators.

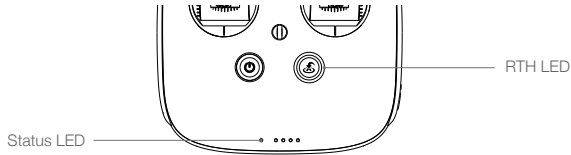

Status LED	Alarm	Remote Controller Status
— Solid Red	Chime	The remote controller is disconnected from the aircraft.
— Solid Green	Chime	The remote controller is connected to the aircraft.
..... Slow Blinking Red	D-D-D.....	Remote controller error.
/  ..... Red and Green/ Red and Yellow Alternate Blinks	None	HD downlink is disrupted.
RTH LED	Sound	Remote Controller Status
— Solid White	Chime	Aircraft is returning home.
..... Blinking White	D . . .	Sending Return-to-Home command to the aircraft.
..... Blinking White	DD . . . .	Return-to-Home procedure in progress.

The Remote Controller Status Indicator will blink red and sound an alert, when the battery level is critically low.

## Linking the Remote Controller

The remote controller should already be linked to the aircraft out of the box. Linking is only required when using a new remote controller for the first time.

1. Power on the remote controller, connect the mobile device, and open DJI GS Pro.
2. Power on the aircraft.
3. In Mission Page, tap , and then tap Start Linking to the right of the Remote Controller Link section.
4. The Status LED blinks blue and the remote controller sounds double beep repeatedly, indicating that the remote controller is ready for linking.
5. Press the link button on the aircraft. Then release and wait for a few seconds. The status LED will glow solid green if linking is successful.



# Flight

---

This section describes safe flight practices and flight restrictions.

# Flight

Once the pre-flight preparation is complete, it is recommended to hone your flight skills through training and practice flying safely. The altitude limit is 1,640 feet (500 meters). Avoid flying at any altitudes higher. It is important to understand basic flight guidelines for the safety of both you and those around you. Refer to the disclaimer and safety guidelines for more information.

## Flight Environment Requirements

1. Do not use the aircraft in severe weather conditions. These include wind speeds exceeding 10 m/s, snow, rain and fog.
2. Only fly in open areas. Tall structures and large metal structures may affect the accuracy of the on-board compass and GNSS system.
3. Avoid obstacles, crowds, high voltage power lines, trees, and bodies of water.
4. Minimize interference by avoiding areas with high levels of electromagnetism, including base stations and radio transmission towers.
5. Aircraft and battery performance is subject to environmental factors such as air density and temperature. Be very careful when flying at altitudes greater than 19,685 feet (6000 meters) above sea level, as the performance of the battery and aircraft may be affected.
6. In the Earth's polar regions the aircraft can only operate in Attitude mode or using vision positioning.

## GEO (Geospatial Environment Online) System

### Introduction

DJI's Geospatial Environment Online (GEO) System is a global information system committed to providing real-time airspace information within the scope of international laws and regulations. GEO provides flight information, flight times and location information to assist Unmanned Aerial Vehicle (UAV) users in making the best decisions related to their personal UAV use. It also includes a unique Regional Flight Restrictions feature which provides real-time flight safety and restriction updates and blocks UAVs from flying in restricted airspace. While safety and obeying air traffic control laws is a paramount concern, DJI recognizes the need for exceptions to be made under special circumstances. To meet this need, GEO also includes an Unlocking feature that enables users to unlock flights within restricted areas. Prior to making their flight, users must submit an unlock request based on the current level of restrictions in their area.

### GEO Zones

DJI's GEO System designates safe flight locations, provides risk levels and safety concerns for individual flights, and offers restricted airspace information, which can be viewed by users in real time on DJI GS Pro. The locations designated by GEO are called GEO Zones. GEO Zones are specific flight areas that are categorized by flight regulations and restrictions. GEO Zones that prohibit flight are implemented around locations such as airports, power plants, and prisons. They can also be temporarily implemented around major stadium events, forest fires, or other emergency situations. Certain GEO Zones do not prohibit flight but do trigger warnings informing users of potential risks. All restricted flight areas are referred to as GEO Zones, and are further divided into

Warning Zones, Enhanced Warning Zones, Authorization Zones, Altitude Zones, and Restricted Zones. By default, GEO limits flights into or taking off within zones that may result in safety or security concerns. There is a GEO Zone Map, which contains comprehensive global GEO Zone information on the official DJI website: <https://www.dji.com/flysafe>.

The GEO System is for advisory purposes only. Individual users are responsible for checking official sources and determining which laws or regulations may apply to their flight. In some instances, DJI has selected widely-recommended general parameters (such as a 1.5-mile radius at airports) without making any determination as to whether these guidelines match regulations that apply to specific users.

### GEO Zone Definitions

**Warning Zones:** Users receive a warning message with information relevant to their flight.

**Enhanced Warning Zones:** Users receive a prompt from the GEO System at the time of flight. They are required to submit an unlock request to fly in the zone, for which they must confirm their flight path.

**Authorization Zones:** Users receive a warning message and the flight is prohibited by default. Authorization Zones can be unlocked by authorized users with a DJI-verified account. Self-Unlocking privileges must be applied for online.

**Altitude Zones:** Flights are limited to a specific altitude.

**Restricted Zones:** Flights are completely prohibited. UAVs cannot fly in these zones. If you have obtained permission to fly in a Restricted Zone, please go to <https://www.dji.com/flysafe> or contact [flysafe@dji.com](mailto:flysafe@dji.com) to unlock the zone.

DJI GEO Zones aim to ensure the user's flight safety, but it cannot be guaranteed to be in full compliance with local laws and regulations. Users should check local laws, regulations, and regulatory requirements before each flight and are responsible for the flight safety.

All intelligent flight features will be affected when DJI aircraft fly nearby or into GEO Zones. Such interference includes, but is not limited to, decreased speed, takeoff failure, and flight termination.

## Flight Restrictions

### Introduction

UAV operators should abide by all flight regulations established by the relevant government and regulatory agencies, including the ICAO and the FAA. For safety reasons, flights are restricted by default, which helps users operate DJI products safely and legally.

When Global Navigation Satellite Service (GNSS) is available, GEO Zones are taken into account to ensure flight safety.

## GEO Zone Flight Restrictions

GEO Zone	Description
Restricted Zone	Takeoff: The aircraft's motors cannot be started.
	In-flight: When GNSS signal changes from weak to strong, DJI GS RTK starts a 20-second countdown. Once the countdown is over, the aircraft immediately lands in semi-automatic descent mode and turns off its motors after landing.
	In-flight: When the aircraft approaches the boundary of the Restricted Zone, it automatically decelerates and hovers.
Authorization Zone	Takeoff: The aircraft's motors cannot be started. Takeoff is only available after submitting an unlock request with the user's phone number.
	In-flight: When GNSS signal changes from weak to strong, DJI GS RTK starts a 20-second countdown. Once the countdown is over, the aircraft immediately lands in semi-automatic descent mode and turns off its motors after landing.
Enhanced Warning Zone	The aircraft flies normally but the user is required to confirm the flight path.
Warning Zone	The aircraft flies normally but the user receives warning messages.
Altitude Zone	When GNSS signal is strong, the aircraft cannot exceed the specified altitude. In-flight: When GNSS signal changes from weak to strong, the aircraft will descend and hover below the altitude limit.
	When the GNSS signal is strong, the aircraft approaches the boundary of the Altitude Zone. If it is higher than the altitude limit, the aircraft decelerates and hovers in place.
	When the GNSS signal changes from weak to strong, DJI GS Pro starts a 20-second countdown. Once the countdown is over, the aircraft will descend and hover below the altitude limit.
Free Zone	The aircraft flies normally with no restrictions.

## GEO Unlocking

Due to differing laws and regulations between countries and regions, and differing flight restrictions between GEO Zones, DJI provides users with two methods for unlocking GEO Zones: Self-Unlocking and Custom Unlocking.

Self-Unlocking is used for Authorization Zones, where the user is required to submit an unlock request by authenticating their phone number for a registered DJI account. This feature is only available in certain countries. Users can choose whether to submit their unlock request via the website at <https://www.dji.com/flysafe> (Scheduled Self-Unlocking), or through DJI GS Pro (Live Self-Unlocking).

Custom Unlocking is based on special requirements for individual users. It sets a special flight area that users can unlock by providing flight permission files according to their specific GEO

Zone and other requirements. It is available in all countries and can be applied for on the website: <https://www.dji.com/flysafe>.

For more information about unlocking, please visit <https://www.dji.com/flysafe> or contact [flysafe@dji.com](mailto:flysafe@dji.com).

## Preflight Checklist

1. Remote controller, Intelligent Flight Battery are fully charged.
2. Propellers are mounted correctly and firmly.
3. MicroSD card has been inserted.
4. Gimbal and camera are functioning normally.
5. Motors can start and are functioning normally.
6. DJI GS Pro is successfully connected to the aircraft.
7. Ensure that the sensors for the Vision System and Infrared Sensing System are clean.

## Calibrating the Compass

Only calibrate the compass when DJI GS Pro or the status indicator prompt you to do so. Observe the following rules when calibrating your compass:



- DO NOT calibrate your compass where there is a chance of strong magnetic interference, such as magnetite, parking structures, and steel reinforcements underground.
  - DO NOT carry ferromagnetic materials with you during calibration such as cellular phones.
  - DJI GS Pro will prompt you to resolve the compass issue if the compass is affected by strong interference after calibration is complete. Follow the prompted instructions to resolve the compass issue.
- 

## Calibration Procedures

Choose an open area to carry out the following procedures.

1. In Mission Page, tap ●●●, Aircraft Settings, , Sensors, then tap Compass Calibration under the Compass section.
2. Hold the aircraft horizontally and rotate 360 degrees. The Aircraft Status Indicators will display a solid green light.
3. Hold the aircraft vertically, with nose pointing downward, and rotate it 360 degrees around the center axis.

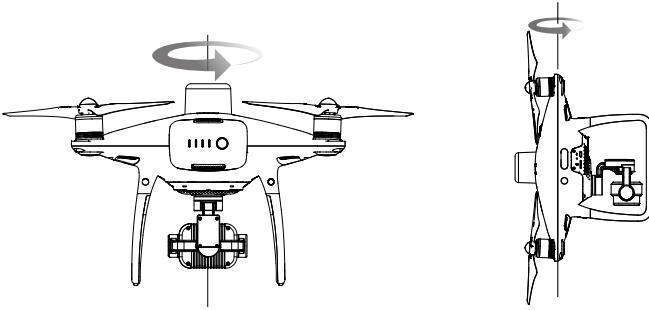

4. Re-calibrate the aircraft if the aircraft status indicators glows blinking red.



- If the Aircraft Status Indicator blinks red and yellow after the calibration procedure, move your aircraft to a different location and try again.



- DO NOT calibrate the compass near metal objects such as a metal bridge, cars, scaffolding.
- If the aircraft status indicators are blinking red and yellow alternately after placing the aircraft on the ground, the compass has detected magnetic interference. Change your location.

## Starting/Stopping the Motors

### Starting the Motors

A Combination Stick Command (CSC) is used to start the motors. Push both sticks to the bottom inner or outer corners to start the motors. Once the motors have started spinning, release both sticks simultaneously.

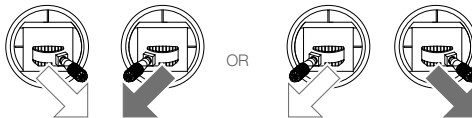

### Stopping the Motors

There are two methods to stop the motors.

Method 1: When the aircraft has landed, push the left stick down ①, then conduct the same CSC that was used to start the motors, as described below ②. Motors will stop immediately. Release both sticks once motors stop.

Method 2: When the aircraft has landed, push and hold the left stick down. The motors will stop after three seconds.

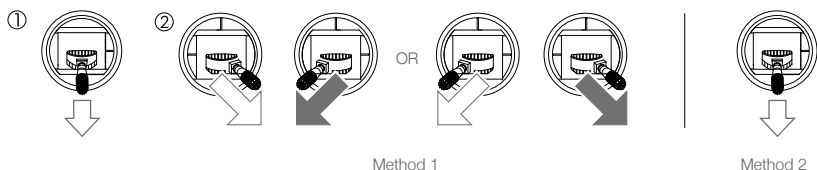

## Stopping Motors Mid-flight

Perform the CSC to stop the motors. It can be enabled in the app. Go to Camera View, tap ●●●, Aircraft Settings, ⚙️, then tap Advanced Settings to enable Stop Motors in Urgency. Only stop motors mid-flight in emergency situations when doing so can reduce the risk of damage or injury.

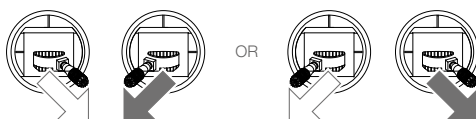

## Flight Test

### Takeoff/Landing Procedures

1. Place the aircraft in an open, flat area with the battery level indicators facing towards you.
2. Turn on the remote controller and then turn on the Intelligent Flight Battery.
3. Launch DJI GS Pro and enter Mission Page.
4. Wait until the Aircraft Status Indicators start to blink green slowly, which indicates that GNSS or RTK is in use. If using RTK, ensure that the RTK function is enabled and that the RTK/GNSS signal strength icon shows FIX. Then perform CSC to start motors.
5. Push the left stick up slowly to take off.
6. To land, hover over a level surface and gently pull down on the left stick to descend.
7. After landing, hold the left stick at its lowest position until the motors stop.
8. Turn off the Intelligent Flight Battery first, then the remote controller.



- When the Aircraft Status Indicators blink yellow rapidly during flight, the aircraft has entered Failsafe mode.
- A low battery level warning is indicated by the Aircraft Status Indicators blinking red slowly or rapidly during flight.
- Watch our video tutorials for more flight information.

## Video Suggestions and Tips

1. Go through the full pre-flight checklist before each flight.
2. Only shoot photos or record videos when flying in P-mode.
3. Always fly in good weather conditions and avoid flying in rain or heavy wind.
4. Choose the camera settings that suit your needs. Settings include ISO, exposure values, etc.
5. Perform flight tests to establish flight routes and preview scenes.
6. Push the control sticks gently to keep the aircraft's movement smooth and stable.



It is important to understand basic flight guidelines, for the safety of both you and those around you. Do not forget to read the disclaimer and safety guidelines.

---



# DJI Assistant 2 for Phantom

---

This section introduces the usage of the DJI Assistant 2 for Phantom software.

# DJI Assistant 2 for Phantom

Update firmware, copy flight records and calibrate the Vision System in the DJI Assistant 2 for Phantom software. For users that own DJI Agras aircraft, the DJI Assistant 2 for MG can also be used for the functions above.

## Installation and Launching

1. Download the software installation file from the P4 Multispectral download page:  
<https://www.dji.com/p4-multispectral/downloads>
2. Install the software.
3. Launch DJI Assistant 2 for Phantom.

## Using DJI Assistant 2 for Phantom

### Connecting the Aircraft

Connect the Micro USB port of the aircraft to your computer with a Micro USB cable. Then power on the aircraft.

---

 Be sure to remove the propellers before using DJI Assistant 2 for Phantom.

---

### Firmware Update

A DJI account is required for firmware updates. Login with your DJI account or register for one.

### Data Upload

Save the flight data recorded by the flight controller or the system logs to a local path or upload them.

### Flight Data

Click Open Data Viewer to view flight data. Data Viewer is used to view and analyze the flight data files of the aircraft for performance analysis and troubleshooting.

### Calibration

Calibrate the Vision System here when the app prompts for calibration.

### Connecting the Remote Controller

Connect the Micro USB port of the remote controller to your computer with a Micro USB cable. Then power on the remote controller.

### Firmware Update

A DJI account is required for firmware updates. Login with your DJI account or register for one.

- 
-  • DO NOT power off the remote controller during the update.
- DO NOT perform the firmware update while the aircraft is in the air. Only carry out the firmware update when the aircraft is on the ground.
  - The remote controller may become unlinked from the aircraft after the firmware update. Relink the remote controller and aircraft if necessary.
-

# Appendix

---

# Appendix

## Specifications

Aircraft	
Takeoff Weight	1487 g
Diagonal Distance (Propellers Excluded)	350 mm
Max Service Ceiling Above Sea Level	19685 ft (6000 m)
Max Ascent Speed	6 m/s (automatic flight); 5 m/s (manual control)
Max Descent Speed	3 m/s
Max Speed	31 mph (50 kph) (P-mode); 36 mph (58 kph) (A-mode)
Max Flight Time	Approx. 27 minutes
Operating Temperature	0° to 40° C (32° to 104° F)
Operating Frequency	2.4000 GHz to 2.4835 GHz (Europe, Japan, Korea) 5.725 GHz to 5.850 GHz (Other countries/regions) <sup>[1]</sup>
Transmission Power (EIRP)	2.4 GHz: < 20 dBm (CE / MIC / KCC) 5.8 GHz: < 26 dBm (FCC / SRRC / NCC)
Hover Accuracy Range	RTK enabled and functioning properly: Vertical: ±0.1 m; Horizontal: ±0.1 m RTK disabled: Vertical: ±0.1 m (with vision positioning); ±0.5 m (with GNSS positioning) Horizontal: ±0.3 m (with vision positioning); ±1.5 m (with GNSS positioning)
Image Position Compensation	The relative positions of the centers of the six cameras' CMOS and the phase center of the onboard D-RTK antenna have been calibrated and are recorded in the EXIF data of each image.
GNSS	
Single-Frequency High-Sensitivity GNSS	GPS + BeiDou + Galileo <sup>[2]</sup> (Asia); GPS + GLONASS + Galileo <sup>[2]</sup> (other regions)
Multi-Frequency Multi-System High-Precision RTK GNSS	Frequency Used GPS: L1/L2; GLONASS: L1/L2; BeiDou: B1/B2; Galileo <sup>[2]</sup> : E1/E5 First-Fixed Time: < 50 s Positioning Accuracy: Vertical 1.5 cm + 1 ppm (RMS); Horizontal 1 cm + 1 ppm (RMS). 1 ppm indicates error with a 1 mm increase over 1 km of movement. Velocity Accuracy: 0.03 m/s
Mapping Functions	
Ground Sample Distance (GSD)	(H/18.9) cm/pixel, H indicates the aircraft altitude relative to the area mapped (unit: m)

Rate of Data Collection	Max operating area of approx. 0.63 km <sup>2</sup> for a single flight at an altitude of 180 m, i.e., GSD is approx. 9.52 cm/pixel, with a forward overlap rate of 80% and a side overlap ratio of 60%, during a flight that drains the battery from 100% to 30%.
<b>Gimbal</b>	
Controllable Range	Pitch: -90° to +30°
<b>Vision System</b>	
Velocity Range	≤ 31 mph (50 kph) at 6.6 ft (2 m) above ground with adequate lighting
Altitude Range	0 - 33 ft (0 - 10 m)
Operating Range	0 - 33 ft (0 - 10 m)
Obstacle Sensory Range	2 - 98 ft (0.7 - 30 m)
Operating Environment	Surfaces with clear patterns and adequate lighting (> 15 lux)
<b>Infrared Sensing System</b>	
Obstacle Sensory Range	0.6 - 23 ft (0.2 - 7 m)
FOV	70°(Horizontal), ±10°(Vertical)
Measuring Frequency	10 Hz
Operating Environment	Surface with diffuse reflection material, and reflectivity > 8% (such as wall, trees, humans, etc.)
<b>Camera</b>	
Sensors	Six 1/2.9" CMOS, including one RGB sensor for visible light imaging and five monochrome sensors for multispectral imaging. Each Sensor: Effective pixels 2.08 MP (2.12 MP in total)
Filters	Blue (B): 450 nm ± 16 nm; Green (G): 560 nm ± 16 nm; Red (R): 650 nm ± 16 nm; Red edge (RE): 730 nm ± 16 nm; Near-infrared (NIR): 840 nm ± 26 nm
Lenses	FOV (Field of View): 62.7° Focal Length: 5.74 mm (35 mm format equivalent: 40 mm), autofocus set at ∞ Aperture: f/2.2
RGB Sensor ISO Range	200 - 800
Monochrome Sensor Gain	1 - 8x
Electronic Global Shutter	1/100 - 1/20000 s (visible light imaging); 1/100 - 1/10000 s (multispectral imaging)
Max Image Size	1600×1300 (4:3.25)
Photo Format	JPEG (visible light imaging or multispectral index map) + TIFF (multispectral imaging)
Supported File Systems	FAT32 (≤ 32 GB); exFAT (> 32 GB)
Supported SD Cards	microSD with a minimum write speed of 15 MB/s. Max Capacity: 128 GB. Class 10 or UHS-1 rating required
Operating Temperature	0° to 40° C (32° to 104° F)

<b>Remote Controller</b>	
Operating Frequency	2.4000 GHz to 2.4835 GHz (Europe, Japan, Korea) 5.725 GHz to 5.850 GHz (Other countries/regions) <sup>[1]</sup>
Transmission Power (EIRP)	2.4 GHz: < 20 dBm (CE / MIC / KCC) 5.8 GHz: < 26 dBm (FCC / SRRC / NCC)
Max Transmission Distance	FCC / NCC: 4.3 mi (7 km); CE / MIC / KCC / SRRC: 3.1 mi (5 km) (Unobstructed, free of interference)
Built-in Battery	6000 mAh LiPo 2S
Operating Current / Voltage	1.2 A @ 7.4 V
Mobile Device Holder	Tablets and smartphones
Operating Temperature	0° to 40° C (32° to 104° F)
<b>Intelligent Flight Battery (PH4-5870mAh-15.2V)</b>	
Capacity	5870 mAh
Voltage	15.2 V
Battery Type	LiPo 4S
Energy	89.2 Wh
Net Weight	468 g
Operating Temperature	-10° to 40° C (14° to 104° F)
Charging Temperature	5° to 40° C (41° to 104° F)
Max Charging Power	160 W
<b>Intelligent Flight Battery Charging Hub (P4CH)</b>	
Voltage	17.5 V
Operating Temperature	5° to 40° C (41° to 104° F)
<b>AC Power Adapter (PH4C160)</b>	
Voltage	17.4 V
Rated Power	160 W

[1] To comply with local laws and regulations, this frequency is not available in some countries or regions.

[2] Support for Galileo is coming soon.

DJI Support  
<http://www.dji.com/support>

This content is subject to change.

**Download the latest version from**  
**<https://www.dji.com/p4-multispectral>**

If you have any questions about this document, please contact  
DJI by sending a message to **[DocSupport@dji.com](mailto:DocSupport@dji.com)**.

DJI is a trademark of DJI.

Copyright © 2020 DJI All Rights Reserved.