



vLoc3 RTK-Pro User Handbook (English Edition)

Version 1.2

P/N: 4.04.000170



General Safety & Care Information

Who Can Use This Equipment

- This equipment must only be used by people suitably trained in the use of pipe and cable locators.

Work-site Safety

- Use your company's or other applicable safety codes and rules when using this equipment.
- Unless having the required authorization, license, and appropriate training, do not connect to any pipe, cable, or conductor.
- The equipment should not come in contact with corrosive or hazardous chemicals, gases or dust.
- **Do not** directly connect this equipment to cables or pipes with a potential difference to ground greater than 25V AC.

Equipment Safety

- **Do not** open the enclosures (housings) of either the transmitter or receiver.
- Place the ground stake firmly in the ground before connecting the cable from the transmitter.
- **Do not** hold any uninsulated portion of the connection leads & clips when the transmitter is switched on.

Batteries and Environmental Safety

Vivax-Metrotech products use four types of batteries:

- Alkaline batteries
- Ni-MH (Nickel-Metal Hydride) batteries – rechargeable
- Lithium-Ion batteries – rechargeable
- Lithium-Metal batteries – (small non-rechargeable button cells for "clock" applications)

1. Alkaline Batteries (Non-Rechargeable)

- When replacing the alkaline batteries – use only the size and type specified – **do not** mix battery types (rechargeable and alkaline).
- **Do not** mix partially discharged and fully charged cells in the same battery pack – **do not** mix old with new.
- **Never** attempt to charge alkaline batteries.

2. Nickel-Metal Hydride Batteries (Rechargeable)

- When using rechargeable batteries, use only the correct charging device supplied or specified by the manufacturer. The battery pack or the battery charger will contain circuitry to manage the charging process – other chargers (even if they have the same connector, polarity, voltage & current rating) will not have the same control circuitry and can cause damage to the product, overheating, and in extreme cases fire or harm to the individual.
- **Do not** assume that if the plug fits, it is the correct charger – a charger with the correct part number **must** be used – just because it is a Vivax-Metrotech charger and the plug fits it **does not** mean it is the correct charger.
- Before using for the first time, charge rechargeable batteries for six hours. If the rechargeable batteries do not last as long as anticipated at any time, discharge fully and then charge for six hours.
- Care should be taken when charging batteries – **Never** repeatedly recharge batteries (or turn the power off & on) without using the instrument. If used with an inverter in a vehicle – charge the product, unplug the charger, and **not** charge again until the rechargeable batteries have been used for at least ten minutes. Failure to do this could result in the overcharging of the battery, which will shorten the battery's life and could, in some circumstances, cause overheating or fire.
- If the product becomes hot during the charging process, **immediately** unplug the charger, and use the rechargeable batteries for at least ten minutes before recharging. If this happens, the next time the unit is charged, return it to Vivax-Metrotech for replacement.
- **Do not** charge batteries for prolonged periods without using the locator for at least ten minutes. Charging for a prolonged period could overcharge the battery, reduce battery life, and in extreme circumstances, cause damage to the locator and fire.

3. Lithium-Ion Batteries (Rechargeable)

- Lithium-Ion Batteries – some products use Lithium-Ion batteries – the requirements for marking and transportation are still developing. Please contact Vivax-Metrotech before shipping products containing Lithium-Ion batteries or Lithium-Ion battery packs on their own for any "special instructions."

4. Lithium-Metal Batteries (Non-Rechargeable)

- Commonly known as "button cells," these are small – non-rechargeable batteries used to power internal "clocks" within some units (similar to computers). Generally, they have a life of three to five years.
- Under no circumstances should any attempt be made to charge these batteries.
- Dispose of using your company's work practice/environmental standards, the prevailing laws, or recognized best practice. Always dispose of batteries responsibly.

5. General Rules regarding Disposal of Batteries

- **Never** disassemble a battery or battery pack.
- **Never** dispose of in a fire or water.
- Dispose of batteries following your company's work practice/environmental standards, the prevailing laws, or recognized best practice. Always dispose of batteries responsibly.

6. Transportation of Lithium-Ion and Lithium-Metal Batteries

- The Lithium-Ion and Lithium-Metal batteries used in Vivax-Metrotech products meet the required safety standards and include the designated protection circuitry.
- Recent regulation changes require that when batteries with Lithium-Ion and Lithium-Metal batteries are transported, the packaging must include specified warning labels.
- **Please contact Vivax-Metrotech Customer Service (USA 1-800-446-3392, International +1-408-734-1400 (USA Pacific Time Zone)) for more details.**
- Regulations have also changed regarding the shipping of spare battery packs (battery packs that are not inside a product). There are limitations on the package's weight, and the packaging must be marked with the appropriate warning labels.
- **Please contact Vivax-Metrotech Customer Service (USA 1-800-446-3392, International +1-408-734-1400 (USA Pacific Time Zone)) for more details.**
- Vivax-Metrotech vLoc Series 3 products using Lithium-Ion battery are classified as "not restricted." They can be shipped normally by road/rail/sea & air (passenger & freight aircraft) without restrictions.



IMPORTANT

Remember – Batteries contain dangerous chemicals – They can be affected by many things such as water ingress or heat – In some circumstances, they can explode. They also can cause electric shocks!

Care of Equipment

- Use equipment only as directed in this User Handbook.
- **Do not** immerse any part of this equipment in water.
- Store in a dry place.
- Keep equipment in the case provided when not in use.
- If left for a prolonged period – remove alkaline batteries.
- Keep the unit clean and free of dust and dirt.
- Protect against excessive heat.

Care when Interpreting the Information provided by the Locator

- Like all locators – this instrument is locating and providing depth and current readings based on electromagnetic signals that radiate from the buried cable or pipe. In most cases, these signals will enable the locator to pinpoint both position depth and current correctly.
- **Beware – in some cases, other factors will distort the electromagnetic fields radiating from cables or pipes being located, resulting in incorrect information.**
- Always locate responsibly and use information learned during your training to interpret the information provided by the locator.
- **Do not** provide information regarding cable or pipe depth to anyone unless authorized to do so by your company.
- **Remember** that depth measurements are to the center of the electromagnetic field or pipe – In the case of pipes, this may be significantly deeper than the top of the pipe.

American & Canadian Safety Notices

USA

- This transmitter and receiver comply with the general conditions of operation, according to part 15 of the FCC Rules.
 - CFR 47 Part 2
 - CFR 47 Part 15
- Changes or modifications not expressly approved by the manufacturer could void the user's authority to operate the products.

CANADA

- Equipment is for use by trained operators only and not for general household or consumer use.
- Operation is subject to the following two conditions: (1) this device may not cause interference, and (2) this device must accept any interference that may cause undesired operation of the device.

EUROPE

- Vivax-Metrotech confirms that the location system is compliant with the relevant provision of European directive 1999/5/EC.
 - EN 55011
 - EN 61000-4-2: A1 & A2
 - EN 61000-4-3
 - EN 61000-4-8: A1
 - ETSI EN 300 330-2
 - ETSI EN 301 489-1
 - ETSI EN 301 489-3

FCC & IC Statement

Please take attention that changes or modification not expressly approved by the party responsible for compliance could void the user's authority to operate the equipment. This device complies with Part 15 of the FCC Rules. Operation is subject to the following two conditions:

- (1) This device may not cause harmful interference, and
- (2) This device must accept any interference received, including interference that may cause undesired operation.

This device complies with Industry Canada licence-exempt RSS standard(s). Operation is subject to the following two conditions:

- (1) This device may not cause interference, and
- (2) This device must accept any interference, including interference that may cause undesired operation of the device.

Le présent appareil est conforme aux CNR d'Industrie Canada applicables aux appareils radioexemptés de licence. L'exploitation est autorisée aux deux conditions suivantes:

- (1) l'appareil ne doit pas produire de brouillage, et
- (2) l'utilisateur de l'appareil doit accepter tout brouillage radioélectrique subi, même si le brouillage est susceptible d'en compromettre le fonctionnement.

Under Industry Canada regulations, this radio transmitter may only operate using an antenna of a type and maximum (or lesser) gain approved for the transmitter by Industry Canada. To reduce potential radio interference to other users, the antenna type and its gain should be so chosen that the equivalent isotropically radiated power (e.i.r.p.) is not more than that necessary for successful communication.







Conformément à la réglementation d'Industrie Canada, le présent émetteur radio peut fonctionner avec une antenne d'un type et d'un gain maximal (ou inférieur) approuvé pour l'émetteur par Industrie Canada. Dans le but de réduire les risques de brouillage radioélectrique à l'intention des autres utilisateurs, il faut choisir le type d'antenne et son gain de sorte que la puissance isotrope rayonnée équivalente (p.i.r.e.) ne dépasse pas l'intensité nécessaire à l'établissement d'une communication satisfaisante.





RF exposure info

Occupational use only. This equipment complies with FCC/IC RSS-102 radiation exposure limits set forth for a controlled environment. SAR has been tested with a 10mm distance.

Usage professionnel uniquement. ce matériel est conforme aux limites de dose d'exposition aux rayonnements, FCC/CNR-102 énoncée dans autre environnement. Le SAR a été testé avec une distance de 10 mm.

Table of Content

1.	Service & Support	1
1.1	Serial Number and Software Revision Number.....	1
1.2	Worldwide Sales Offices and Service Centers	2
2.	vLoc3 RTK-Pro Receiver	3
2.1	vLoc3 RTK-Pro Receiver Overview.....	3
2.2	Charging the Receiver Batteries	4
2.3	vLoc3 RTK-Pro Receiver Keypad.....	5
2.4	The vLoc3 Series User Menu.....	5
2.4.1	Setup - Receiver	6
2.4.2	Setup - Operational	6
2.4.3	Setup - Feature	7
2.4.4	Setup – Informational	8
2.5	Self-Test	8
2.6	Warnings and Alerts	9
2.6.1	Warnings and Alerts Descriptions	9
2.6.2	DFT (Discrete Fourier Transform)	9
2.7	Setting up the vLoc3 RTK-Pro mapping functions.....	10
2.7.1	SIM Set-up	11
2.7.2	Set up the RTK connections using MyLocator3	12
2.7.3	Set up the RTK settings in the Locator.....	13
2.7.4	Set the VMap Cloud Settings	14
2.8	RTK-Pro Battery Consumption	16
2.9	vLoc3 RTK-Pro Locate Modes and Screens	16
2.9.1	The Classic Screen Status Bar	16
2.9.2	The Classic Screen	17
2.10	Classic Locating Modes (Response).....	17
2.10.1	Peak Response Mode 	17
2.10.2	Broad Peak Mode 	18
2.10.3	Null Mode 	18
2.10.4	Delta Null 	18
2.10.5	Peak with Arrows Response Mode 	18
2.10.6	Omni Peak Response Mode 	19
2.10.7	Information Pushbutton (Depth and Current)	19
2.11	Alternative Locate Screens	20
2.11.1	Vector Configuration Screen.....	20
2.11.2	The Transverse Graph Screen	21
2.11.3	The Plan View Screen	22
3.	Using the vLoc3 RTK-Pro	24
3.1	Passive Locating	24
3.1.1	Detecting Power Signals	24
3.1.2	Detecting Radio Signals.....	25
3.2	Active Locating:- Applying the Transmitter	26
3.2.1	Direct Connection.....	26
3.2.2	Transmitter Signal Clamp (for frequencies above 8kHz).....	27
3.2.3	Induction (for frequencies above 8kHz)	29

3.3	Locating Active Signals	30
3.4	Searching (sweeping) an Area in the Peak Mode	31
3.5	Searching (sweeping) an Area in the Omni Peak Mode.....	31
3.6	Tracing a Buried Line	31
3.7	Depth & Current Measurement	31
3.8	Distorted Fields	32
3.9	Sonde Location Mode	33
3.10	Walk Back Feature	35
3.10.1	VMMMap Web Portal	35
3.10.2	Performing an RTK-Pro Walk Back	37
3.11	Feature Logging	39
3.11.1	Requirements:	39
3.11.2	Setup and Import of Data Dictionary	39
3.11.3	Logging Features.....	40
3.11.4	Auto Log Feature.....	41
3.11.5	Feature Logs in VMMMap Cloud.....	42
4.	Data Logging.....	43
4.1	How to Create Data Logs	43
4.2	Pairing the receiver with dataloggers, mobile phones and other external devices.....	44
4.3	Transferring Data from the vLoc3 Receiver to a Computer.....	44
4.3.1	The MyLocator3 Desktop App.....	45
4.3.2	MyLocator3's Basic Operation	45
4.3.2.1	Updates Page	45
4.3.2.2	Application Update	46
4.3.2.3	Locator Firmware update	46
4.3.3	Toolbar.....	47
4.3.4	Feature tabs	47
4.3.5	Data Logging 	47
4.3.6	Splash Screen 	48
4.3.7	Frequencies Page 	50
4.3.8	Menu Settings 	50
4.3.9	Cloud, Internet and RTK Settings 	51
4.3.10	Advanced Features	51
4.3.10.1	Supervisor Lockouts.....	51
5.	The Loc3 Series Transmitters.....	52
5.1	Loc3 Series Transmitter Overview	52
5.2	The Transmitter Display.....	52
5.3	Pushbuttons	53
5.3.1	Transmitter Information Pushbuttons	53
5.3.2	Transmitter Connections Block	54
5.4	Transmitter Batteries – Li-ion and Alkaline	54
5.5	Charging the Transmitter Battery Tray	55
5.6	Removing and Installing the Battery Tray.....	56
5.7	Transmitter Modes.....	56
5.7.1	Direct Connection Mode.....	57
5.7.2	Clamp Mode.....	57
5.7.3	Induction Mode – 5-Watt and 10-Watt Transmitters Only.....	58
5.8	Transmitter Frequencies.....	58
5.8.1	Frequencies and Maximum Power Output.....	58
5.8.2	Most Used Frequencies (Frequency Selection) Feature.....	59

5.8.3	Multi-Frequency Mode for Direct Connection.....	60
5.9	Transmitter Link (TX-Link) 	61
6.	Accessories & Options.....	64
6.1	Transmitter Signal Clamps.....	64
6.2	A-Frame Fault Locator.....	64
6.3	vLoc3-MLA (Marker Locator Adapter).....	64
7.	Glossary.....	65

1. Service & Support

1.1 Serial Number and Software Revision Number

Always quote your receiver and transmitter model number, serial number, and software revision number when requesting product support. They can be found as follows: (for reference only).



1	Model & Serial Number
---	-----------------------



NOTE

Software Revision Number: On both receiver and transmitter, the software revision number is displayed on the LCD during the startup sequence if the default start screen is used. It can also be found in the “About” section of the user menu.



Receivers with the **SD** option installed will show this icon label on the blade where it meets the yellow upper housing.



Receivers with the **Tx-Link** option installed will show this icon label on the blade where it meets the yellow upper housing.
Transmitters with the **Tx-Link** option installed will show this icon label on the upper corner of the housing.

1.2 Worldwide Sales Offices and Service Centers

Worldwide Sales Offices and Service Centers	
<p>World Headquarters, United States of America Vivax-Metrotech Corporation 3251 Olcott Street, Santa Clara, CA 95054, USA T/Free: 1-800-446-3392 Tel: +1-408-734-3880 Fax: +1-408-734-1415 Website: www.vivax-metrotech.com Email: SalesUSA@vxmt.com</p>	<p>Central/South America and the Caribbean Ventas para América Latina 3251 Olcott Street, Santa Clara, CA 95054, USA T/Free: 1-800-446-3392 Tel: +1-408-734-3880 Fax: +1-408-743-5597 Website: www.vivax-metrotech.com Email: LatinSales@vxmt.com</p>
<p>Canada Vivax Canada Inc. 41 Courtland Ave Unit 8, Vaughan, ON L4K 3T3, Canada Tel: +1-289-846-3010 Fax: +1-905-752-0214 Website: www.vivax-metrotech.ca Email: SalesCA@vxmt.com</p>	<p>France Vivax-Metrotech SAS Technoparc - 1 allée du Moulin Berger, 69130 Ecully, France Tel: +33(0)4 72 53 03 03 Fax: +33(0)4 72 53 03 13 Website: www.vivax-metrotech.fr Email: SalesFR@vxmt.com</p>
<p>Germany Metrotech Vertriebs GmbH Am steinernen Kreuz 10a, 96110 Schesslitz, Germany Tel: +49 9542 77227-43 Website: www.vivax-metrotech.de Email: SalesEU@vxmt.com</p>	<p>United Kingdom Vivax-Metrotech Ltd. Unit 1, B/C Polden Business Centre, Bristol Road, Bridgwater, Somerset, TA6 4WA, UK Tel: +44(0)1793 822679 Website: www.vivax-metrotech.co.uk Email: SalesUK@vxmt.com</p>
<p>China Vivax-Metrotech (Shanghai) Ltd. Building 10, Lane 1158 Zhongxin Rd., Songjiang District, Shanghai, China, 201615 Tel: +86-21-5109-9980 Website: www.vivax-metrotech.com Email: SalesCN@vxmt.com.cn</p>	

2. vLoc3 RTK-Pro Receiver

2.1 vLoc3 RTK-Pro Receiver Overview

The vLoc3 RTK-Pro is a Precision Location System designed to meet utility companies and their contractors' needs. The following describes the features and use of the receiver.

This user manual covers the **vLoc3 RTK-Pro** receiver. In this manual, this receiver may be referred to as vLoc3 series receiver, receiver or locator.

The vLoc3 Series Receivers are precision locators designed to meet the needs of utility companies and their contractors. The following describes the features and use of the RTK-Pro receiver.

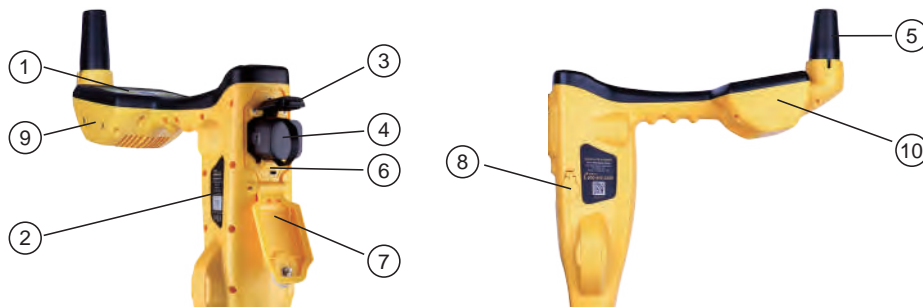

1	Pushbutton keypad display	6	Mini-USB port for data transfer and software updates
2	Model & serial number label	7	Battery compartment cover
3	Battery retaining cover	8	Accessory socket and charging point
4	AA Alkaline or Li-ion Battery Pack	9	Sim card
5	GNSS antenna housing	10	Internal Cellular Antenna

2.2 Charging the Receiver Batteries

The RTK-Pro can be used with either alkaline batteries or an interchangeable rechargeable battery pack.



The central illuminated section within the battery icon indicates the amount of charge remaining.

- Blue center indicates alkaline batteries.
- Green center indicates rechargeable batteries.
- When batteries are low, the remaining charge section becomes red and will flash.
- Just before shutdown, the following symbol will be shown:



Rechargeable batteries are supplied with a mains charger. This charger is specific to the batteries used. Avoid using other manufacturers' chargers as these may damage the battery pack and result in overheating the battery pack.

To charge the rechargeable batteries, first make sure the pack is inserted in the receiver battery compartment as charging is done with the battery inside the receiver.



Connect the charger to the charging/accessory socket of the receiver. Connect the charger to the mains and switch it on. The LED indicator on the charger will illuminate red until the batteries are fully charged, at which time the LED will change to green.



WARNING

Rechargeable batteries are supplied with a main or 12V DC charger. These are specific to the batteries. Only use the charger that is appropriate for the batteries in the product. If in doubt, call the Vivax-Metrotech customer service department at +1(800) 446-3392. Failure to use the appropriate charger could damage the battery pack, locator and, in extreme cases, cause a fire.

Avoid charging the unit in extreme temperature conditions. (i.e., below 0°C and above 45°C)

Although Vivax-Metrotech batteries include all the required safety-related features, immediately discontinue the charger and battery pack's use if the battery pack becomes excessively warm. Return both to where they were purchased for investigation.

Always ensure batteries have at least a partial charge if storing for long periods without use.

Dispose of all batteries following your company procedures and or Federal/State and local regulations.

Never dismantle batteries, put them in a fire, or get wet.

2.3 vLoc3 RTK-Pro Receiver Keypad

The grey color keys (3, 5, and 6) serve dual functions. You may have to Short Press by momentarily pressing the key or Long Press by pressing and holding the key until the desired function is shown.

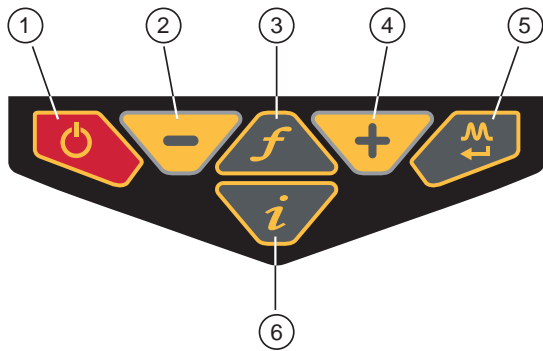

vLoc3 Series Keypad

1	On/Off
2	Reduce sensitivity. (Also scroll up when in User Menu)
3	Select frequency Long press = show the pre-selected frequency table
4	Increase sensitivity. (Also scroll down when in User Menu)
5	Enter Key Short press = change antenna response when in classic screen Long press = change the locate perspective
6	Information and Depth key Short press = enter the information and logging screen Long press = enter the User Menu

2.4 The vLoc3 Series User Menu

The user-configurable vLoc3 series receivers can be customized to suit the user’s preferences. The receivers have several features that can be switched on and off through the user menu.

This section covering the user menu is split into four subsections;

Setup – Covering the settings that are usually chosen and not often changed. Most of these settings apply to the locator’s physical attributes such as language, sound, and measure units.

Operational – Covers the locate screens and locate perspective.

Features – Are optional modes and physical add-ons such as Bluetooth, Marker Locator Adapter, and other options that may have been ordered.

Informational – Covers the receiver’s configuration, firmware version, and regulatory information.

It is recommended that the **Setup section** be done first. It will be easier to finish the receiver’s setup if it is done in the native language.

To enter the user menu, press and hold the “i”  key, release the key when in the menu.

Note that where you see this symbol , pressing the enter button gives access to the sub-menu associated with this button.

To exit the menu or sub-menu, press the “i”  button.

Where the  icon is not shown, the enter button is used to scroll through the options of that feature.

Use the “+” and “-” buttons to scroll up and down through the menu.

Switch on the unit by pressing and holding the On/Off key until the start-up screen appears. The start-up screen can be configured to the user’s preference and is described later in the manual. Otherwise, the start-up screen will default to the one below:



Default start screen

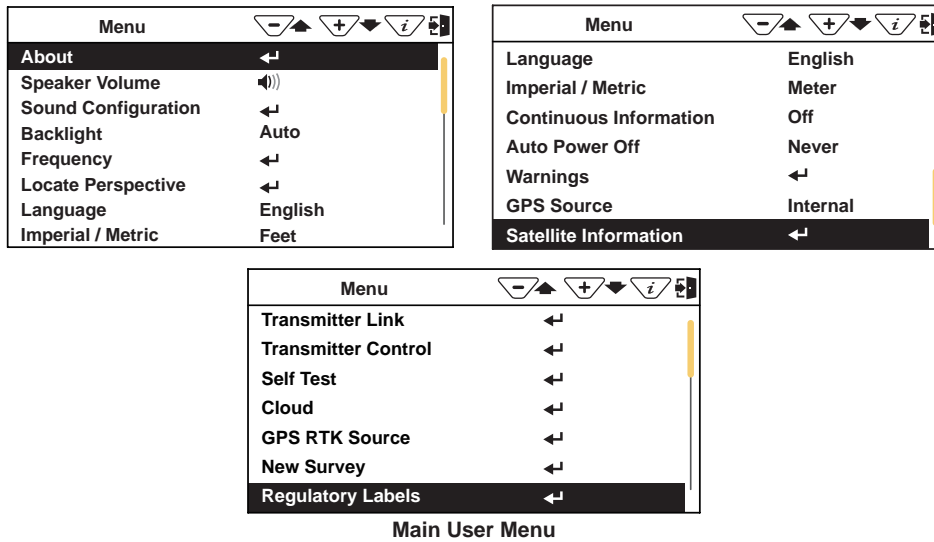

This manual will show three screens, but in the receiver it will be one continuous scrolling screen. Where you see this **Enter** button symbol  pressing the Enter button will access any associated sub-menus. While in a sub-menu use the “+” and “-” buttons to scroll through the menu.

To exit the menu or sub-menu, press the “f” button.

2.4.1 Setup - Receiver

Language – The receiver can be programmed in different languages. Repeatedly pressing the Enter key cycles through the list of available languages.

Speaker Volume – Repeatedly pressing the Enter key raises the speaker volume by three levels and then turns off the volume. When off  is displayed.

Backlight – Press the Enter key to change the backlight intensity to Low, Medium, High, or Auto. The use of the “Auto” selection is recommended because the receiver has a built-in light sensor that automatically adjusts the backlight intensity to the surrounding lighting conditions. Auto-selection may improve battery life performance.

Sound Configuration - Changes the sound configuration of the locate modes. Use the Enter key to select **AM** or **FM**.

- **When in active locate modes:**
 - Frequency Modulated (**FM**) Sound pitch changes with signal strength
 - Amplitude Modulated (**AM**) Sound volume changes with signal strength
- **When in passive locate modes:**
 - Radio mode: **FM** or **Real** (Sound derived directly from the received signal)
 - Power mode: **FM** or **Real**

Imperial/Metric – Use the Enter key to select Imperial or Metric measurements for the depth readings.

Continuous Info – The locate screens can display a continuous reading of either depth, current, both, or can be switched off. Use the Enter key to select your preference.

Auto Power Off – The unit can be set to switch off after a set time. Options are 5-minutes, 10-minutes, or Never. Note that when the accessory A-frame is connected, the timer defaults to “Never.”

2.4.2 Setup - Operational

Frequency - Press the Enter key to enter the Frequency sub-menu. Scroll up and down the table of available frequencies using the “+” and “-” keys.



TIP

Simplify the operation of the receiver by selecting only the frequencies applicable to your applications. To do this use the enter key to check the boxes on the right. Frequencies not checked will not appear on the locate screen.

Frequency	
8.01kHz	<input type="checkbox"/>
8.19kHz	<input type="checkbox"/>
8KFF	<input checked="" type="checkbox"/> A
8.44kHz	<input type="checkbox"/>
9.50kHz	<input type="checkbox"/>
9.80kHz	<input type="checkbox"/>
9.82kHz	<input checked="" type="checkbox"/>
10.0kHz	<input type="checkbox"/>



NOTE

Certain frequencies have an A-frame icon next to them. This icon indicates that these frequencies are selected to be used with the fault find A-frame.

Classic Locate – This option is only shown if the menu is entered from the Classic Screen. Use the enter key to reveal the list of options relating to the Classic Locate mode. Options are:

Classic Locate	
Peak	<input checked="" type="checkbox"/>
Peak With Arrows	<input checked="" type="checkbox"/>
Null	<input checked="" type="checkbox"/>
Broad	<input checked="" type="checkbox"/>
Delta Null	<input type="checkbox"/>
Omni Directional Peak	<input checked="" type="checkbox"/>
Omni Directional Broad	<input checked="" type="checkbox"/>

Locate Perspective – Enter this menu to select the graphical format that the locate data will be displayed. These displays are described further in the manual. The options are:

Locate Perspective	
Classic Locate	<input checked="" type="checkbox"/>
Vector Locate	<input checked="" type="checkbox"/>
Transverse Graph	<input checked="" type="checkbox"/>
Plan View	<input checked="" type="checkbox"/>
Sonde	<input checked="" type="checkbox"/>

GPS Source - Press the “Enter” key to select either Internal or Bluetooth. For the vLoc3 RTK-Pro, this is typically set to internal.

2.4.3 Setup - Feature

Warnings – Warnings relating to - Shallow cable, Overload, Overhead cable, and Signal Overload. Scroll down to the relevant warning and use the return button to select or de-select.

Bluetooth Pairing (if installed) – This option allows the receiver to link with external devices such as data loggers and GPS devices with Bluetooth capability. Press the enter button to enter the Bluetooth pairing routine.

Bluetooth Auto Connect – When this option is enabled, the receiver will automatically connect with any previously paired Bluetooth device.

Transmitter Link – The Loc3 series transmitters can be remotely operated from the receiver. This option requires the Transmitter (radio) Link to be installed in both the vLoc3 series receiver and the Loc3 series transmitter. Tx-Link is a factory fit option that must be purchased at the time of ordering. Currently, the Tx-Link feature is **only available in the Loc3 series 5-watt and 10-watt** transmitters.

Transmitter Control – This feature is used to control a transmitter with the Radio Link activated remotely. For more information, see the section “Remote Operation of the transmitter.”

DFT – Discrete Fourier Transform is a tool to help choose a frequency to apply to the target conductor. The DFT feature will aid the user with nearby interference that may affect the locate quality.

Cloud – This menu item ties the VMMMap Cloud-based app to the RTK-Pro unit. Use this menu item to check the Cloud connection status. To use the Vivax-Metrotech Cloud-based VMMMap app setup an account and register each locator that will use the app.

GPS RTK Source – Enter this option to check RTK connectivity and to select the RTK source. For more information check the section on Setting up RTK Connectivity.

New Survey – Navigating into this menu and selecting a survey type always causes a new survey to be initiated in the SD Card Data Logger. This will happen even if it is the same type as the previous log record. Different Survey types can be selected, as shown.

Electric
Gas
Communications
Potable Water
Reclaimed Water
Sewer
Temporary Survey
Proposed Excavation
Oil

2.4.4 Setup – Informational

About – This section holds the data about the locator, such as software revision, calibration data, etc.

Regulatory Labels – This section shows the required FCC ID and IC information. To access this information do the following:

1. Press and hold the Information pushbutton.
2. Use the – and + pushbuttons to highlight “Regulatory Labels.”
3. Press the Enter button when About is highlighted.

Self-Test – The vLoc3 series receivers have a self-test feature that confirms the equipment is fit for use and that the calibration has not drifted from its expected settings.

Satellite Information – Enter this menu item to show all current satellite information.

2.5 Self-Test

The self-test feature must be run in an area free from interference, such as overhead fluorescent lighting, large transformers, etc. Also, check that any nearby transmitters or sondes are switched off.

Select “Self-Test” from the user menu and press the “Return” button. Keep the receiver stationary while the test is running. After a short while, the test will complete, and the unit will report Passed or Failed.

	Self Test: PASSED					Self Test: FAILED					
	110.3	✓	✓	✓		✓	109.6	X	X	✓	✓
	110.3	✓	✓	✓		✓	109.9	X	X	✓	✓
	64.1	✓	✓	✓		✓	64.3	X	X	✓	✓
	110.3	✓	✓	✓		✓	109.7	X	X	✓	✓
	110.3	✓	✓	✓		✓	109.9	X	X	✓	✓
	64.1	✓	✓	✓		✓	64.5	X	X	✓	✓

Examples of the self-test results

If the receiver fails the test, try again in an area with less interference. If it continues to fail, return the unit to Vivax-Metrotech or one of its approved repair centers for investigation.

2.6 Warnings and Alerts

Warning symbols are accompanied by an audible sound and vibration in the handle unless otherwise configured in the MyLocator3 desktop app. Warnings can also be switched off in the setup menu.

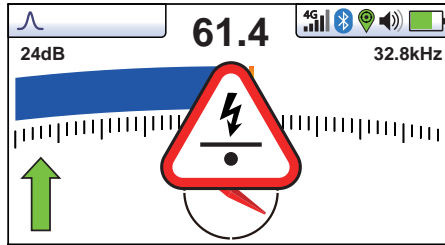

2.6.1 Warnings and Alerts Descriptions

ALERT	Alert Description
	Signal Overload - is usually caused by operating close to power transformers or being close to a transmitter in Induction mode. Moving away from the interfering signal will cure the problem.
	Shallow Cable - alerts indicate that the locator has detected a possibly less than 15cm (5.9-inch) deep cable. Proceed with caution.
	Swing Alert - indicates that the operator is swinging the locator excessively, resulting in misleading information. When sweeping the locator across the direction of the line, try to keep it vertical; this will improve its accuracy.
	Overhead Cable - alerts indicate that the source of the signal is mainly radiating from above. This alert is usually caused by the signal traveling along overhead cables.

2.6.2 DFT (Discrete Fourier Transform)

DFT is a tool to assist in choosing a frequency to apply to the target conductor. The DFT feature will aid the user with nearby interference that may affect the locate quality.



***Note the DFT feature should not solely be used to determine which frequency to apply. ALWAYS follow the appropriate safety requirements mandated by safety legislation, safety practice, or your company's safety procedures when applying a locate frequency to a conductor.**

1. To perform a DFT assessment, verify any nearby transmitters are powered off to avoid additional signal frequency disturbance.
2. Select your preferred frequencies from the frequency menu. These selected frequencies will be assessed in the next few steps.

Frequency	
128Hz	<input type="checkbox"/>
480Hz	<input type="checkbox"/>
491Hz	<input checked="" type="checkbox"/>
512Hz	<input checked="" type="checkbox"/>
577Hz	<input type="checkbox"/>
815Hz	<input type="checkbox"/>
982Hz	<input type="checkbox"/>
1.02kHz	<input type="checkbox"/>

3. Navigate to the main menu and scroll until you see DFT. Select DFT by pressing the enter key.
4. Once the option is selected, the receiver will automatically assess the user's preselected frequencies.

2 vLoc3 RTK-Pro Receiver

- The receiver will scan all available frequencies and display a progress bar, and the list of frequencies assessed will be displayed. The frequency under test is shown on the top line.



- A numerical value ranging from 0dB to 140dB will be presented next to the frequency list, with 140dB being the least possible interference detected and 0db with the largest amount of possible interference.
- The results are ranked from the least interference possible at the top to the largest amount of most possible interference at the bottom.
- In this case, the higher the dB number (80dB), the less interference has been detected by the receiver.

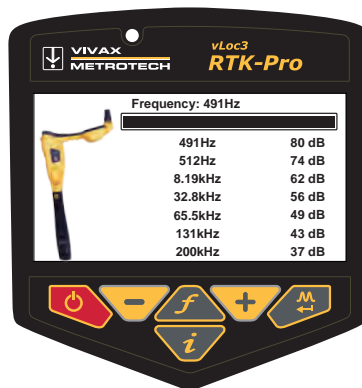

* Note - although frequency results appear to have less interference, it still does not make it the best choice to locate certain utilities. These include but are not limited to a conductor, current output, resistance, and signal bleed over adjacent utilities.

2.7 Setting up the vLoc3 RTK-Pro mapping functions

Introduction

This section describes the set-up and operation of the vLoc3 RTK-Pro in terms of the GNSS mapping capabilities.

The equipment is designed to provide cm accuracy. However, on its own, GNSS is not capable of providing the cm accuracy required for many survey applications. GNSS needs to be fine-tuned using stationary base stations that provide correction figures for all measurements. The real-time Kinematic (RTK) corrections are supplied from a central server (Trip Caster) via the cellular phone network and the Cloud.

2 vLoc3 RTK-Pro Receiver

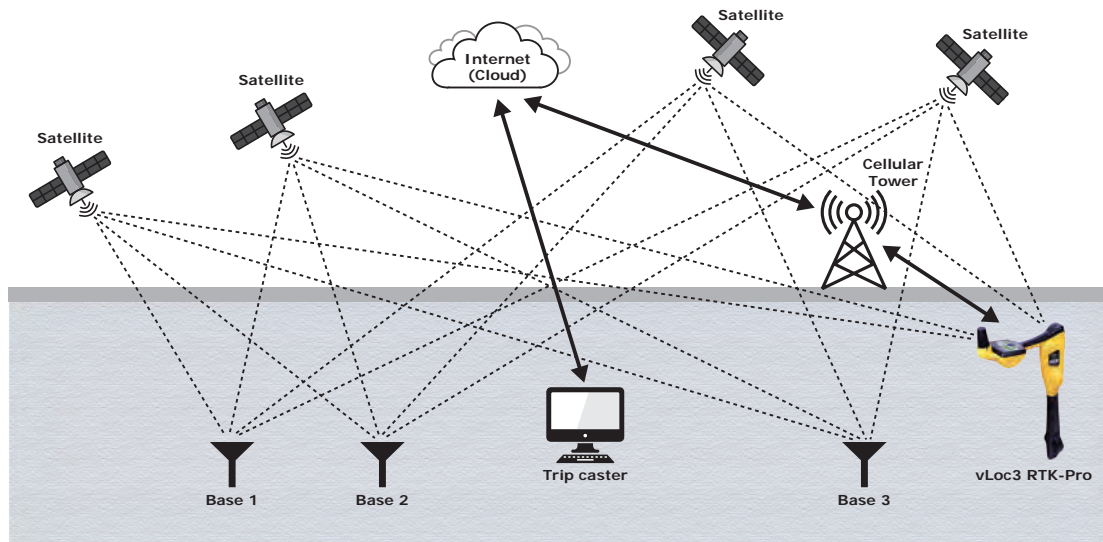

This set-up procedure assumes the operator has a suitable data-enabled SIM card registered with a cellular network provider and that the operator has registered with an RTK provider. It is also assumed that the operator has the latest version of MyLocator3 installed on a computer. (see the section on MyLocator3).

Three areas of set up are required before the cm accuracy GNSS can be used:

1. SIM set-up
2. RTK connections with MyLocator3
3. Cloud (VMMAP based data logging)

2.7.1 SIM Set-up

Data is received and transmitted from the vLoc3 via a cellular network of your choice.

Needed: nano-size data-enabled SIM card

Tools needed: Small cross blade screwdriver

1. Remove the expansion slot cover by unscrewing the two retaining screws.



The SIM card slot is positioned between two micro USB sockets. The USB sockets are used in manufacturing only so they should be ignored.

2. Insert the nano-sized SIM card connection pads facing upwards towards the display. Make sure the SIM card is pushed fully into place.





To remove the nano-SIM card, push the SIM in to unlatch it before it is released.

2.7.2 Set up the RTK connections using MyLocator3

Download and install the MyLocator3 desktop app. The app can be downloaded from the Vivax-Metrotech website under Products > Apps.

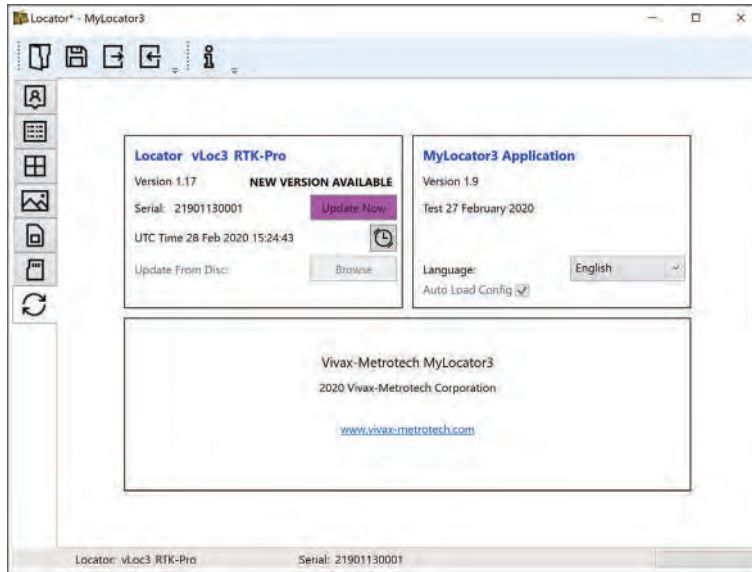
1. Connect the locator to the computer running the MyLocator3 app with the provided mini-USB cable.
2. Launch the MyLocator3 app, and a screen like the below will appear. Note the purple Update Now box will appear when an update is available.



3. Click on the  icon, which allows you to set the cloud settings as shown below.

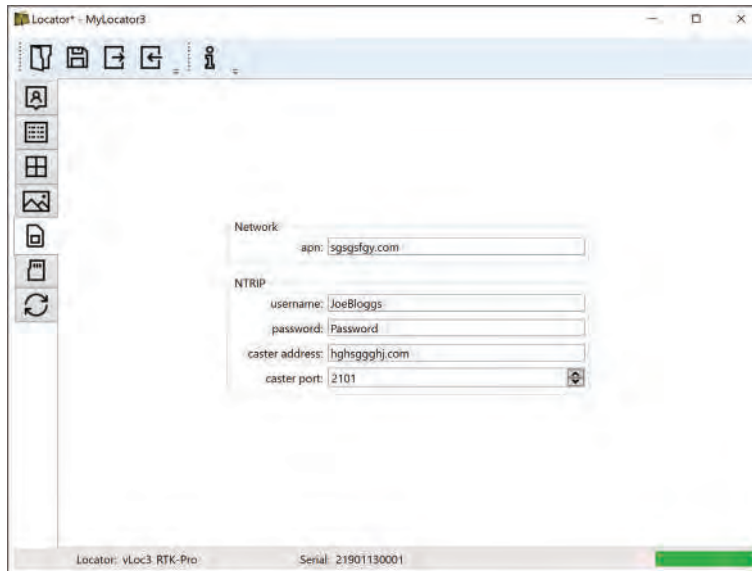

4. **Network "apn:"** should be adjusted to the Access Point Name for your chosen Mobile network – be sure not to add any spaces before or after the APN. If you do not have the APN, it should be possible to do a quick web search on “APN settings for a mobile network.”
5. **NTRIP** settings should match your preferred NTRIP caster settings. If you have subscribed to an RTK provider, they will give you your Caster address, caster port, Username, and password.
6. **Click on the**  **icon on the toolbar.** This sends the settings to the locator.

2.7.3 Set up the RTK settings in the Locator

It should now be possible to start using the locator, but first, a few locator settings need to be set.

1. Switch on the locator and enter the user settings by using a long press of the info key.
2. Scroll to the "About" option and press the return key. A screen similar to this will appear:



There may be a message "Cellular Module searching" shown for a few seconds. This is normal, as the module takes a few seconds to boot up. The two critical items in the about screen are:

- Cellular SIM **O2-UK LTE** Ready.
- Cellular Network (the tick shows a data connection is made, the LTE indicates a 4G LTE data connection is made). This confirms the SIM card is detected and active. Instead of showing O2 etc., it will show your cellular provider.

If the Cellular module is active, this screen will be made available in the user set up menu. Initially, it will show "RTK source," "None," and "RTCM status," "No Network."

Once a cellular network data connection has been made, it will show "RTCM status" "Waiting."

With the "Get RTK sources" highlighted, press "Enter" to ask the locator RTK to request the list of available RTK correction sources from the configured NTRIP caster.

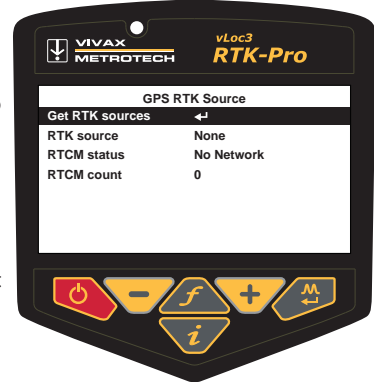

Scroll to the source you wish to use and press the enter key to select.

"RTCM status" will show "Waiting," then

"Connecting," then

"Requesting RTCM," then

"Receiving RTCM" as the locator receives RTCM from the NTRIP caster.

In this case, the "RTK source" shows the selected RTK source "RTK_MSM5."



2 vLoc3 RTK-Pro Receiver

Every 30 seconds the “RTCM status” will show “Sending GGA” as the vLoc3-RTK sends its GPS position to the NTRIP caster in an NMEA0183 GGA message if applicable

“RTCM count” shows an incrementing count of RTCM packets successfully received from the NTRIP caster

“RTK, ref. latitude/longitude” shows the GPS position of the RTK base station received from the NTRIP caster

“RTK, ref. distance” shows the distance between the vLoc3-RTK GPS position and the RTK base station GPS position (the larger this is, the greater GPS positional errors will be)

“RTK, ref. age” shows the age of the last RTK base station position received from the NTRIP caster. This should be updated every 10 seconds with a good data connection.

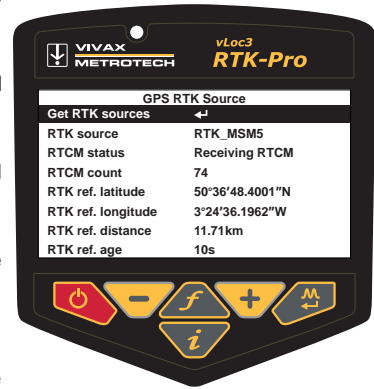

2.7.4 Set the VMMAP Cloud Settings

To use the VMMAP data logging facility, an account needs to be set up and each locator needs to be registered with the Vivax-Metrotech VMMAP mapping app. This manual assumes the locator is registered and the operator has an active account. Contact Vivax-Metrotech Corp for further information.

When registered, the locator will send updates to VMMAP whenever the user logs data, providing a cellular data connection.

You can check the data connectivity on the status bar.

If there is only signal strength bars without any letters, there is no data connection, i.e.:



Check the data log's status by entering the locator menu using a long press on the Information key and selecting **Cloud**.

Providing there is cellular data connectivity, the screen to the right should be available from the menu.

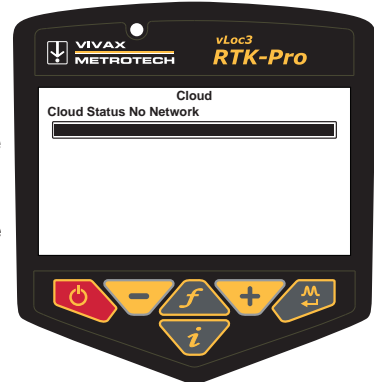

This screen becomes available from the main menu once the cellular module has been found. Initially, it will show “Cloud status,” “No Network.”

Once a cellular network data connection has been made, it will show “Cloud status” “Waiting.”

The progress bar shows the progress in sending vLoc3 logs on the SD card to the VXMT VMMP Cloud; in this case, it is 100% complete.

Any HTTP error codes reported by the VXMT VMMAP Cloud server will be displayed on a line under the progress bar.

The five lines starting “>” at the bottom of the screen show the AT commands. These are used to aid debugging and should be ignored.



2 vLoc3 RTK-Pro Receiver

When there are logs to send to the Cloud, the “Cloud Status” will show:

“Connecting,”

“Requesting Region Server,”

“Region Server Received”

The RTK-Pro uses its serial number to understand which regional VXMT VMMAP Cloud server it should connect to.



“Cloud Status” will then show:

“Connecting,”

“Requesting Authentication,”

“Authenticated”

As the vLoc3-RTK seeks authentication from the VXMT VMMAP Cloud server.



“Cloud Status” will then show:

“Connecting,”

“Requesting Survey ID,”

“Survey ID Received”

as the vLoc3-RTK requests the survey identifier from the VXMT VMMAP Cloud server.



“Cloud Status” will then show:

“Connecting,”

“Sending Log,”

“Log sent, OK.”

As the vLoc3-RTK sends the logs using the received authentication and survey ID to the VXMT VMMAP Cloud server.

The progress bar will fill as logs are sent to the Cloud.

Subsequent logs generated in the same survey will be sent to the Cloud as above without requiring the region, request authentication, or request a survey ID.

If a new survey is started and new logs are taken, a new survey ID will be requested before the new survey logs are sent to the Cloud.

2.8 RTK-Pro Battery Consumption

The vLoc3-RTK has considerably more electrical circuitry than a standard vLoc3 receiver, so the battery's power drain is considerably more.



Assure that you have a full day's charge in the battery by remembering to put the unit on charge the night before undertaking a full day's work.

Alternatively, a spare receiver battery can be purchased.

2.9 vLoc3 RTK-Pro Locate Modes and Screens

Note - The vLoc3 series user interface is under continual development. The screenshots described here may differ slightly from your screens.

The vLoc3 series receivers give the user a choice of locating screens.

The choice of the screen depends on the application and user preference. These screens are:

- **Classic Locate**
- **Plan View Locate**
- **Sonde Location**
- **Vector Locate**
- **Transverse Locate**

First, we will explain the functions of the "Classic Screen," as familiarity with this screen will help understand others' functions.

2.9.1 The Classic Screen Status Bar

All vLoc3 series screens have a status bar at the top, indicating various locator settings.

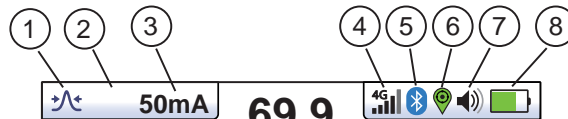







The vLoc3 Series Status Bar





1	Antenna configuration (meter response) described later in the manual	5	Bluetooth status (If Transmitter link is fitted this icon  will replace the blue tooth icon as they are mutually exclusive)
2	Other options	6	GPS status (see below for further explanation)
3	Signal Current/Depth to the target line. (can also be set to display signal current on the line or both)	7	Speaker volume setting
4	Cellular status (See below for further explanation)	8	Battery type and remaining charge

The Status Bar contains information relating to Cellular and GPS (GNSS) connectivity as below:

Cellular status:

- No cellular module or no signal bars 
- 1-5 bars of cellular signal, no data 
- GPRS (2G) data connection 
- EDGE (2.5G) data connection 
- UMTS (3G) data connection 
- HSPA (3.5G) data connection 
- LTE (4G) data connection 

GPS status:

- No GPS module 
- GPS module no data 
- Non-RTK GPS data 
- RTK float GPS data 
- RTK fix GPS data 

2.9.2 The Classic Screen

The Classic Screen has all the functions normally seen on a classic cable locator. The main functions being:

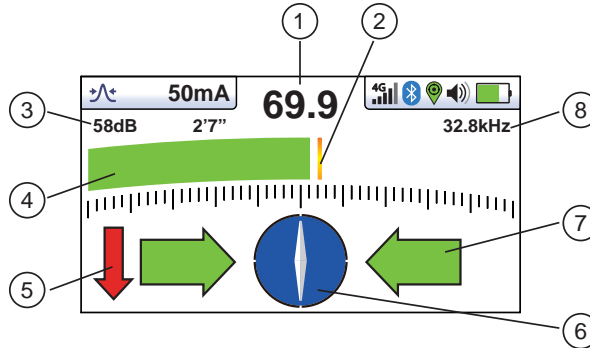

1	Percentage of signal strength (mirrors (4) the bar graph)	5	Signal Direction forward/back arrows (only active with Signal Direction frequencies)
2	Peak level indicator	6	360° Compass line direction indicator (turns blue when aligned with the target line)
3	Gain setting	7	Left/Right direction to target line indicators (when in applicable locate mode)
4	The signal strength bar graph will change color with the level of signal distortion: Green: Low distortion electromagnetic field Blue: Minor distortion in the electromagnetic field Red: Excessive distortion electromagnetic field	8	Frequency selection (flashing frequency indicates frequency selection is not valid for this screen. Choose another frequency)



TIP
When in a locate screen, pressing and holding the “f” key will bring up the frequency table.

Use the “+” and “-” keys to navigate quickly to the desired frequency. Press the “i” key to select a highlighted choice and return to the locate screen.

Radio
SD-EUR
8kHz
8KFF
33kHz
83kHz
200kHz

2.10 Classic Locating Modes (Response)

The vLoc3 RTK-Pro receiver has an array of six antennas, and these can be toggled through different configurations (modes) to provide different responses to the signals radiating from buried utilities. The modes are:

2.10.1 Peak Response Mode

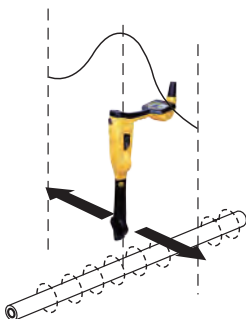

Two horizontal antennas provide a “Peak” or maximum signal response over the buried line.

This is an accurate locating method as both horizontal antennas are used to provide a clearly identifiable “Peak.” It is also less prone to the effects of signal distortion.

The Peak Level Indicator on the bar graph indicates the point of the largest signal detected, allowing the user to return to this point quickly.

The compass (line direction indicator) aligns itself parallel to the cable (available in Active modes).

2.10.2 Broad Peak Mode

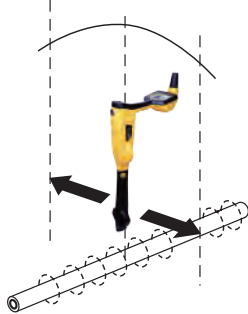

A single horizontal antenna provides a "Peak" or maximum signal response over the buried line.

The result is a less defined peak than the twin horizontal antenna "Peak" mode. This mode is useful in deep lines because using a single antenna can boost the received signal.

The compass (line direction indicator) aligns itself parallel to the cable (available in Active modes).

2.10.3 Null Mode

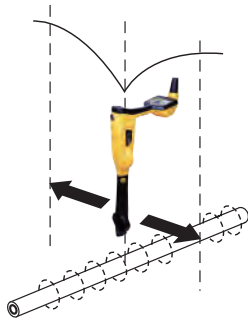

The vertical Null antennas receive a minimum or "Null" response over the buried line.

The null mode works well in uncongested areas but is more prone to inaccuracies due to field distortion. This effect can be utilized to detect distorted fields by comparing the "Null Mode" position with the position of the "Peak Mode." If the two positions do not coincide, this indicates possible distortion. The greater the difference, the greater the distortion.

Left/right arrows indicate the direction to move the receiver to locate the buried line's position while in the "Null" mode.

The compass (line direction indicator) aligns itself parallel to the direction of the cable (available in Active modes)

2.10.4 Delta Null

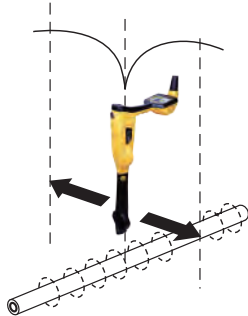

The Delta Null has the advantage that it provides a sharper response than the "null" mode and is less affected by distorted fields. All other functions are the same as the "Null" mode.

Delta mode uses dual null antennas to minimize the offset effects of field distortion. This mode tends to be more precise than the Null mode.

2.10.5 Peak with Arrows Response Mode



The Peak with Arrows mode operates in the same way as the peak mode. It gives the largest meter deflection when directly over the line. However, the left/right indication arrows are also displayed. The arrows indicate the direction to move the receiver to locate the position of the buried line.

Note:

If the arrows indicated a different position for the cable than the peak bar graph position, this indicates the possibility of a distorted field. Check by taking a depth reading on the ground and then lift the cable locator to a known distance such as 1m (3ft). If the depth does not increase by this amount, it confirms a distorted field, and the data should be treated with caution.

2.10.6 Omni Peak Response Mode

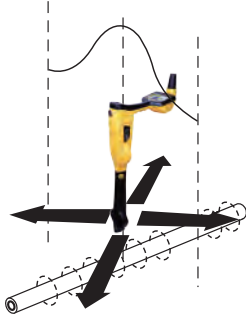

The two double-ended arrows around an icon mean that the line is detectable regardless of locator blade orientation.

It is very useful for quickly checking an area for buried lines using a grid search as one sweep will catch all locatable lines. In the classic screen, the Omni feature is available in the “Peak” and “Broad peak” modes.

2.10.7 Information Pushbutton (Depth and Current)

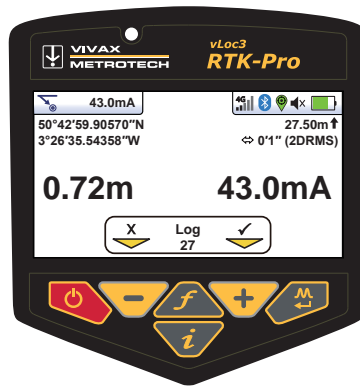

When in a Locate screen, a quick press of the “i” (information) pushbutton will display the depth and signal current.

The display shown above shows Longitude/Latitude positional information. To the top right is the height above sea level. This is only displayed when the equipment is paired with a valid GPS and a valid signal is received. Also, note that the 2DRMS is shown; this is the expected GNSS/RTK accuracy.

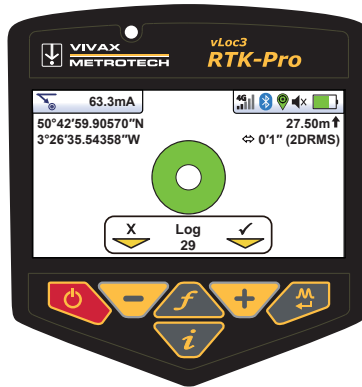

If a valid GNSS/RTK fix is available, an additional screen will be shown with a spirit level. The function of this is described in the “Datalogging” section.

It is also possible to save the data to the internal memory. This is explained in detail in the “Datalogging” section.



IMPORTANT

When locating a cable or pipe (“Line”) – depth and current measurements should only be taken with the bottom of the receiver standing on the ground and directly in line with the target line. Unless the  Omni direction mode is selected in which case orientation is not important.

The accuracy of depth and current readings depends on the quality of the radiated signal being located. If the signal is symmetrical (undistorted), the depth reading will be accurate within 5% of the actual depth. If the signal is distorted, depth readings will be less accurate. When taking depth measurement, always hold the receiver at 90° to the ground.

2.11 Alternative Locate Screens

As previously mentioned, vLoc3 RTK-Pro has several alternative screens. The following section describes the operation of these screens. It is left to the user to decide which is the best screen for a particular application.

To scroll through the available screens, use long key presses on the “return” key.

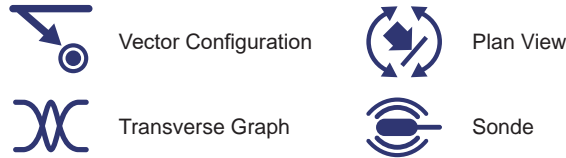

2.11.1 Vector Configuration Screen

The Vector Configuration Screen shows a cross-sectional view through the ground. A plan view is also shown to help orientate the user over the line. The Vector Screen is particularly useful where access directly over the line is not possible. The depth and horizontal displacement distances are shown, even when not directly over the line.

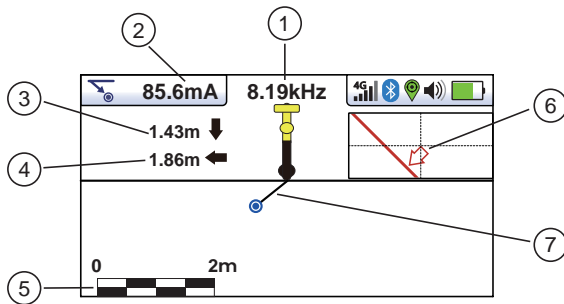

1	Frequency selected
2	Signal current
3	Depth to the target line
4	Horizontal distance to the target
5	Scaling (adjust with +/- keys)
6	Plan View of the target
7	Cross-section view that shows vectors to target

Using the Vector screen

1. Apply the signal to the target line in the usual manner and select the Vector screen using a long press on the “return” button until the desired screen appears.
2. Position the locator near the position of the target line. Use the Plan View (6) screen to help guide you towards the target line. You can imagine that the plan view is giving you a view under the ground.
3. Position yourself so that the red target line is pointing forward/back and is in the center of the screen.

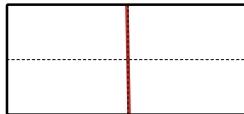

4. If the target is off the screen, an arrow will appear on the screen to help direct you to the target line.

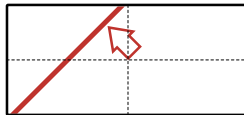

5. The cross-sectional section of the screen will respond as the target is approached. Use the + and – keys to alter the scaling if necessary.
6. There is a black line leading from the locator icon to the target line. The blue dot represents the target. Around the dot is a circle. The size of the circle indicates a confidence factor. The larger the circle, the less confident the indicated position. Generally, the actual position of the line will be within the confidence circle.

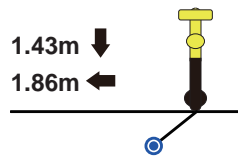

The color of the confidence circle also changes depending on the degree of confidence:

Green - Low distortion/high confidence.

Blue - Minor distortion/medium confidence, so please proceed with care.

Red - Excessive distortion/low confidence. Treat all data and measurements with caution.

- Notice that vertical and horizontal distances from the target line are displayed.

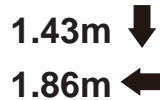

These must not be mistaken for the distance diagonally to the target; such information is not displayed. The vertical distance is the true depth from the bottom of the locator. The advantage of this is that the target's depth and position can be determined without being directly over the target line. So, in the event of an obstruction at the measuring point, data can still be gathered by placing the locator on one side of the target.

2.11.2 The Transverse Graph Screen

The Transverse Plot screen is used to analyze the field shape at a particular location, enabling the user to better feel for the data's reliability.

Two plots are generated simultaneously.

- Peak response
- Null response

In non-distorted fields, the peak and null positions should coincide, and the shape of the fields should be symmetrical about the centerline. The picture below shows a slightly distorted field.

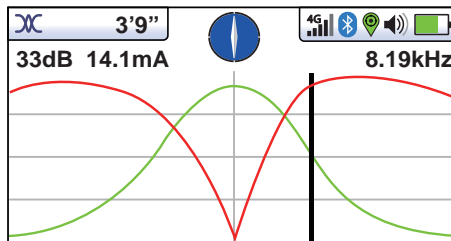

Using the Transverse Graph Screen

To take a plot, first, locate the target using one of the other locate screens. Now select the Transverse screen by a long press of the return button. Repeat this until the Transverse screen appears.

Position yourself to one side of the line such that the field markers are just on the screen. You will see that the lines automatically remove themselves after a set period of a few seconds. Clear the screen by pressing the “-” button. Now walk across the target line at a steady pace until you are on the other side of the target line. Immediately press the “+” button to save the plot on the screen.

It is still possible to walk back over the target, locating the line's position in the transverse screen while still retaining the saved screen.

2.11.3 The Plan View Screen

The plan view screen shows a picture as if you were viewing the line from above ground. When the red line is in the center and pointing forward/backward, you are directly over the line and pointing in the line's direction.

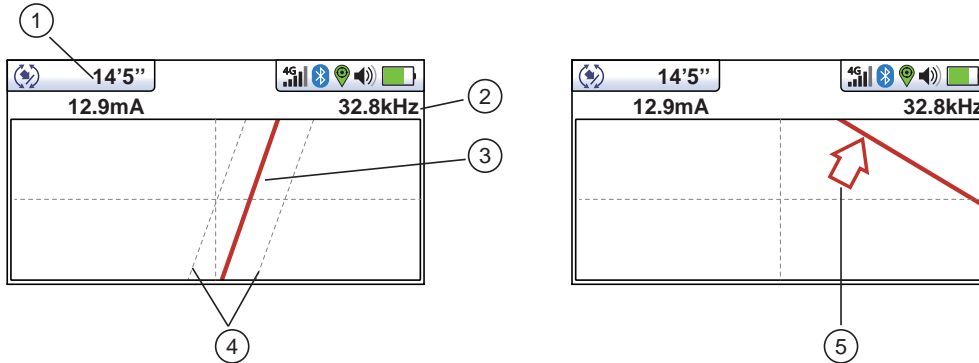

1	Depth and current readings
2	Frequency selected
3	Target line
4	Lines of confidence (closer these are to the target line indicates more confidence)
5	Arrow indicates the direction to move towards the line. It only shows when the distance to the target line is far away.

Using the Plan View screen.

1. Apply the signal to the target line in the usual way and select the plan view screen using long presses on the return button until the desired screen appears.
2. Position the locator within the approximate position of the target line. Use the plan view to help guide you toward the target line. You can imagine that the plan view is giving you a view into the ground.
3. Position yourself so that the target line is pointing forward/back and is centralized on the screen.

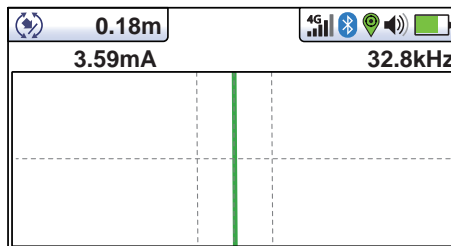

"Tram" lines on either side of the line indicate an area of confidence. The closer the tram lines are together, the greater the confidence.

In addition to the tram lines, the color of the target line also changes depending on the degree of confidence:

Green: - low distortion/high confidence.

Blue: - Minor distortion/medium confidence, proceed with care.

Red: - Excessive distortion/low confidence. Treat all data and measurements with caution.

4. If the target is off the screen, an arrow will appear on the screen to help direct you to the target line.

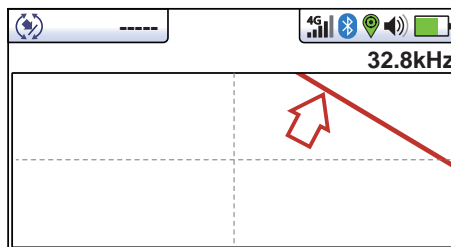

2 vLoc3 RTK-Pro Receiver

5. As long as the locator is detecting a valid signal, the depth (or current) will be available regardless of locator orientation, i.e., the locator does not need to be aligned with the target line in the forward back orientation. It is recommended that, in this mode, the current is always displayed as the signal may bleed off onto other services. Regular checks on the signal current, i.e., checking for large changes, will ensure the correct line is detected.

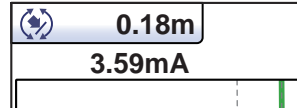

6. A short press on the info button will display the information screen. More information relating to the information screen is described in a previous section, "Information Pushbutton (Depth & Current)."

3. Using the vLoc3 RTK-Pro

3.1 Passive Locating



NOTE

The compass indicator is not active during the passive location.

Passive locating refers to the process of detecting signals that “naturally” occur on pipes and cables. These tend to fall into two categories, radio signals and power signals.

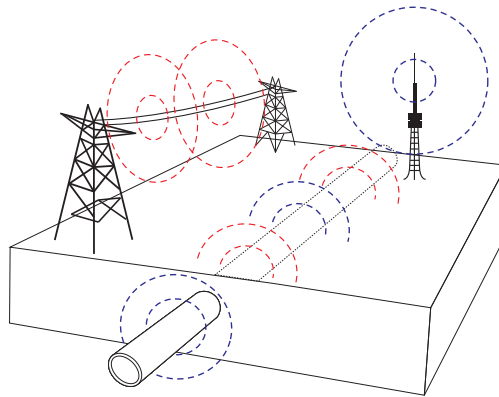

Radio signals - Low-frequency radio transmitters create radio signals. These are used for broadcasting and communications and are positioned throughout the world. As the frequencies are very low, the signals tend to penetrate and hug the earth's curvature. When the signals cross a long conductor such as a pipe or cable, the signals are re-radiated. It is these re-radiated signals that the Radio mode can detect.

Power signals - are created by mains power running in the supply cables. These signals are 50 or 60Hz, depending on the country. For instance, the UK is 50Hz power, but the USA has 60Hz. When electrical power is distributed throughout the network, some power finds its way back to the power station via the ground. These stray currents can jump onto pipes and cables and also create power signals. Note that there has to be an electrical current flowing to create a detectable signal. For instance, a live cable that is not in use may not radiate a detectable signal. Also, a very well-balanced cable, i.e., the same current flowing in live and neutral, will cancel out and may not create a signal. In practice, this is unusual as there are usually enough imbalances in the cable to create a good detectable signal.

3.1.1 Detecting Power Signals

1. Switch on the vLoc3 RTK-Pro receiver and select Power mode using the “f” button. Notice that the antenna mode indicator will be showing “Peak” or “Omni peak,” as these are the only options in the passive modes.

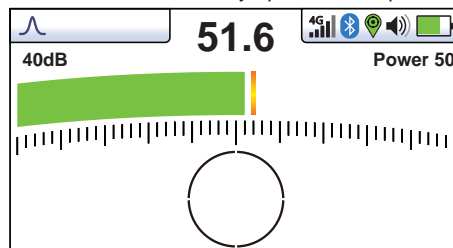

2. Hold the vLoc3 RTK-Pro vertically and away from likely positions of cables or pipes.
3. Adjust the sensitivity using the “+” and “-” buttons so that the bar graph reading is just starting to show some movement. Note that the compass feature is not available for the Power or Radio modes.

3 Using the vLoc3 RTK-Pro



NOTE

Note that there will be no sound from the speaker until the meter reading is above approximately 10% of the full scale.

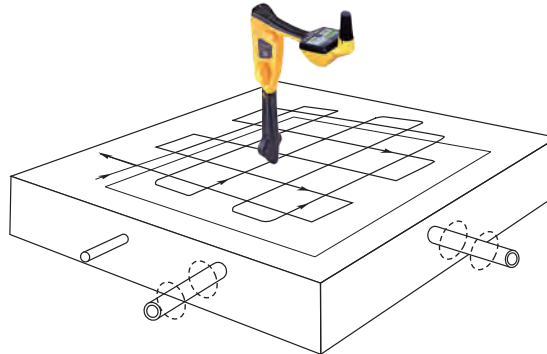

4. Keeping the vLoc3 RTK-Pro vertical, walk across the area to be checked, keeping the orientation so that the blade is in line with the direction of walking (See diagram above). If using the Onmi Peak mode, the orientation of the locator is not important.
5. Continue in a grid across the area.
6. If the meter reading starts to increase at any time, carefully move the locator side to side to detect the maximum signal. Use the peak level indicator to help confirm the correct position.

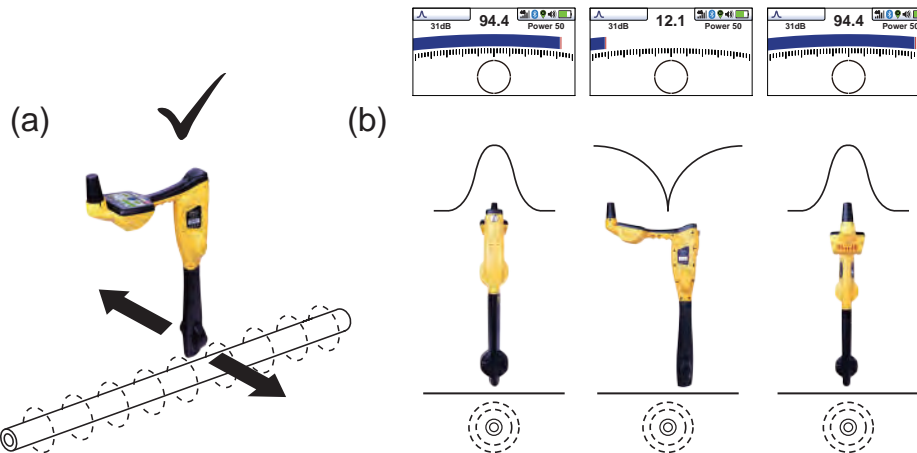

7. Rotate the vLoc3 RTK-Pro on its axis to obtain the maximum signal. The vLoc3 RTK-Pro is now directly over the line and with the blade across the line. (If using the Omni-Peak mode, there will be no change so switch to Peak mode if the direction is required).
8. The direction can also be found by rotating until the smallest signal is detected. The blade is then in line with the cable/pipe.
9. Continue to locate the line's position regularly until its course is known through the target area.

3.1.2 Detecting Radio Signals

1. Locating radio signals is very similar to detecting power signals as they are both passive signals.
2. Hold the vLoc3 RTK-Pro vertically and away from likely positions of cables or pipes.
3. Adjust the sensitivity control so that the bar graph reading is just starting to show some movement. Now follow the procedure described above in the power mode section.

3.2 Active Locating:- Applying the Transmitter

Active locating uses a transmitter to apply a precise frequency to a pipe or cable, then uses a receiver turned to detect the signal being radiated at that precise frequency. Active location frequencies can be applied by direct connection, signal clamp, or induction (This is further explained in the following sections).

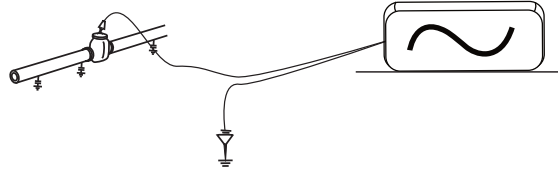

Unlike passive detecting, active locating has the benefit of the operator controlling the signals and can be more specific about what line is detected. Passive signals are also not always present on a line, so using active signals ensures more lines are detected.

Choosing the correct frequency will depend on the application, but as a general rule, select low frequencies as these tend to “bleed off” less than higher frequencies. A good general-purpose frequency is 33kHz and is a good starting point if in doubt.

When using “induction” or the “signal clamp,” the frequencies available are limited to a set of frequencies optimized for the equipment. The full range of frequencies is available in the “direct connection” mode.

For frequencies below 45 kHz, authorities such as the FCC allow higher power output to be used; for frequencies of 45 kHz and above, power output for this type of equipment is restricted to 1 watt. Therefore more power is available when lower frequencies are used.

To inject a signal requires the use of a transmitter. The signal can be injected or applied to the target line in a variety of ways.

3.2.1 Direct Connection

This method involves making an electrical connection to the cable or pipe.



WARNING
When connecting to a cable, only connect to the sheath of that cable. The direct connection leads are not designed for connection to live cables.



WARNING
Do not touch metal parts of the connection clips when connecting to the line or when the transmitter is on.

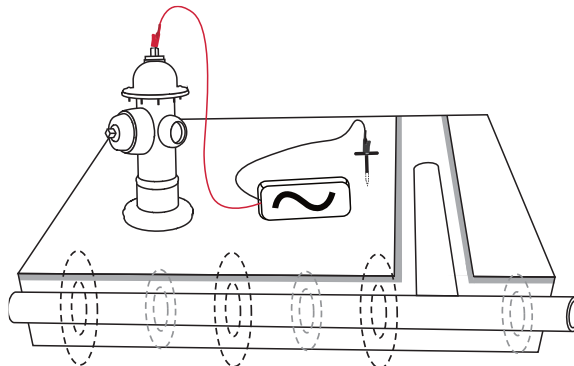

WARNING
Only authorized personnel should make connections to cables.

3 Using the vLoc3 RTK-Pro

To make a direct connection, insert the direct connection connector to the transmitter. Insert the ground stake into the ground a few meters perpendicular to the line. Connect the black lead to the ground stake. Now take the red lead and connect to the target line.

Switch on the transmitter by pressing and holding the on/off button down for a couple of seconds. Select the desired frequency, depending on the application. Check for a good connection by either noting the mA output on the display or noting the change in tone rate when disconnecting and then reconnecting the red lead (depending on the transmitter model).

Things that can affect the quality of the connection are:

1. Rusty pipe connection point: clean the connection area with a wire brush.
2. Poor grounding: try inserting the stake into damp ground. Dampen the surrounding ground with water. If still an issue, try connecting to a manhole cover surround. Avoid connecting to fence railings as these may create return signal currents along with the fencing that will interfere with the locating signal.

Always start with low output and increase the output if the received signal is not strong enough. Setting the output to high when it is not required may result in some of the signal “bleeding off” onto other services and will drain more power than necessary from the battery.

It is sometimes impossible to find a suitable projection to apply the connection clip to a ferrous material. If this is the case, use a magnet to contact the line and then clip the red clip to the magnet. A good example of this is to make a connection to a street lighting circuit. Usually, it is the practice to connect the sheath of a lighting cable to a street lamp's metallic inspection cover. Making a connection to the inspection plate will energize the cable via the plate and sheath. Usually, there is no projection on which to clip, so using the magnet on the plate provides a suitable clipping point.

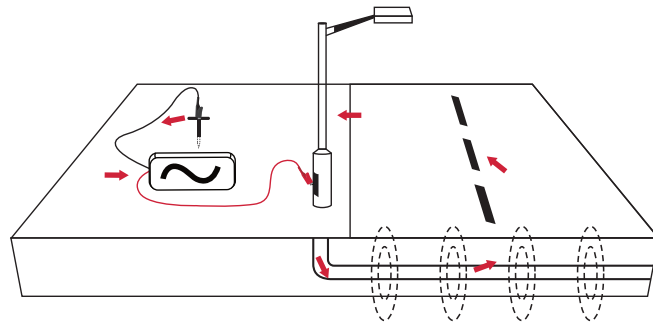

3.2.2 Transmitter Signal Clamp (for frequencies above 8kHz)

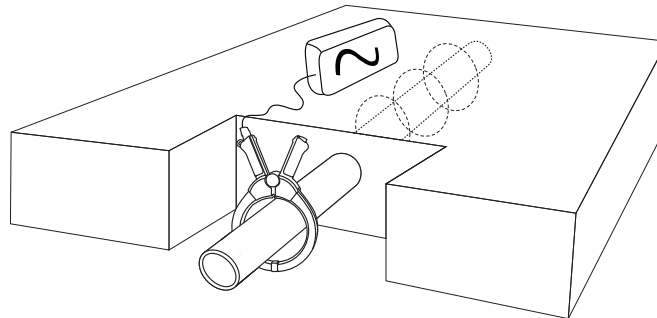

In many situations when it is not possible to make a direct connection to a cable, a signal clamp will provide an efficient and safe method to apply a locate signal.

Note that for the best results, the cable should be grounded at both ends. The clamp should be fully closed for optimal current induction. A small amount of current will still be induced if the jaws are open.

When clamping around a cable, make sure the clamp is placed below the grounding point, as shown below.

3 Using the vLoc3 RTK-Pro

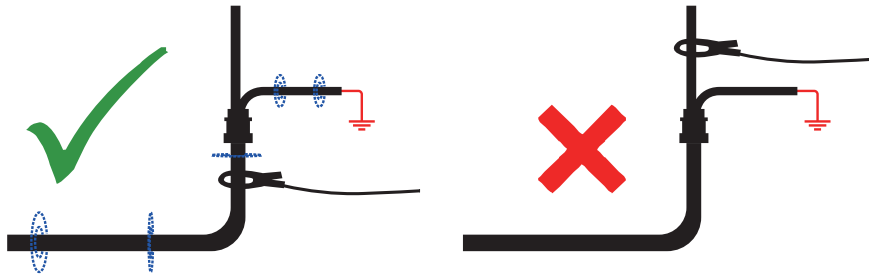

When applying a clamp close to a grounding point where multiple grounds or a grounding bus exists, ensure that you place the clamp around the target line and not to the ground bus/other grounds. This will help focus the applied signal on the target line.

Clamp Extension Rod

A useful accessory to the clamp is the extension rod:

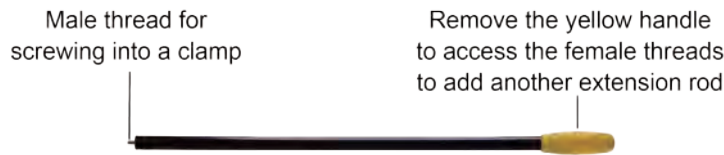

The extension rod is fitted with a 10mm threaded male stud. This male thread screws into the handle of the signal clamp to extend the distance of the clamp. This helps areas with difficult access, such as in manholes or trenches. (not to be used on uninsulated overhead power cables).

The extension rod is fitted with a female thread in the handle. The female thread allows the rods to be joined together to extend the range. To access this thread, slide the yellow handle off the rod.

To operate the clamp jaws when attached to the rod, gently pull on the clamp cord, which will open the jaws. Release cable to close them.



WARNING

Always follow the appropriate safety requirements mandated by safety legislation, safety practice, and your company's safety procedures when applying a clamp (coupler) to a cable.



BEWARE that when placing a clamp around cables carrying high current, the clamp may vibrate, jump or close violently due to induced current from the target cable.

High voltages can be induced back onto the clamp and be present at the clamp's plug in some situations. Safety practices should be followed at all times when clamping around live target lines!

Always ensure the clamp is connected to the transmitter before clamping around a line.

3.2.3 Induction (for frequencies above 8kHz)

When no direct connection lead or signal clamp is connected, the transmitter will automatically start to radiate (induce) a signal around the transmitter. These signals will penetrate the ground and couple onto buried lines. The signal will then travel along the line, which can be detected with the vLoc3 receiver.

Applying an induction signal to a line.

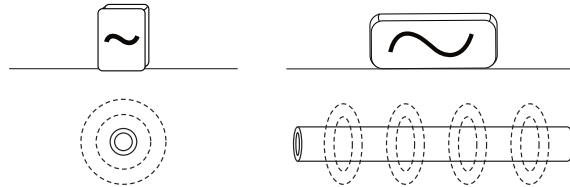

Remove all connections from the output connector. Switch on the transmitter and place it over the suspected position of the line and position it so that it is in line with the target. In the case of the Loc3 series transmitters, that is with the handle pointing along the line.

The induction mode is particularly useful where there is no access to the line, but it should be noted that this is the least efficient method of applying a signal. It is also prone to signals being applied to adjacent lines.

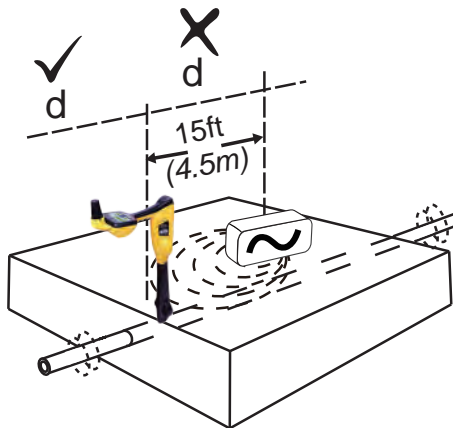

Also, note that the signal will radiate out to the sides and below the transmitter. For this reason, it is recommended that when applying a signal using the induction method, a distance of at least 4.5m (15-feet) is kept from the transmitter when pinpointing or taking depth readings.

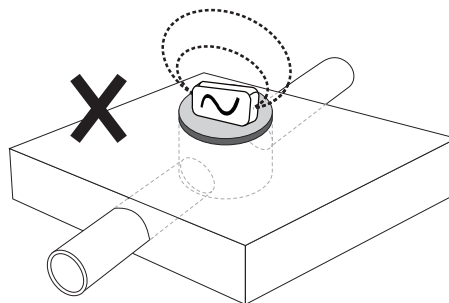

When using the induction mode, avoid placing the transmitter over metallic manhole covers. Doing so will severely reduce the transmitter's effectiveness and, in extreme cases, cause damage to the transmitter's circuitry.

3.3 Locating Active Signals

These instructions assume that the Classic Screen is selected, and Peak with Arrows mode is selected for the antenna configuration.

1. With a transmitter, apply an active locate signal to the line.
2. Set the receiver to Peak with Arrows
3. Match the frequency of the receiver to that of the transmitter.

Note that the screen will now show the addition of a compass (line direction indicator). In the presence of a locate signal, the compass will align itself parallel to the line being located. The compass helps to ensure that the operator is aware of the direction of the line.

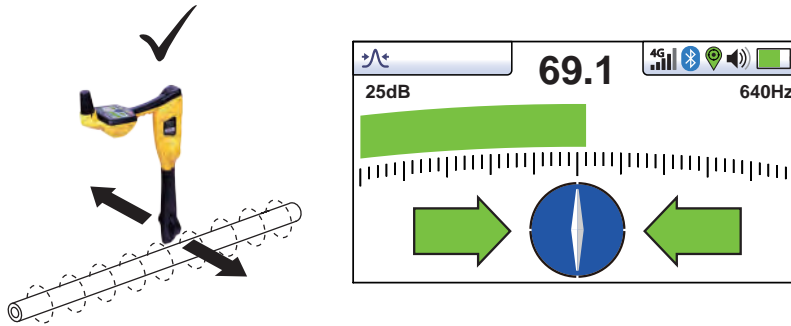

Hold the locator vertically and rotate it on its axis until the compass indicates Forward/Back, as shown above.

Adjust the sensitivity control so that the display indicates approximately 50%. Keeping the vLoc3 receiver vertical, move to the side slightly. If the bar graph increases, you are moving toward the line. If it decreases, you are walking away from it. Move toward the line as indicated by the direction arrows until a maximum signal is achieved. It may be necessary to reduce the sensitivity to keep the bar graph on the scale. This is a normal occurrence and should be expected. Try to keep the vLoc3 receiver vertical and avoid swinging it, as this may create false readings.

Move the locator side to side to ensure a maximum signal is detected. Use the peak level indicator to assist.

With the maximum signal found and the compass running Forward/Back, the vLoc3 receiver is now directly over the line and exactly across it.

If the signal is not distorted, the maximum signal's position will coincide with the position, as indicated by the arrows. If these two positions do not agree, it may be because there is signal distortion. Treat the results with caution.

Continue to trace the line to its destination or source.

If you have selected the "Omni Peak" antenna configuration, arrows will not appear on either side of the compass. This is because when in Omni mode, the line can be detected from any direction.



Tip
When in a locate screen, pressing and holding the "f" key will bring up the frequency table.

Power 50
Power 60
Radio
491Hz
512Hz
8.19kHz
8KFF
9.82kHz
32.8kHz

Use the "+" and "-" keys to navigate quickly to the desired frequency. Press the "f" key to select a highlighted choice and return to the locate screen.

3.4 Searching (sweeping) an Area in the Peak Mode

Buried utilities are not parallel to each other, and frequently they cross the area being searched at various angles and depths.

As locator antennas' response is directional (using the traditional screen), it is important to search the area in the same or similar pattern as shown.

This orients the antennas in a way that will locate any signals being radiated from the buried utility.

Once a response is found, trace, pinpoint, and mark the utility. Searching an area in this way is generally (but not exclusively) done in the "Peak" mode using passive locating.

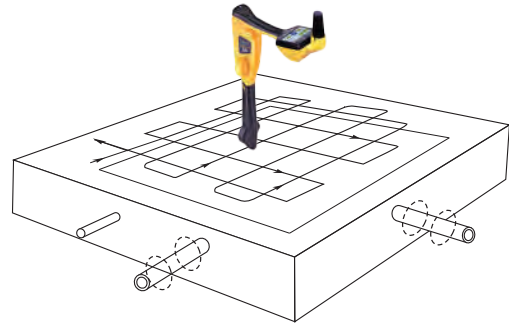

3.5 Searching (sweeping) an Area in the Omni Peak Mode

Searching in the Omni Peak mode is very similar to the Peak mode, except that it is only necessary to sweep an area in one direction.

A zig-zag motion is enough rather than a full grid action because the locator will respond to a signal from a line in any direction. It has the benefit of cutting the sweep time in half.

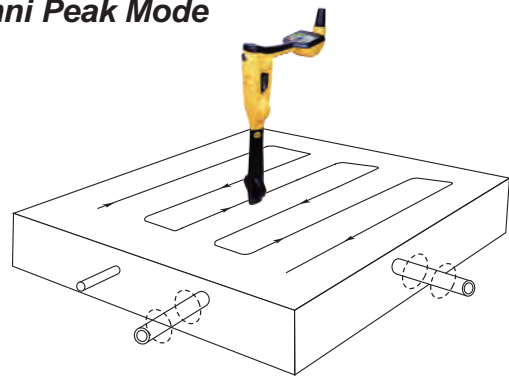

3.6 Tracing a Buried Line

Where possible, trace out from the transmitter connection point. Having "pinpointed" the line, hold the locator vertically and in front of you with the compass line indicator pointing forward/back.

Start by moving the locator left to right/right to left over the line. Keep the movement over the center of the line, i.e., the largest meter response, adjusting the gain when necessary.

Whenever practical, it should be traced to the point that provides additional confirmation of what type of service is being located (i.e., a telephone pedestal, a manhole cover, etc.).

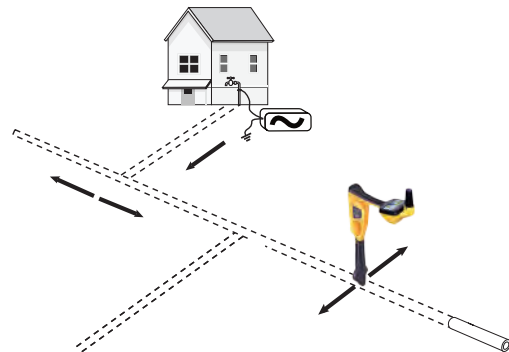

3.7 Depth & Current Measurement

If the depth measurement feature is activated, it is possible to take depth measurement estimations.

To take a depth measurement, first, pinpoint the position of the line as above. Place the vLoc3 receiver's tip on the ground, making sure it is vertical and across the line, i.e., the compass indicating Forward/Back. Momentarily press the "i" button.

The screen will change to a screen similar to the one on the right.

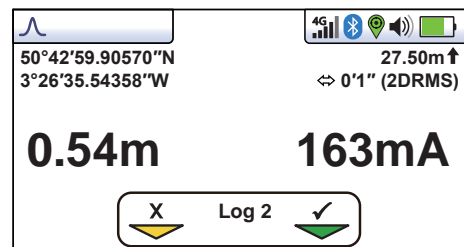

3 Using the vLoc3 RTK-Pro

If the Omni mode is selected, the locator's orientation is not important, but it is still necessary to pinpoint the line accurately before taking a depth measurement.

The signal current value will also be displayed. This feature is useful for confirming that the detected signal is radiating from the correct line. If the signal is "bleeding off" onto other services, these signals will generally be less than that of the originating signal. However, care should be taken as the signal current will gradually reduce over the length of the line, but watching for a sudden drop in current over distance should indicate that either:

1. There is a ground fault on the line, which is a shunting signal to the ground.
2. There is a "Tee" off from the mainline.
3. The operator has migrated from the connected line to a line with some signal bled across from the mainline.



NOTE

If a valid GNSS/RTK fix is available, an additional screen with a spirit level similar to the screen at the right will be shown.

It is possible to log this data into the receiver's internal memory. This is explained in detail in the "Datalogging" section.

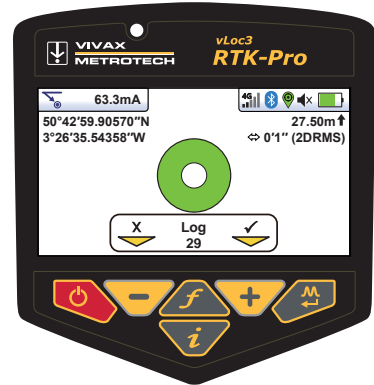

3.8 Distorted Fields

Always be aware that you are locating the signals radiating from the buried line. These radiated fields can be distorted by other lines or electromagnetic signals from buried lines. Metallic structures like crash barriers or wire mesh fences can also help to distort signals.

vLoc3 series receivers can detect the presence of possible distortion. The Vector screen has a circle drawn around the target line, which increases in size in the presence of possible distortion. The Plan view screen has "Tram" lines on either side of the calculated position, which moves further from the line as possible distortion is detected.

However, when using the traditional screen, the risk of an inaccurate location can be reduced further by doing the following:

- Check to see if other radiated fields are distorting the signal. Locate the cable, first in the "Peak" mode and then in the "Null" mode (or use the left/right arrows). The two locations should indicate that the cable is in the same place. If they do not, the signal field is distorted, and the depth and current measurement may be inaccurate.

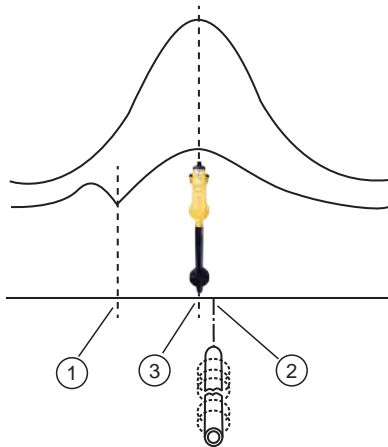

1	Null Position
2	True Position
3	Peak Position

3 Using the vLoc3 RTK-Pro

- Measure the buried line's depth by pressing the “i” pushbutton briefly to measure depth and current. The depth should be approximately in line with the “as-built” plans available. If no plans are available, logic would still help assess the situation (for instance, if you are looking for a shallow CCTV distribution cable and the depth indicated is 5-feet (1.5m), it should raise a concern).
- Take a depth reading on the ground and then raise the locator approximately 1-foot or 0.25m and repeat the depth measurement. The depth should increase by this amount. If not, treat the information with caution.
- A depth reading on congested areas or close to bends or tees may be inaccurate due to distorted fields.

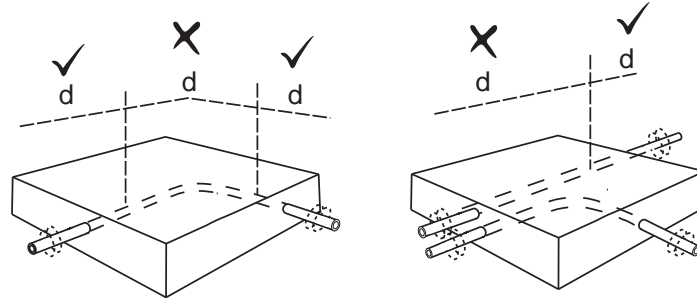

3.9 Sonde Location Mode

A Sonde is typically used for locating non-metallic pipes or ducts or the camera end of a sewer inspection camera. Low-frequency versions (512Hz/640Hz) can transmit through some metallic pipes such as cast iron pipes which is why they are frequently used with sewer inspection cameras.

The Sonde Location mode is a Peak mode which means that the bar graph and audio will grow when approaching the sonde and at their maximum when over the sonde.

Sonde screen:

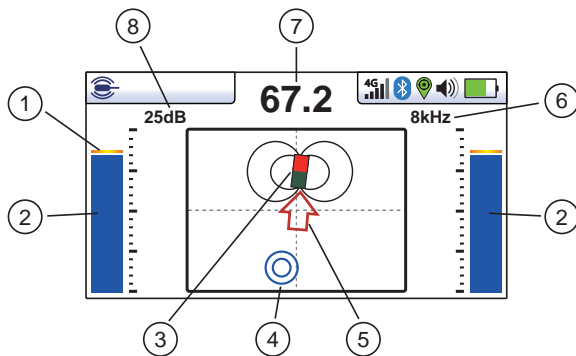

1	Peak signal detector
2	Signal strength bar graph
3	Sonde icon
4	Null point
5	Direction to sonde
6	Frequency selection
7	Numeric signal level (mirrors the bar graph)
8	Gain setting

The Sonde transmitting coil radiates differently than that of a line.

Due to this construction, the sonde gives a different “Peak” pattern note that there are three distinct peaks – a small peak – a large peak – a small peak with two “Nulls” between the peaks. The sonde is located under the center of the “large peak.”

The vLoc3 receivers detect the two “Null” signals and the position of the main “Large Peak.” It uses this information to provide a reliable and efficient method of sonde location.

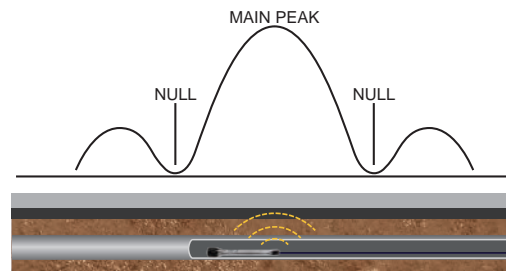

3 Using the vLoc3 RTK-Pro

The vLoc3 Sonde Screen will display the Large Peak as a Sonde icon and the Null Points as double blue circles, as shown in the illustration to the right.

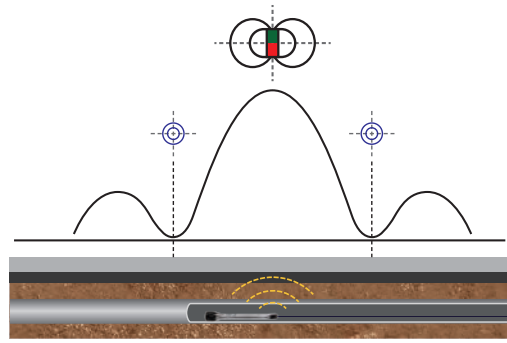

Method

1. Switch on the vLoc3 receiver and use long presses on the Enter key to enter the Sonde screen.
2. Press the "f" key to select the sonde frequency matching the sonde being located.
3. Insert the activated sonde into the pipe. Push the sonde about 10 – 12-feet (3-4m) into the pipe.
4. Hold the locator vertically and stationary with the tip on the ground.
5. When the receiver is within the sondes range, a screen similar to the one below will be seen. On the screen, the arrow will be pointing to the sonde. The bar graphs on either side of the screen are identical and indicate the signal strength. Use the + and – keys to alter the receiver gain to keep the signal within the bar graph's limits.

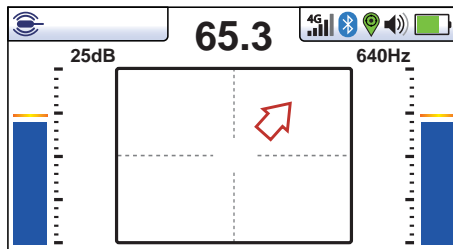

6. If the bar graph is not steady, it will most likely be because the sonde is not within range. In this case, hold the locator at approximately 45 degrees to the ground and rotate the locator around a full 360 degrees around you. Note the strongest signal's direction and walk towards it until the bar graph shows a steady signal. Now revert to step five above.
7. Walk slowly in the direction of the arrow.
8. A double circle will appear on the screen, indicating the position of a null signal. Walk toward it and position it over the crosshairs of the screen. Now rotate the locator so that the arrow is pointing forward.

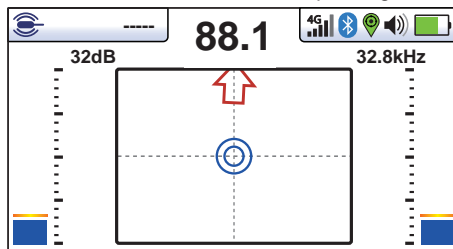

9. Keeping the null indicator on the vertical line, walk toward the arrow.
10. A Sonde icon will soon appear. Keeping the locator vertical, carry on walking toward the Sonde until it is positioned on the crosshairs. The locator is now directly over the Sonde. The arrow will flip forward and back as the position is crossed.

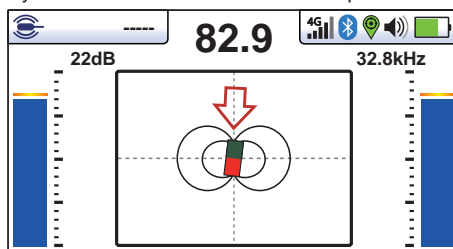

3 Using the vLoc3 RTK-Pro

11. Note that it may be necessary to confirm the Sonde position when directly over the Sonde, left to right. Do this by moving the locator left to right to identify the strongest signal's position, as indicated on the bar graph. At this time, the depth of the Sonde will be displayed at the top of the display.
12. Having pinpointed the Sonde position, it can now be pushed into a new location and the process repeated. It is advisable to keep the survey intervals too short distances such as six feet (two meters), making locating easier.

3.10 Walk Back Feature

The RTK-Pro's walk back feature will lead the user to previously collected GNSS coordinates.

To use this feature

1. Update the RTK-Pro's firmware using the MyLocator3 desktop app.
2. Create an account in the VMMap Web Portal at <https://vmmap.vivax-metrotech.com/login>.

3.10.1 VMMap Web Portal

Add a Walk Back Point - Add the list of desired points into the VMMap web portal. These desired points will come from surveys already stored in the VMMap cloud and collected with an RTK-Pro receiver.

1. The survey list opens a survey containing the desired point that would need to walk back to.
2. Once the survey is open start from the "Map" tab.
3. On the top left an option with a slider labeled "Display Walk Back." Select this toggle to view the map's points.

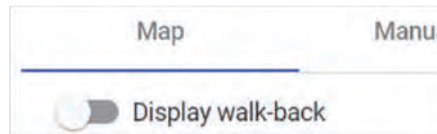

4. The list of points collected in the survey job is displayed on a map similar to the below.

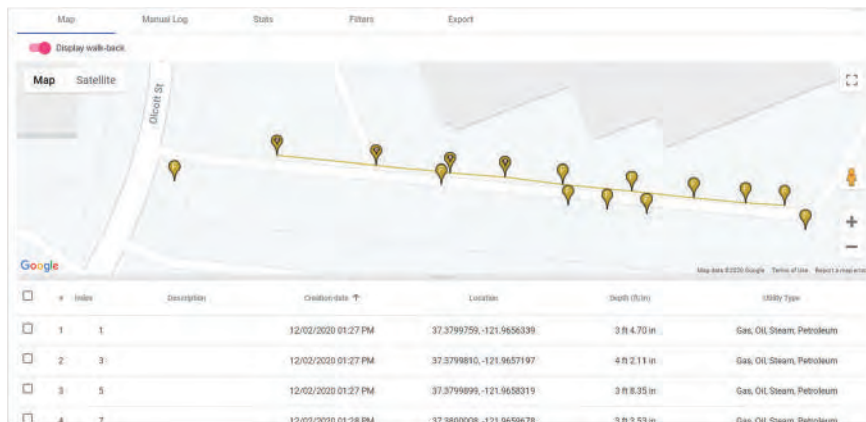

5. Note the check box next to the number of points contained in the survey. Identify the point to be added to the walk back list and click on the check box.



Index	Description	Creation date	Location	Depth (ft/in)	Utility Type
<input checked="" type="checkbox"/>	1 WB-1	12/02/2020 01:27 PM	37.3799759, -121.9656339	3 ft 4.70 in	Gas, Oil, Steam, Petroleum
<input type="checkbox"/>	2	12/02/2020 01:27 PM	37.3799810, -121.9657197	4 ft 2.11 in	Gas, Oil, Steam, Petroleum
<input type="checkbox"/>	3	12/02/2020 01:27 PM	37.3799899, -121.9658319	3 ft 8.95 in	Gas, Oil, Steam, Petroleum
<input type="checkbox"/>	4	12/02/2020 01:28 PM	37.3800008, -121.9659678	3 ft 5.53 in	Gas, Oil, Steam, Petroleum

6. When logs are selected, the letters "WB" will show beside them, and the map pins are temporally animated.

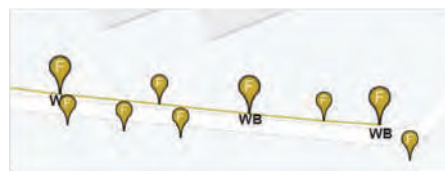

3 Using the vLoc3 RTK-Pro

7. Once the desired points are selected an automatic description is assigned. These descriptions can be edited if so desired.

#	Index	Description	Creation date	Location	Depth (ft/in)	Utility Type
<input checked="" type="checkbox"/>	1	Transmitter connection	12/02/2020 01:27 PM	37.3799759, -121.9656339	3 ft 4.70 in	Gas, Oil, Steam, Petroleum
<input type="checkbox"/>	2	3	12/02/2020 01:27 PM	37.3799810, -121.9657197	4 ft 2.11 in	Gas, Oil, Steam, Petroleum
<input checked="" type="checkbox"/>	3	POI near meter	12/02/2020 01:27 PM	37.3799899, -121.9658319	3 ft 8.35 in	Gas, Oil, Steam, Petroleum
<input type="checkbox"/>	4	7	12/02/2020 01:28 PM	37.3800008, -121.9659678	3 ft 3.53 in	Gas, Oil, Steam, Petroleum
<input checked="" type="checkbox"/>	5	POI near valve	12/02/2020 01:28 PM	37.3800138, -121.9661177	2 ft 8.85 in	Gas, Oil, Steam, Petroleum

8. When all the needed points are selected click on the "Add" option on the bottom left.

#	Index	Description	Creation date	Location	Depth (ft/in)	Utility Type
<input checked="" type="checkbox"/>	1	Transmitter connection	12/02/2020 01:27 PM	37.3799759, -121.9656339	3 ft 4.70 in	Gas, Oil, Steam, Petroleum
<input type="checkbox"/>	2	3	12/02/2020 01:27 PM	37.3799810, -121.9657197	4 ft 2.11 in	Gas, Oil, Steam, Petroleum
<input checked="" type="checkbox"/>	3	POI near meter	12/02/2020 01:27 PM	37.3799899, -121.9658319	3 ft 8.35 in	Gas, Oil, Steam, Petroleum
<input type="checkbox"/>	4	7	12/02/2020 01:28 PM	37.3800008, -121.9659678	3 ft 3.53 in	Gas, Oil, Steam, Petroleum
<input checked="" type="checkbox"/>	5	POI near valve	12/02/2020 01:28 PM	37.3800138, -121.9661177	2 ft 8.85 in	Gas, Oil, Steam, Petroleum

Items per page: 5 | 1-5 of 5

9. A pop-up window will appear with the option of a drop-down with available RTK-Pro serial numbers. Select one or more serial numbers of receivers that would need the Walk Back points assigned. Click on the "Save" button.

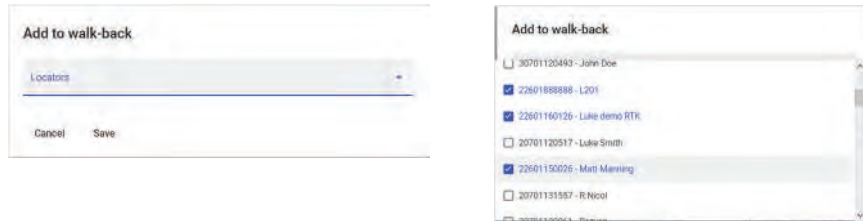

10. To edit and viewpoints added to the Walk Back list go to the Walk Back tab.

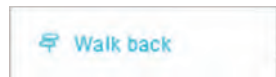

11. Here an overview of the Walk Back points assigned to users within the company will be displayed with open or completed status.

#	Index	Name	Description	Latitude	Longitude	File	Ref	User	Created on	Completed on
<input type="checkbox"/>	1	23170421031	320211129-140311142201WB-1	38.9389272	-107.47604			Bill Mackie	11/27/2020 05:28 AM (GMT-0800)	
<input type="checkbox"/>	2	23011300218	320211119-1403122714031New Street	37.3800364	-121.9660290			Josee Pimenta	11/20/2020 09:32 AM (GMT-0800)	
<input type="checkbox"/>	3	23011300218	320211119-1403122714031New Building	37.3800315	-121.9661419			Josee Pimenta	11/20/2020 09:32 AM (GMT-0800)	
<input type="checkbox"/>	4	22911400218	320211119-1403122714031WB-1	37.3800391	-121.9660348			Josee Pimenta	11/20/2020 09:32 AM (GMT-0800)	
<input type="checkbox"/>	5	23011300218	320211119-1403122714031New Street	37.3800284	-121.9660290			Josee Pimenta	11/20/2020 09:32 AM (GMT-0800)	
<input type="checkbox"/>	6	23011300218	320211119-1403122714031New Building	37.3800315	-121.9661419			Josee Pimenta	11/20/2020 09:32 AM (GMT-0800)	
<input type="checkbox"/>	7	22811300218	320211119-1403122714031WB-1	37.3800391	-121.9660348			Josee Pimenta	11/20/2020 09:32 AM (GMT-0800)	
<input type="checkbox"/>	8	23011400218	320211119-1403122714031New Building	37.3800315	-121.9661419			Josee Pimenta	11/20/2020 09:32 AM (GMT-0800)	
<input type="checkbox"/>	9	23011400218	320211119-1403122714031WB-1	37.3800374	-121.9660043			Josee Pimenta	11/19/2020 01:29 PM (GMT-0800)	
<input type="checkbox"/>	10	20701127001	320211119-1403122714031WB-1	37.3801402	-121.9660287			Rubén (Rubén)	11/11/2020 09:09 AM (GMT-0800)	
<input type="checkbox"/>	11	20701127001	320211119-1403122714031WB-1	37.3799947	-121.9660803			Rubén (Rubén)	11/11/2020 09:49 AM (GMT-0800)	
<input type="checkbox"/>	12	20701127001	320211119-1403122714031WB-1	37.3800176	-121.9661612			Rubén (Rubén)	11/11/2020 09:48 AM (GMT-0800)	
<input type="checkbox"/>	13	20701127001	320211119-1403122714031WB-1	37.3800817	-121.9660975			Rubén (Rubén)	11/11/2020 09:48 AM (GMT-0800)	

12. To view completed Walk Back points, toggle the "Show completed points" option.

3 Using the vLoc3 RTK-Pro

3.10.2 Performing an RTK-Pro Walk Back

Now that the Walk Back points have been selected, the VMMMap cloud uses the RTK-Pro receiver containing the assigned receiver serial number and Walk Back points.

1. In the RTK-Pro menu, navigate to scroll to **Walk Back** and enter the sub-menu option.

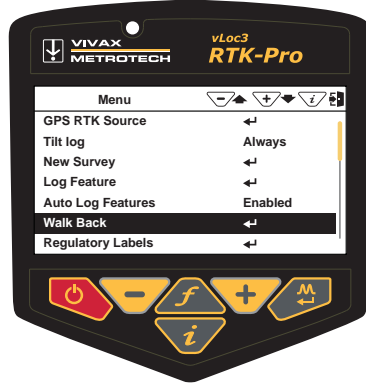

2. At the **Get list** option and press the enter pushbutton to bring up the list of Walk Back points allocated to this receiver's serial number from the VMMMap Cloud.

3. Once the Walk Back points have been downloaded from the VMMMap Cloud, they are displayed in a list by the Walk Back point description.

Scroll to the point needed to Walk Back to and click on the enter pushbutton.

4. Once the Walk Back point is selected a screen similar to the one shown on the right will be seen.



On this screen the following is displayed:

- Shows your current Latitude, Longitude and Altitude and horizontal accuracy in 2DRMS.
- Shows the horizontal distance from the locator GNSS antenna to the Walk Back point in the bottom right corner of the screen.
- When further from the Walk Back point and moving a guidance arrow points towards the Walk Back point.

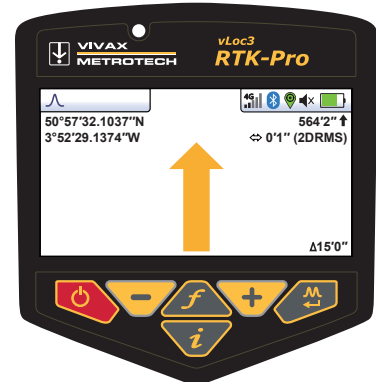

Note:

- The Guidance arrow assumes you are holding the locator in front of you, with the bottom of the screen closest to you.
- When stationary, no guidance arrow is shown.

3 Using the vLoc3 RTK-Pro

- Follow the guidance arrow to get near the Walk Back point. Once within 10-feet (3m), a crosshair icon will be displayed. A spirit level is shown. The center of the spirit level represents the location of the GNSS antenna. You must maintain the locator's orientation and move forwards and backward, left and right, and not rotate the locator.



- As you walk toward the Walk Back point, you aim to get the red cross in the center of the spirit level. Now the GNSS antenna is over the Walk Back point.

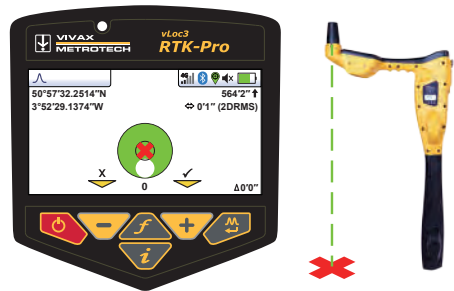

- As you tilt the locator to get the GNSS antenna over the locator's foot, you aim to get the spirit level bubble into the center of the spirit level. When you have the locator's foot on the ground, and the Walk Back point the red cross and the spirit level bubble will be in the center of the spirit level, as shown in the illustration to the right.

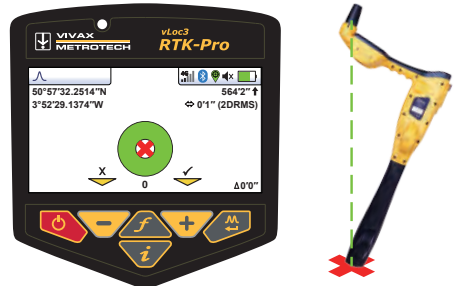

- Use the + key to log the Walk Back as complete. This records how accurately the Walk Back was performed and marks the Walk Back as complete in the VMMap Cloud.



Delete Show completed points

Filter by any column

#	<input type="checkbox"/>	Serial Number	Survey	Description	Latitude	Longitude	Point	Dist	Size	Created on	Completion
9	<input type="checkbox"/>	22601146010	7030-11-19-146573732244P3		37.3807233	-121.9452650	0.3543702	0.0046726	Jobue Points	11/19/2020 01:39 PM (GMT-0800)	11/19/2020 01:47 PM (GMT-0800)
10	<input type="checkbox"/>	22601146010	7009-11-19-146573732244P2		37.3802574	-121.9452643			Jobue Points	11/19/2020 01:39 PM (GMT-0800)	
11	<input type="checkbox"/>	22601146010	Default monuments	Monument 2	37.3807285	-121.9453043	0.3642171	-0.0099548	Jobue Points	11/19/2020 12:39 PM (GMT-0800)	11/19/2020 02:12 PM (GMT-0800)
12	<input type="checkbox"/>	22601146010	Default monuments	Monument 3	37.3802604	-121.9452954	0.3431048	0.0003543	Jobue Points	11/19/2020 12:39 PM (GMT-0800)	11/19/2020 02:13 PM (GMT-0800)



*Please note some screens and images have been simulated and do not represent the final product.

3.11 Feature Logging

Feature Logging is for collecting additional information on an underground utility or its surrounding above-ground point of interest.

3.11.1 Requirements:

- Microsoft Excel® (version 2008 and above with .xlsx format)
- MyLocator3 Desktop App (Available free of charge on www.vivax-metrotech.com/support/downloads)

3.11.2 Setup and Import of Data Dictionary

First, one must set up a data dictionary to easily tag the data collected during the locating survey. Below is the process of how to create and load the data dictionary into the RTK-Pro using MyLocator3.

1. Setup the data dictionary with assigned definitions and code
 - a. The definition is human-readable when the list is presented.
 - b. The code is useful when filtering data when post-processing.
2. In this example we will use Microsoft® Excel® to set up the data dictionary
3. Start with a new document and single sheet.
4. Two columns are required. One contains the “Definition” and the other a “Code” associated with that definition.
5. The first column, “A,” will contain the feature definition as seen below. A maximum of 48 characters may be entered. The text entered here will be displayed on the RTK-Pro when the feature log list is presented to the user.

	A	B	C
1	Gas Line		
2	Gas Line Vent		
3	Gas Meter		
4	Gas Manhole		
5	Gas Service Valve		
6	Gas Valve		
7	Gas Well		
8	Electric Meter		
9	Electric Manhole		
10	Power and Light Pole		
11	Power Pole		
12	Electric Riser/Pedestal		
13	Water Line		
14	Water Line Vent		
15	Water Meter		

Column A - Feature Definition

6. In the second column, “B” enter a code associated with the definition. Using codes will make sorting or parsing data easier after the data has been collected. The below contains a maximum of nine characters.

	A	B	C
1	Gas Line	GL	
2	Gas Line Vent	GLV	
3	Gas Meter	GME	
4	Gas Manhole	GMH	
5	Gas Service Valve	GSV	
6	Gas Valve	GVALVE	
7	Gas Well	WELLG	
8	Electric Meter	EME	
9	Electric Manhole	EMH	
10	Power and Light Pole	PLP	
11	Power Pole	PP	
12	Electric Riser/Pedestal	UBOX	
13	Water Line	WL	
14	Water Line Vent	WLV	
15	Water Meter	WME	

Column B - Feature Code

7. Continue to add feature definitions as needed with a maximum of 200.
8. Save the file as Microsoft® Excel® Workbook (.xlsx) to your local storage drive.
9. Open MyLocator3 and connect the RTK-Pro using the USB cable.

10. Click on the tab on the left labeled “Feature Logging.”

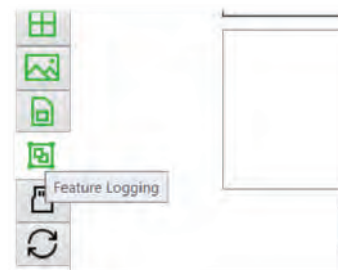

3 Using the vLoc3 RTK-Pro

- In the Feature Logging sub-menu, select the "Open" to select the .xlsx file created in the previous steps.

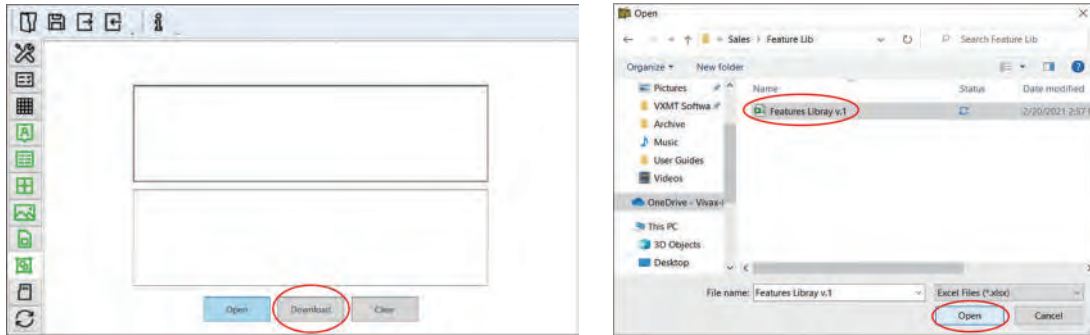

- Once the file has been selected a review of the containing features will be displayed by pressing the small triangle next to "Feature Definitions."

- Now select "Download" to download the data dictionary into the RTK-Pro receiver.

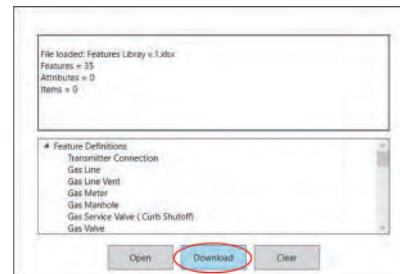

- Power off the unit, so the changes take effect. At the next power-up the data dictionary will be available in the receiver.

3.11.3 Logging Features

To collect a feature, enter the main menu and scroll to the "Feature Log" menu option.

There are two ways in which feature logs operate:

- The first method is labeled as "Log Feature" in the main menu.
- The second method is labeled "Auto Log Feature," which is also found in the main menu.

We will first cover the **Log Feature** to collect points of interest that do not carry a locating signal tone. For example, a handhole cover is present but not part of the underground utility.

Logging Feature:

- Place the RTK-Pro on the point of interest.
- Long press on the "i" key to enter the main menu and scroll to Log Feature
- Once entered, the info-screen appears. Press the "f" pushbutton to open the data dictionary list with all the available definitions.

Use the "+" and "-" pushbuttons to scroll the list. Once the required feature is reached, press the "Return" pushbutton.

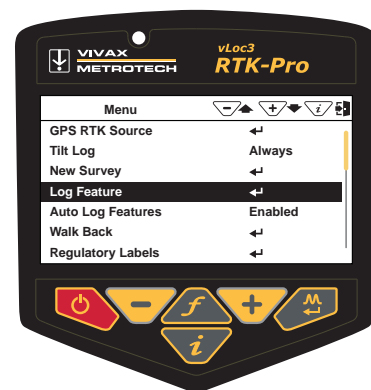

Scroll to Log Feature

- Press the "+" pushbutton to log. Now the receiver will display the spirit level to tilt the receiver to align the GNSS antenna.

3 Using the vLoc3 RTK-Pro

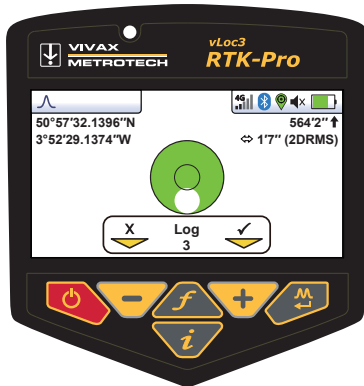

Spirit Level is displayed

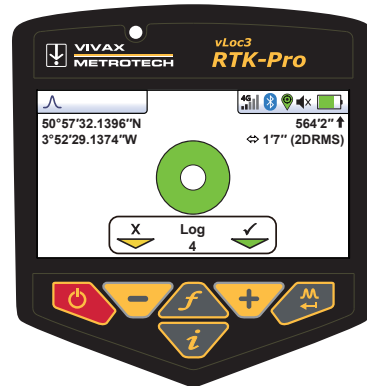

Aligned GNSS Antenna

3.11.4 Auto Log Feature

To enable the Auto Log Function, navigate to the main menu and find **“Auto Log Feature.”** Two options are presented to the user **Enabled** or **Disabled**. Enabling this option will tag all the logs with a specified feature. Enabling the Auto Log Feature options helps with tagging data on the underground utility that will need to remain the same for more than one log. Leave the user menu by pressing the “i” pushbutton.

To collect data with the Auto Log Feature enabled perform the following:

1. Locate the underground utility.
2. Enter the information screen by pressing the “i” pushbutton.
3. Press the “f” pushbutton to display the **list of available features** in the data dictionary.
4. Use the “+” and “-” pushbuttons to scroll the list. Once the required feature is reached, press the “Return” pushbutton.
5. Use the “+” and “-” pushbuttons to scroll the list. Once the required feature is reached, press the “Return” pushbutton.
6. Once the selected feature is selected, the screen will change to the tilt screen to align the spirit level to store the log.



List of Available Features

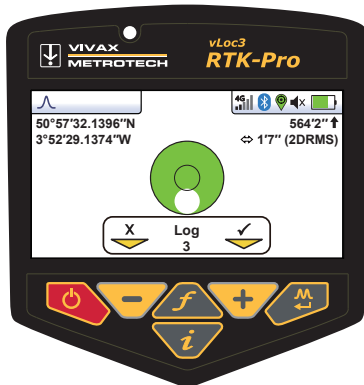

Spirit Level is displayed

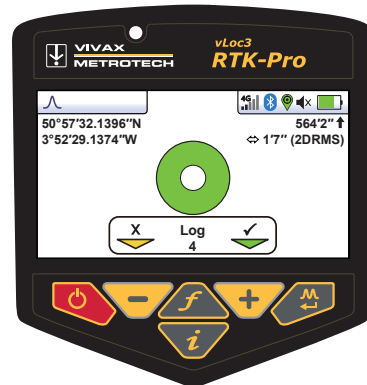

Aligned GNSS Antenna

7. The screen will now revert to the locate screen. Now you can continue to locate the utility. Continue to collect data as needed. If the feature needs to be changed press the “f” pushbutton to open the data dictionary.



Tip

From the moment the automatic object recording is activated, every point recorded is provided with a feature. If you no longer want this, switch off the “Auto Log Features” recording in the main menu.

3.11.5 Feature Logs in VMMap Cloud

Once feature logs are synced with the utility survey in the cloud, a unique pin is assigned. The example below shows the location pin is brown; it also contains an "F" label.

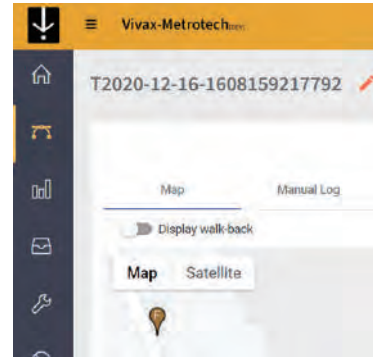

Location Pin

AS	AT
s	feature code
	feature description
	GL
	Gas Line
	GL
	Gas Line
	GL
	Gas Line
	GL
	Gas Line
	GL
	Gas Line
	GL
	Gas Line
	GL
	Gas Line
	GL
	Gas Line

When exporting the data to a .csv or .shp file, the feature log data is also carried over. Below you can see the column labeled "Feature Code" and "Feature Description."

4. Data Logging

The RTK-Pro has an internal memory to store locator data. (Or if activated, can be sent to the “cloud”) The available storage size is four gigabytes, which relates to many thousands of records.

The user records the records whenever the “+” button is pressed while in the “Information” screen.

Data can be stored relating to a standard locate or relating to any of the receiver accessories. (apart from the Remote antenna accessory).

Each time the self-test routine is run or a Warning or Alarm goes off the results are automatically recorded in the equipment with no user input.

To store a record first, locate a point of interest. There will be an extra step to perform when taking readings recorded in the log or sent to the cloud. The locator can provide cm mapping accuracy. For technical reasons, the GNSS antenna is positioned slightly ahead of the locator. This displacement is compensated for by tilting the locator backward until the antennas are vertically aligned.

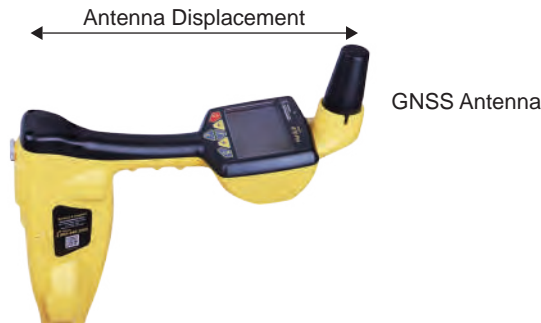

4.1 How to Create Data Logs

Procedure to log a point

1. Locate the line in the usual way
2. Press the Info key, and the screen to the right will appear.
3. Press the “+” key to log the data. The log number will increase, indicating that the data log was stored.

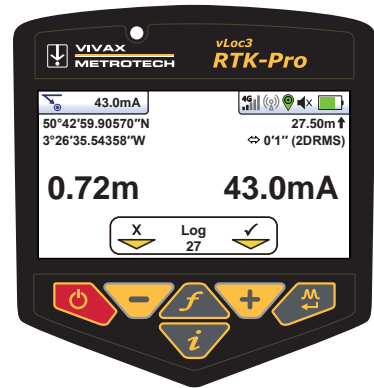

4. After the data log is accepted, a new screen with a digital spirit level is shown.

To record the RTK information, tilt back the locator until the bubble is centralized in the spirit level.

(Otherwise, press the Info key to go back to the locate screen)



- After a few seconds, the compensated reading will automatically log, and the log number will increment, then the display will return to the locate screen.

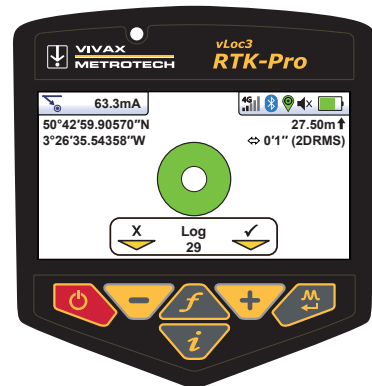

4.2 Pairing the receiver with dataloggers, mobile phones and other external devices.

The RTK-Pro receiver comes with factory-installed Bluetooth. Because of this, the RTK-Pro receiver cannot be fitted with the Transmitter Link option. These two options are mutually exclusive.

Bluetooth pairing with external devices.

- Switch on the external device.
- Switch on the vLoc3 RTK-Pro and enter the User setup menu by a long press on the “i” button.
- Use the “+” and “-” keys to scroll to and select the “Bluetooth Pairing” option.
- Press the Enter key.
- Press the Enter key to start a “Bluetooth search” for external devices.
- A list of available devices will be shown.
- Scroll to the desired external device, press the Enter key.
- Double press the “i” button to return to the main screen.
After a few seconds, the Bluetooth icon should turn blue, indicating the device has paired successfully.

The unit will remember the pairing even after switching off. However, the unit can only remember one unit at a time, so if the unit is paired with another device, the settings will be replaced.

GPS (Global Positioning System)/GNSS (Global Navigation Satellite System)

Typically the RTK-Pro utilizes its internal GNSS antenna, but the RTK-Pro can also utilize location data from an external GPS/GNSS device. For this, the RTK-Pro needs to be paired with an external device (see the previous section on pairing external devices).

Once paired with an external device, the RTK-Pro will await valid GPS data from the external device. The GPS icon will turn green when a valid GPS signal is detected. It can take from a few seconds to a few minutes, depending on the device and whether it is doing a “cold” or “hot” start. Also, note that the bubble level will not be displayed in the Info screen.

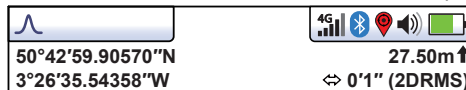

4.3 Transferring Data from the vLoc3 Receiver to a Computer



MyLocator3

One method of transferring data is to use the vLoc3 Series Configurator Tool, "MyLocator3". This free desktop program can be downloaded from the Vivax-Metrotech website.



Another method to access the locator data is by using the VMMMap App, which will store all the locator's data in the web portal. See our website under "Apps" to learn more.

To transfer the locator's data logs, use the RTK-Pro configurator tool, Mylocator3. This desktop application can be downloaded from the Vivax-Metrotech website at www.vivax-metrotech.com in the apps section.



TIP
To view Google Earth .kml files the Google Earth app is needed.
This free app can be found by doing a google search for “Google Earth.”

4.3.1 The MyLocator3 Desktop App

This section describes the user operation of the MyLocator3 PC application. MyLocator3 is a desktop PC application capable of downloading code and configuring the vLoc3 series of locators. The first part of this document (Basic Operation) describes usage not requiring a USB security dongle. The second part of this document (Advanced Features) describes usage requiring a security dongle.

MyLocator3 is a free downloadable App available at www.vivax-metrotech.com in the Apps section. Follow the instructions to download and install the application. A “MyLocator3” icon will appear on the computer desktop after the app is installed.

Connect your vLoc3 series receivers to the computer via the mini USB connector, which can be found under the battery cover flap. Launch MyLocator3 by double-clicking on the icon.

4.3.2 MyLocator3’s Basic Operation

MyLocator3 operation, not requiring a USB security dongle.

4.3.2.1 Updates Page

When a locator is first connected to the PC, the “Updates Page” will be displayed. The updates page will show the locator variant type, the locator serial number, and the running firmware version in the upper left-hand boxes. The upper right-hand box will show information about the MyLocator3 PC application.

Clicking on the Clock symbol sets the locator time to UTC. To check local and UTC, hover over the Icon, and the times will be displayed to the right, flashing alternately.

Checking the “Auto Load Config” box ensures the locator's configuration setting is automatically uploaded to the MyLocator3 app when the locator is connected.

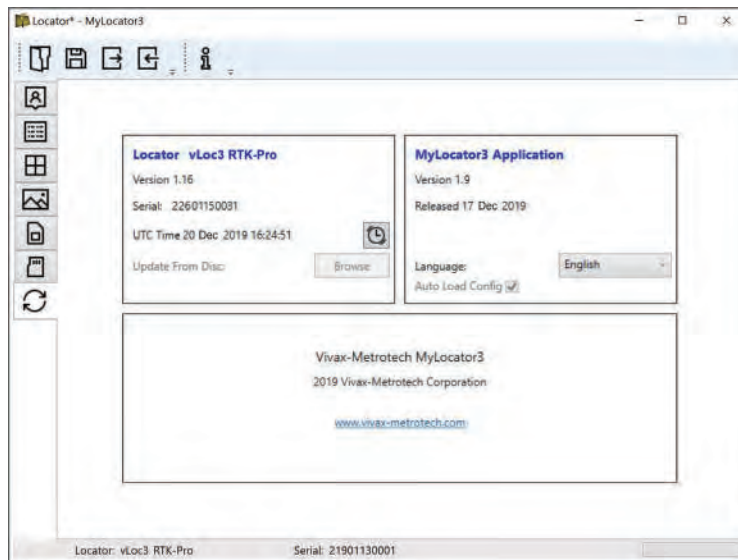

The MyLocator3 startpage

MyLocator3 can also be viewed in several language options. Click on the pull-down menu to select the desired option.

4.3.2.2 Application Update

Every time the MyLocator3 Application is started, its version number is checked against the latest version available on the Vivax-Metrotech server. The user is notified if an update is available, as shown below. This feature will only be available if the computer is “online.”

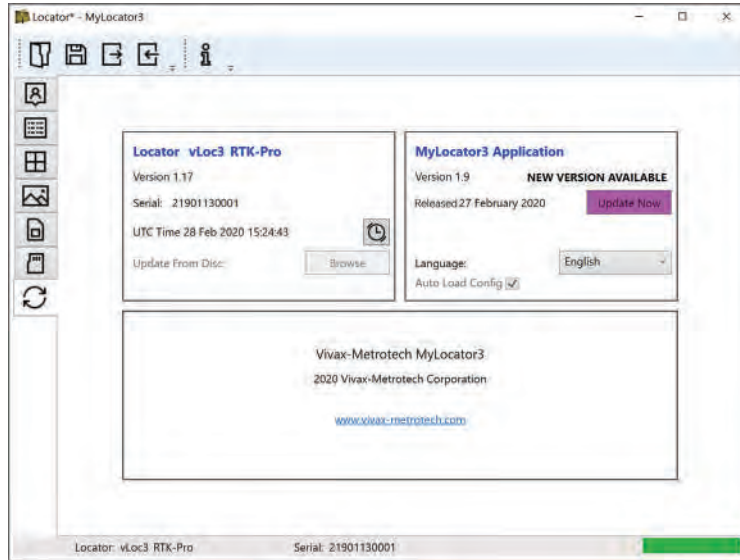

The update notification

Clicking on the Update Now button will download the latest version from the Vivax-Metrotech server, which the user can install.

4.3.2.3 Locator Firmware update

Each time a locator is connected to the PC, its firmware version is checked against the latest version available on the Vivax-Metrotech server and the user is notified if an update is available, as shown below. This feature will only be available if the computer is “online.”

Clicking on the Update Now button will fetch the latest version from the server and then download it to the locator.

The “Update From Disc” feature will only be available if a suitable dongle is also attached to the PC. This feature allows the user to install older versions of firmware stored on the computer, although it is advised that only the latest version of firmware is used.

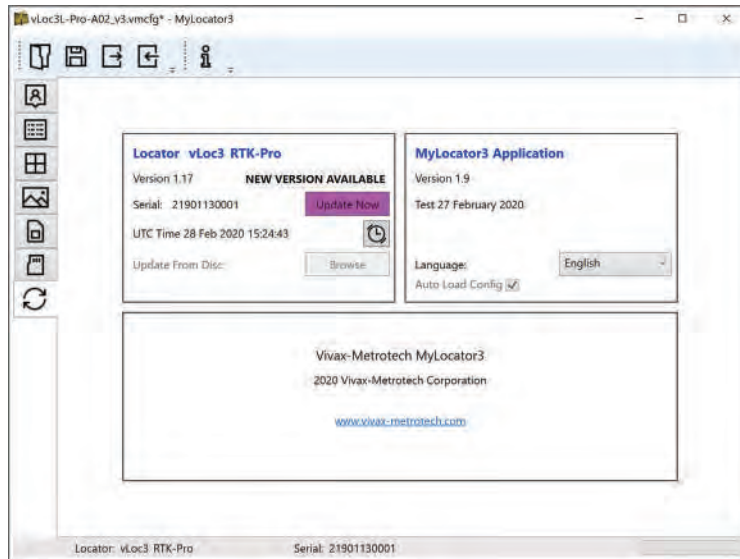



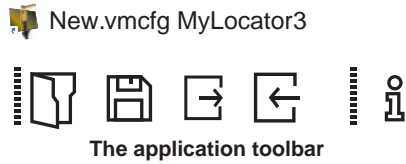

Firmware update notification

4.3.3 Toolbar

The RTK-Pro locator can be configured so that features can be switched on or off. Having this option enables the user to tailor the instrument to meet their needs and keep the user interface uncluttered. The toolbar at the top of the screen enables the user to create configurations.









The application toolbar

	Opens an existing configuration file (*.vmcfg).		Reads the configuration from the connected locator.
	Saves the configuration to a file.		Display information about MyLocator3.
	Write the configuration to the connected locator.		

4.3.4 Feature tabs

The feature tabs run along the side of the display.

	Options such as radio mode frequency band		Cloud (internet) settings
	Menu settings		Datalog
	Frequency selections		Check for updates
	Splash screen		

4.3.5 Data Logging

Clicking on the Data Logging tab will display information about the state of the attached locator's data log contents. The data log contents can be stepped-through by using the controls on the right-hand side. The user can upload a selection of logs from the locator to the PC using the upper right-hand side controls. The data in the data log can be configured before exporting.

The parameters that can be set are:

- Distance units
- Date format
- Time format, i.e., UTC or local time

Files may be exported/saved locally as .csv/.bin/.kml/.shp files and examined later. The default filename is based on the serial number of the connected locator but can be changed during the saving process.



Tip

If it is only required to export a portion of the log (for instance, a survey on a particular day), use the data log scroll facility at the bottom left of the display to scroll through to the start date/time. Note the log number and then scroll to the end date/time and note this log number. Use these numbers to enter the "From" "To" numbers in the display's top right when exporting. Doing so will help to keep the exported data to a manageable size.

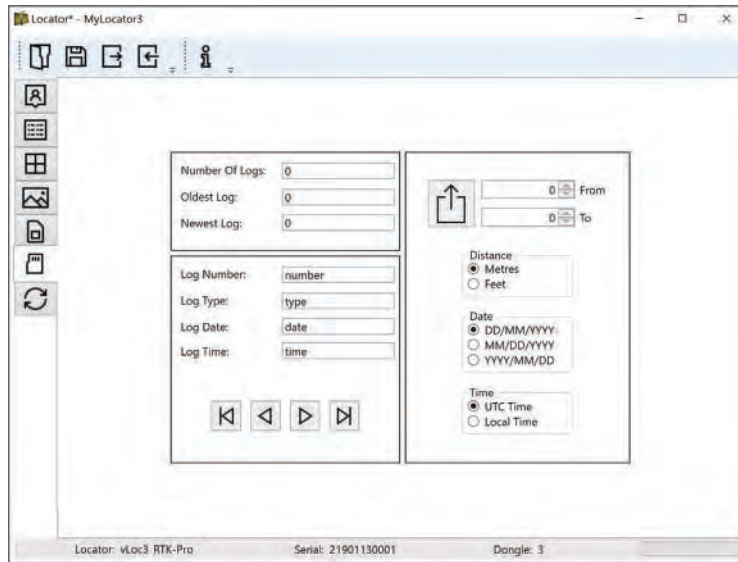

Data Log management screen

Before exporting the data, use the “**Log Type**” dropdown tab to select the type of data required. Options are:

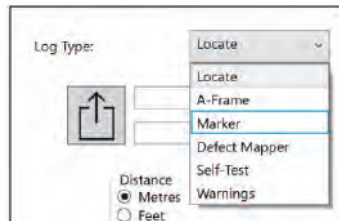

Log Type dropdown list

4.3.6 **Splash Screen**

This option loads an image to be used as a splash screen when the locator is turned on. The locator has an LCD screen with a resolution of 480 by 272 pixels. The image loaded into MyLocator3 will be scaled to fit the width of the screen. If the scaled image height is less than the LCD height, then the image is centered vertically, and white bars are used as padding. If the scaled image height is greater than the LCD height, then the image can be re-positioned vertically by clicking and dragging the left mouse button anywhere on the image.

4 Data Logging

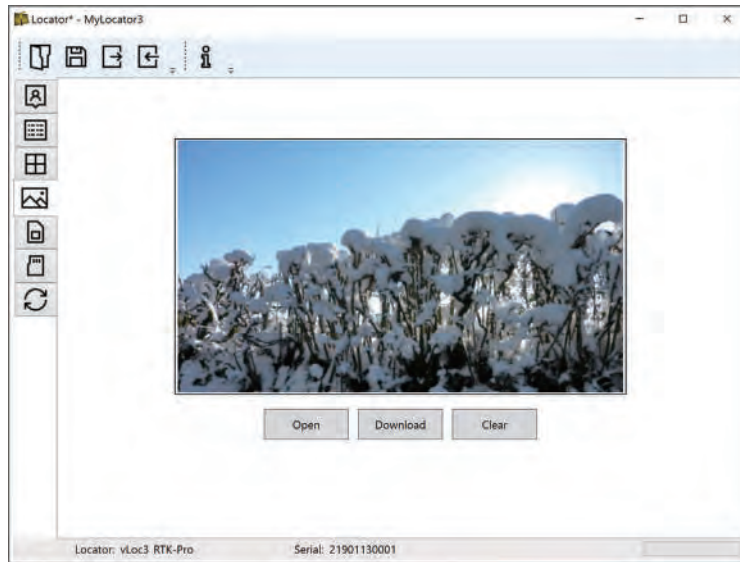

The Splash Screen download area

To create your startup screen, first, click on the “Open” button. Now browse your files to select the picture to use as the start-up screen. The compatible file formats are .jpg, .bmp, .png, and .gif.

The start-up screen will be displayed in the application.

The Download button can be used to set the splash screen immediately, or the image can be sent to the locator along with the rest of the configuration by pressing the Write Configuration button.

To remove a start-up screen and revert to the default Vivax-Metrotech screen, click on the “Clear” button and download the cleared screen.



The default factory loaded splash screen

4.3.7 Frequencies Page

The “Frequencies” page allows the user to select which frequencies and modes are available when the locator's F-key is pressed and which frequencies appear on the locator's menu.

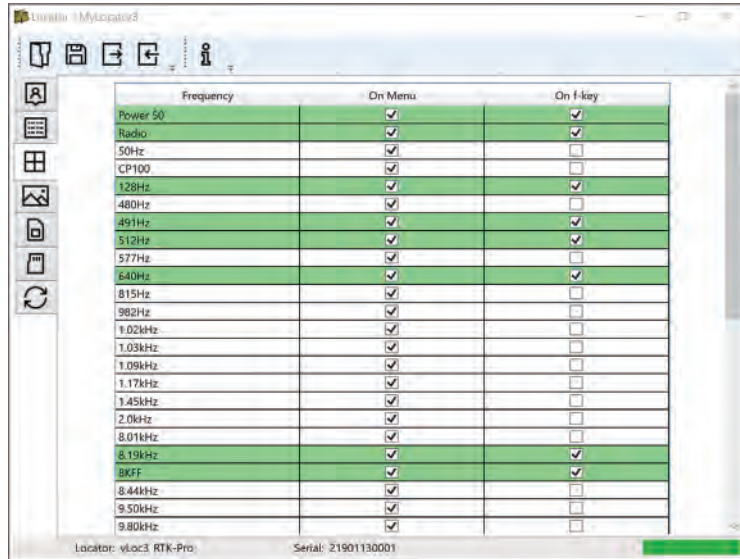

The Frequency page list

4.3.8 Menu Settings

The “Menu Settings” page gives the user control over which menu items appear on the locator and the menu item's initial setting when the locator is first used after configuration.

The menu items with a right-pointing arrow  can be expanded to reveal additional sub-menu items.

If the “On-Menu” item is ticked, then the item will appear on the locator menu. The item displayed in the “Setting” column will be the initial locator setting after configuration. If the “Setting” value is not selected, then the locator setting will be unchanged.

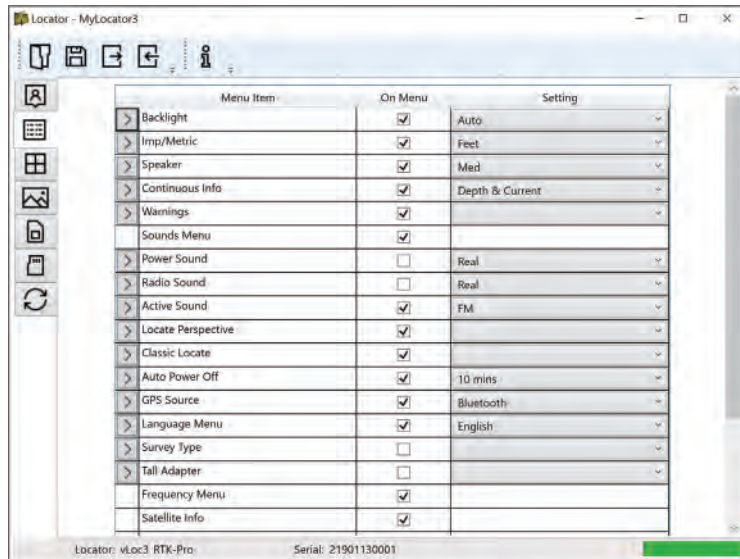

Menu settings

4.3.9 Cloud, Internet and RTK Settings

Click on the Cloud/Internet icon, which allows you to set the cloud settings. A Screen similar to the below will be shown:

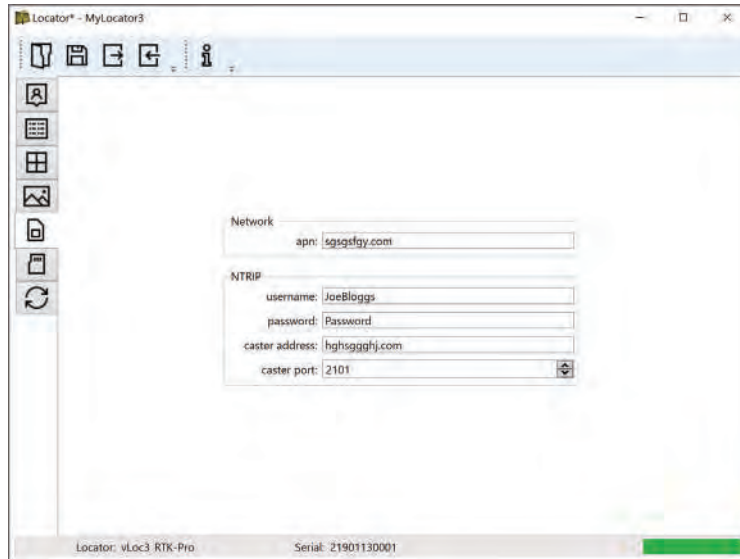

“Network” “apn:” should be adjusted to the Access Point Name for your chosen Mobile network – be sure not to add any spaces before or after the APN. If you do not have the APN, it should be possible to do a quick web search “APN settings for a mobile network.”

“NTRIP” settings should match your preferred NTRIP caster settings. If you have subscribed to an RTK provider, they will give you your Caster address, caster port, Username, and password.

Click on the  icon on the toolbar to send the settings to the locator.

4.3.10 Advanced Features

The Advanced Features are available to those users in possession of a USB security dongle. If a dongle is attached to the PC, its level will be displayed on the MyLocator3 status bar.

Three levels of security come with the dongle. Level one is for the end-user supervisors, level two for Vivax-Metrotech's distributors, repair centers, managers, and level three for Vivax-Metrotech use only.

4.3.10.1 Supervisor Lockouts

This feature is available to anyone with a dongle (contact Vivax-Metrotech to purchase a dongle). When a dongle is connected to your computer via a standard USB socket, the icons for the “Splash Screen” page, “Frequencies” page and the “Menu Settings” page will change color to green. This color indicates the page is unlocked.

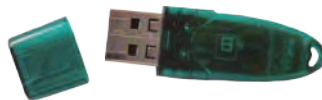

Levels of Dongle security

1. End-user supervisors
2. Vivax-Metrotech distributors, repair centers, and managers

The Splash Screen page, Frequencies page, and Menu Settings page can be individually locked by double-clicking on their page tab icon. If a page is locked, a user can only access it with an appropriate security dongle. Doing so will prevent unauthorized users from changing protected locator items. i.e., the “Splash Screen” can be locked to prevent the user from changing it.

The page tab icon will change color from green to amber.

To unlock a tab with the dongle connected, double click on the tab to unlock.

5. The Loc3 Series Transmitters

This section of the manual covers the 5-watt, 10-watt and 25-watt Transmitter.

5.1 Loc3 Series Transmitter Overview

The Loc3 series transmitters are rugged portable transmitters powered by Li-ion rechargeable li-ion batteries or alkaline "D" cells.

5 and 10-Watt Transmitters



1	Loc3 series transmitter
2	Ground stake
3	Direct connection lead
4	D cell alkaline batteries 5-watt = x 8, 10-watt = x 12
5	Alkaline battery tray
6	Mini-USB lead

25-Watt Transmitter



1	Loc3-25Tx Transmitter
2	Li-ion battery tray
3	Carry bag
4	AC/DC Adapter, Loc3-25Tx
5	Direct connection lead, Loc3-25Tx
6	Ground stake
7	Mini-USB lead

5.2 The Transmitter Display

5 and 10-Watt Transmitter Display

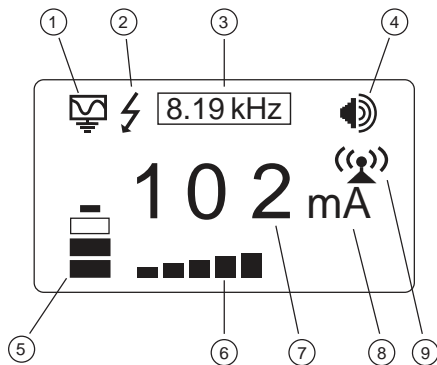

1	Mode indication icon	6	Output step bar graph
2	High Voltage Warning*	7	Digital readout (mA, volts, ohms)
3	Active frequency	8	Units (mA, volts, ohms)
4	Speaker level	9	Tx-Link Status Blinking icon = Tx-Link is not paired Solid icon = Tx-Link is active and linked to the transmitter
5	Battery status		

25-Watt Transmitter Display

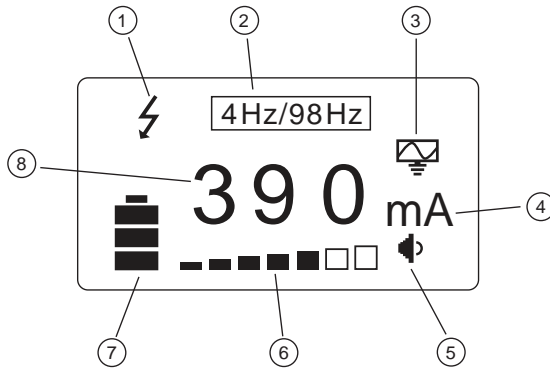

1	High Voltage Warning*
2	Active frequency
3	Mode indication icon
4	Units (mA, volts, ohms)
5	Speaker level
6	Output step bar graph
7	Battery level or DC Input icon
8	Digital readout (mA, volts, ohms)

***Output Protect Warning**

The transmitter checks the line when connected. Output protected against accidental momentary connection to up to 230V AC (RMS) will display the “high voltage” warning icon and not allow the transmitter to operate. A 1.6A/250V fuse protects the 5-watt and 10-watt transmitters. A 4A/250V fuse protects the 25-watt transmitter. Fuses protect both in the event of excessive voltage spikes on the line.

5.3 Pushbuttons

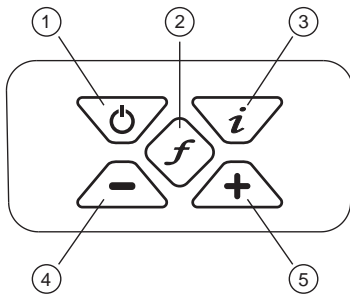

1	On/Off button
2	Frequency selector
3	Information (Volume, Volts, Ohms, Multi-frequencies LCD Contrast, Receiver Link, Frequency menu and About screen)
4	Output decrease/Navigate through the menu
5	Output increase/Navigate through the menu

5.3.1 Transmitter Information Pushbuttons

Press the <i>i</i> button to access the transmitter settings and menu.	
Use the + and – buttons to navigate the settings and menus.	
Use the <i>f</i> button to make selections. An X will appear for selected items.	

5 and 10-Watt Transmitter Menu Structure

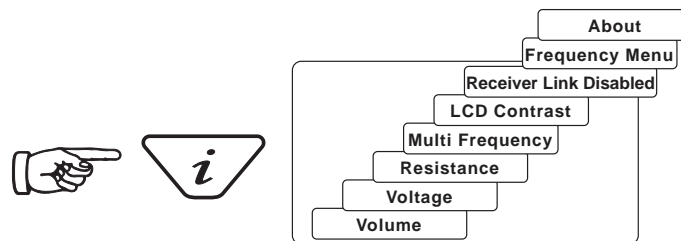

25-Watt Transmitter Menu Structure

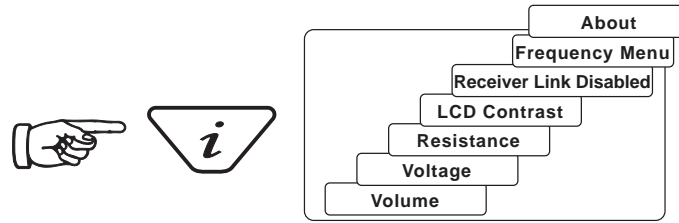

When the “i” (information) pushbutton is pressed, the display will show the volume level. Use the + and - pushbuttons to increase, reduce or turn the speaker off. (off-low-medium-high).

Keep pressing the “i” (information) pushbutton, and the display can be toggled to show “voltage,” “resistance,” or other functions, as shown in the drawing above. The display indicates mA as the default and volts or ohms when selected.



NOTE
The number of “i” button presses and available sub-menus will vary with the transmitter's mode.

5.3.2 Transmitter Connections Block

5-Watt and 10-Watt Connection Block

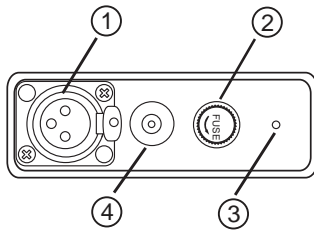

1	Output connection, 3-pin XLR
2	Fuse holder - Output protection (1.6A/250V Fuse)
3	Speaker
4	Battery charging & DC input socket

25-Watt Connection Block

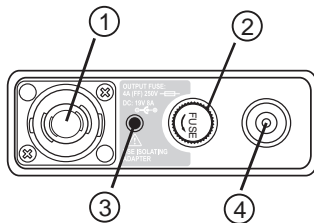

1	Output connection, speakON®
2	Fuse holder - Output protection (4A/250V Fuse)
3	Speaker
4	Battery charging & DC input socket

All connections to the transmitter are made through the connection block.

5.4 Transmitter Batteries – Li-ion and Alkaline

5 and 10-Watt Transmitters - The 5-watt transmitter uses 8 x D cell alkaline batteries, while the 10-watt uses 12 x D cells.

25-Watt Transmitter - The 25-watt transmitter ships with a custom Li-ion battery tray with a charger and power cable. An optional 12 X D Cell Alkaline battery tray can be used with the 25-watt transmitter, but the output will be limited to 10-watts.

On all transmitters, the battery status is shown on the transmitter's LCD. The letters “LP” will appear when the battery status reaches only one bar. At this battery level, the max output current and power are limited.

The LED on the charger will show a red light indicating that the charge cycle is in progress. When the batteries are fully charged, the LED will change to green.

Follow instructions detailed in the General Safety & Care Information section of this document. Dispose of batteries following your company's practice and environmental standards, the prevailing laws, or recognized best practice. Always dispose of batteries responsibly.



NOTE

The 25-watt transmitter ships with the Li-ion battery tray. An optional alkaline tray can be used with the 25-watt transmitter, but the power output will be limited to 10-watts.



WARNING

Use only Vivax-Metrotech recommended charger.
Do not attempt to replace the rechargeable batteries or remove battery covers.
Return to Vivax-Metrotech or a Vivax-Metrotech approved service center for replacement.

5.5 Charging the Transmitter Battery Tray

The rechargeable battery tray can be charged while attached to the transmitter or on its own. The battery condition (status) is displayed on the transmitter's display.

1. Connect the charger to the charging socket on the transmitter's side or directly into the battery tray's charging socket.
2. The LED on the charger will glow red while charging and turn green when fully charged.

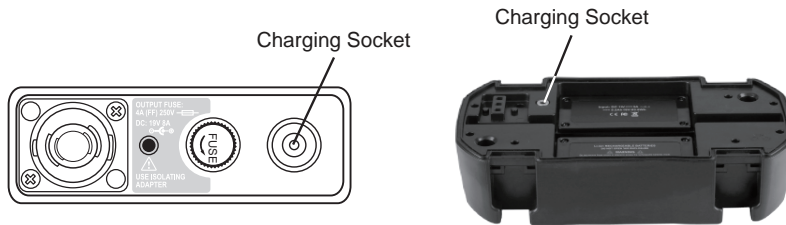

Plug the charger into the charging socket on the side of the transmitter or directly into the battery tray

Battery Charger - is supplied as standard equipment with the 25-watt transmitter.



Battery Charger - is supplied with the optional Li-ion battery tray.



Optional 12-volt DC Power Lead - this 30ft/90m lead can be used to power the transmitter when connected to a target line at high output levels for extended periods. It will not charge the transmitter battery.



WARNING

Only use a charger supplied by Vivax-Metrotech Corp. Using non-approved chargers may result in damage to the equipment or overheating/explosion.



NOTE

The rechargeable tray cannot be charged from a 12V DC source.

Follow instructions detailed in the General Safety & Care Information section of this manual. Only use the battery charger supplied as using an unapproved charger may damage the battery pack and may cause overheating.

5.6 Removing and Installing the Battery Tray

These procedures apply to both the Alkaline or Rechargeable battery tray.

Removing the battery tray



1. Reach under the catch and pull to unlock.



2. Lift the catch and repeat for all four catches.



3. Lift the transmitter base from the battery tray.

Installing the battery tray



The battery tray and transmitter base have a matching aligning post, contact pins and socket.



1. Align the aligning post and lower the transmitter base into the battery tray.



2. Press down on the locking catch until it locks in place. Repeat and lock all four latches.

Aligning the post in their receptacles will assure that the contact pin will mate and not be damaged.

5.7 Transmitter Modes



WARNING

Always connect the transmitter to the target line following your company's procedures. These operations should only be performed by authorized personnel. Always make connections before switching on the unit. Turn the transmitter off before disconnecting.



NOTE

When the 25-watt transmitter is powered on without connection leads a "NO CONNECTION" message will appear on the LCD. Power off the transmitter and insert the connection leads, and proceed with power up.

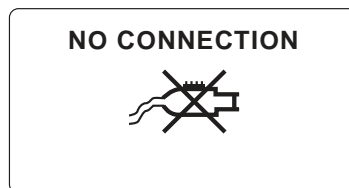

25-Watt Transmitter (Only)

5.7.1 Direct Connection Mode

The **Direct Connection** mode is automatically selected by plugging a connection lead into the output socket. An icon confirming the direct connection mode is shown on the display. The wave in the icon fluctuates when the transmitter is operating. The direct connection lead consists of two colored cables with clips and covers. The red clip must be connected to the conductor being located, the black clip to a suitable ground such as the ground stake provided with the transmitter.

A good connection is indicated by a change in the beep rate from the speaker and the current reading on the display.

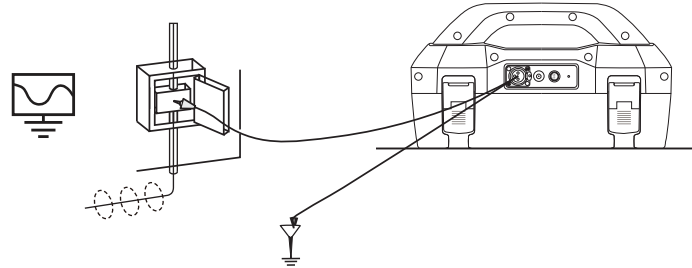

Wherever a direct connection can be safely made without the risk of injury, damage to the customer's plant, or the transmitter, it is the best way of applying the transmitter's signal.

The positioning of the ground connection can also influence the degree of coupling experienced. Ground connections generally should not be made to other pipes or cables or above-ground metallic structures such as wire fences. In general, the lower the frequency is, the further the signal will travel, and the less signal-coupling will occur. The most common frequencies used for direct connection are between 512Hz/640Hz and 8kHz.

Regulations in many countries require that power output is limited above specific frequencies. The Loc3 series 5-watt, 10-watt, and 25-watt transmitters enable frequencies below 45kHz to be transmitted using as much as 5-watts, 10-watts or 25-watt output, depending on your transmitter, but frequencies over 45kHz are restricted to 1-watt. Using direct connection and the higher power at the low frequencies helps significantly in achieving greater location distances. Direct connections should not be made to cables carrying greater than 25V (or as your safety practices allow). The transmitter is protected (250V fuse) from stray currents that may exist on the target line.

5.7.2 Clamp Mode

The transmitter signal clamp is a precise way to apply the locate signal. Clamps are generally used when it is impossible to access the conductor to make a direct connection, but there is access to place the clamp around the cable. Clamps are also used when it is not safe to connect because the target cable is live carrying electricity.

The clamp is a specialized inductive device (sometimes known as a toroid or coupler). All clamps are optimized to work at specific frequencies. In most cases, clamps are designed for use at frequencies between 8kHz and 200kHz (between 8kHz and 9.82kHz for the 25-watt transmitter). The transmitter will only allow the selection of a suitable range of frequencies for your clamp.

Plugging a Vivax-Metrotech clamp into the output socket will place the transmitter into the "Clamp" mode. An icon confirming this is shown on the display and will flash when the transmitter is transmitting.

When using the clamp, no ground connection is needed.

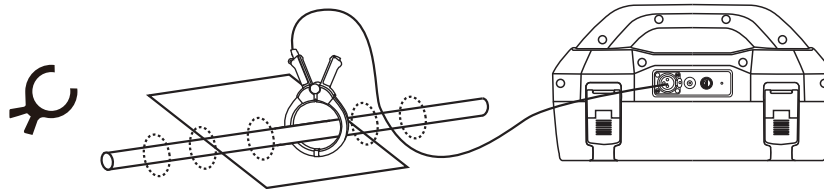

WARNING

When applying the clamp to cables that carry electricity – be sure to follow your company's safety instructions and procedures. Beware that if applied around a high voltage cable – that cable may induce a current in the clamp, causing it to snap shut or jump quite dramatically – always apply clamps carefully.

5.7.3 Induction Mode – 5-Watt and 10-Watt Transmitters Only

The 5-watt and 10-watt transmitters use an internal antenna to induce a locating frequency onto the target utility. The Induction mode is automatically selected if no connection accessories are plugged into the “output socket.” An icon indicating the “Induction” mode will show on the display. The icon flashes when the transmitter is transmitting. The transmitter should be positioned over and with the handle in line with the target line to generate successful induction.

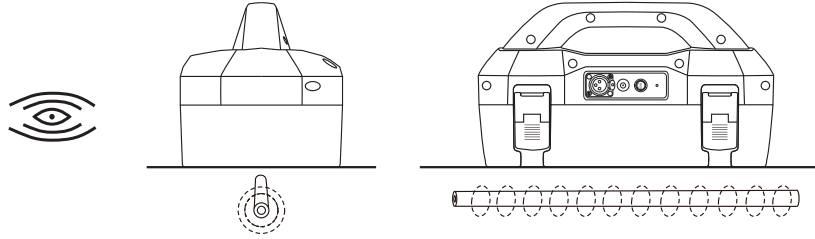

“Induction” mode is generally used when no access is available to make a direct connection or a clamp connection. When using induction, likely, the signal being induced onto the target line will also be induced onto other lines in the area and onto above-ground features such as wire fences. This can influence the accuracy of the location, depth, and current measurements. “Induction” mode is also the least efficient way of applying the transmitting signal to the target line. The distance located with the “Induction” mode is generally much less than that achieved with a direct connection or clamp connection. The “Induction” mode is only available from 8kHz and above.

Induction frequencies are available based on the user selection. See section 5.8.2 for information relating to the “Most Used Frequencies (Frequency Selection) Feature” to add and remove frequencies from the favorite frequencies list.



NOTE
For accurate location and depth measurement, the locator receiver should be used no closer than 66ft (20m) from the transmitter.

5.8 Transmitter Frequencies

The Loc3 series transmitters are supplied with a predefined set of transmitting frequencies. The factory will preset the most commonly used frequencies. Additional frequencies are available to be selected in the frequencies list; see section 5.8.2.

5.8.1 Frequencies and Maximum Power Output

5-Watt and 10-Watt Transmitters

Frequencies power outputs	Loc3-5Tx	Loc3-10Tx
Direct connection 10-watt:	-	98Hz-45kHz
Direct connection 5-watt:	98Hz-45kHz	-
Direct connection 1-watt:	>45kHz-200kHz	>45kHz- 200kHz

Clamp Connection: Available frequencies between 8.19 kHz and 200 kHz

Induction Frequency: Multiple induction frequencies between 8.19kHz and 200kHz

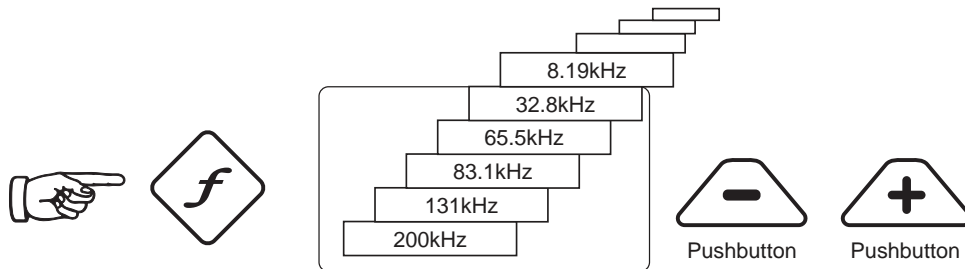

25-Watt Transmitter

Frequencies power outputs

Direct connection 25-watt:

Loc3-25Tx

32Hz - 9.82kHz

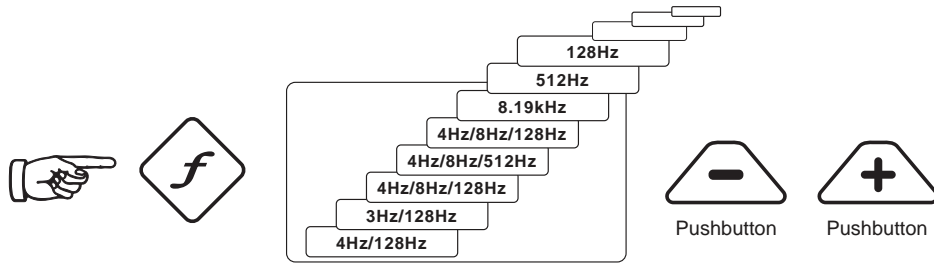

As with most manufacturers, signal clamps are tuned to specific frequencies and **will not** work over the complete range of frequencies

Frequencies are selected by pressing the “f” pushbutton, which toggles through the frequencies available in the current mode's available frequencies. The frequency is automatically selected if you don't toggle past it within two seconds.

NOTE



The output current is shown in large characters on the display. To increase or reduce the current output, press “+” or “-” The vertical bar graph at the bottom of the display indicates which of the seven current output steps is being used. If the transmitter can supply the requested current, the bar will turn black. If the bar does not turn black, improving the ground connections or wetting the ground where the earth stake is positioned may help. However, it may not achieve the current setting requested because the line's impedance is too high for this setting. If this happens, it is best to select a lower setting with a black bar, ensuring a stable output.

The impedance of the target line will limit the current being transmitted; therefore, it is not unusual to increase the output level but see no increase in the currently displayed. This is not a fault with the transmitter.

The transmitter will always revert to first-level output when switched on as a power-saving feature. In most circumstances, this output level is sufficient. Increasing the output power unnecessarily will reduce battery life. All other settings remain the same as the last setting used.

5.8.2 Most Used Frequencies (Frequency Selection) Feature

This feature allows the operator to choose the most used frequencies from a list of frequencies. Once these frequencies are selected in the main menu, the user can scroll through them by pressing the “f” pushbutton. The user can add or remove frequencies from the above list by following the below procedure. The maximum number of frequencies that can be activated in the most used frequencies list is 12.

The advantage of this feature is the user can work with only their preferred frequencies rather than having a more extensive list of frequencies to scroll through.

Enter the Frequency Menu:

1. Press the “i” pushbutton four to six times (based on the mode that the transmitter is in) until reaching the “Frequency menu” sub-menu.

In Direct Connection mode

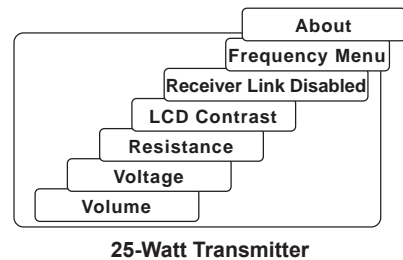
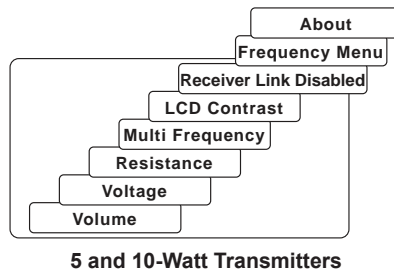

5 The Loc3 Series Transmitters

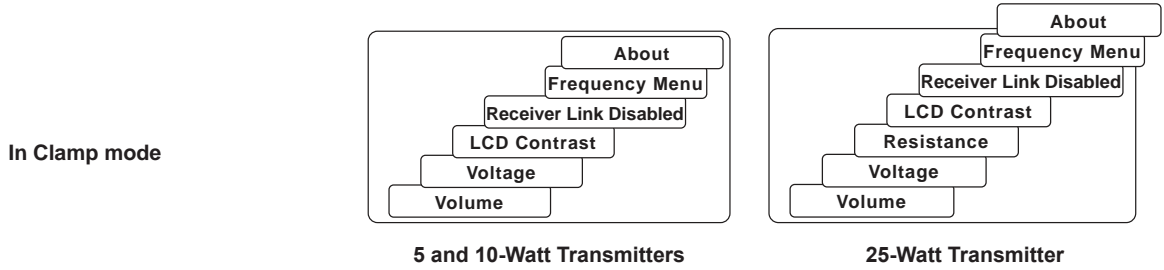
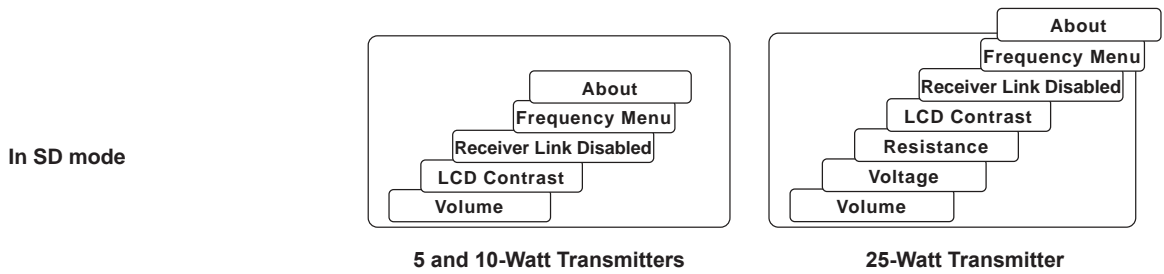

2. The screen will show a list of frequencies available, with the central one in a box

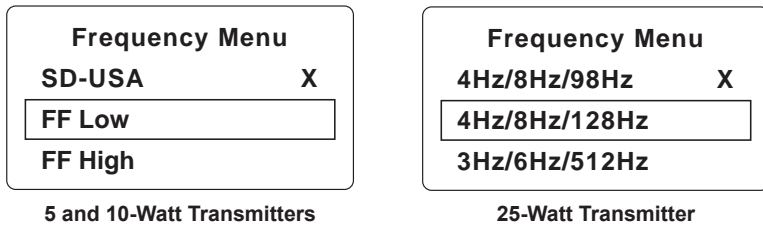

3. Pressing the “+” or “-” pushbuttons, you can scroll up or down through the available frequencies.

4. Once the wanted frequency is inside the box, press the “f” pushbutton to select or deselect the frequency. An “x” will appear in the box for a selected frequency.

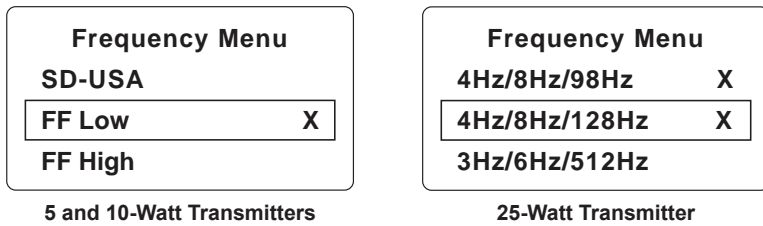

5. After selecting the frequencies press the “i” pushbutton again to exit the “Frequency Menu” and return to the main display.
6. A particular frequency in the chosen list of frequencies can be selected from the screen by pressing the “f” pushbutton until the wanted frequency is displayed at the top of the main screen.

5.8.3 Multi-Frequency Mode for Direct Connection

This feature can be used to energize two or three frequencies simultaneously on the target line. This is especially helpful when the user is unsure which frequency is best to apply to the target line.



NOTE

- When using the multi-frequency mode total power will be split between the activated frequencies.
- The multi-frequency mode is not available in Fault Find and SD modes.
- The frequencies have to be available in the main menu.

Enter the Multi-frequency Setup menu:

1. Press the “i” pushbutton seven times to get to the “Multi-Frequency” screen and press the “f” pushbutton to activate the multi-frequency mode. An “x” symbol will appear indicating that the multi-frequency mode is activated. Press the “f” pushbutton again to go to the “Multi-Frequency. Setup” screen to choose the frequencies.
2. Use the “+” and “-” pushbuttons to scroll through the available frequencies and add the desired frequency in the first box
3. Press the “f” pushbutton to move the box down and the “+” and “-” pushbuttons to select the second frequency.
4. Repeat step three to select the third frequency if needed.
5. Press the “i” pushbutton to return to the main display. On the main display, “Multi” will appear, indicating the multi-frequency mode is active.
6. The frequencies selected for multi-frequency mode will be saved until changes are made even when the multi-frequency mode is deactivated.

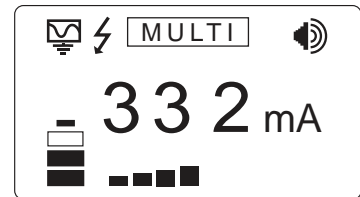
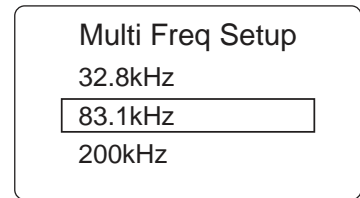
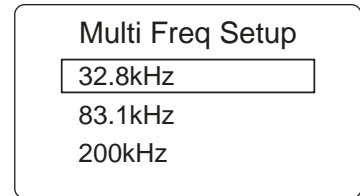
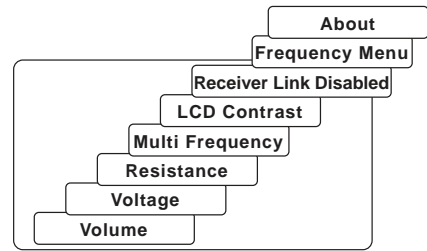

5.9 Transmitter Link (TX-Link) 

Currently, the Tx-Link feature is **only available in the 5-watt and 10-watt transmitters.**

The Loc3 series transmitters can be remotely operated from the receiver. This option requires the Transmitter (radio) Link to be installed in both the vLoc3 series receiver and the Loc3 series transmitter.

Tx-Link is a factory fit option that must be purchased at the time of ordering. The radio link range depends on having a clear “line of sight” between Rx and Tx but is typically around 300m (984ft).

The Tx-Link feature is shown as RECEIVER LINK in the menu.

Linking a transmitter to a receiver:

1. Press the “i” button repeatedly to scroll through the options until the “RECEIVER LINK DISABLED” option is displayed.



5 The Loc3 Series Transmitters

2. Press the "+" key to enter the Receiver Link menu.
Press the "+" or "-" key to highlight the "ENABLE" option, then press the "F" key to start the process. The display will show the message "WAIT" until the setup is complete.

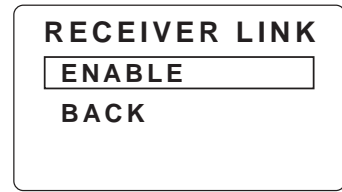

3. An ID number will now be displayed at the bottom of the screen for identification purposes.

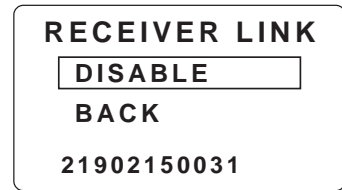

4. The transmitter is now waiting to connect to a receiver.
Either press the "I" button or use the "+" and "-" keys to highlight "BACK" then the "F" key to exit back to the main screen.

When on the main screen, a "beacon" icon will be displayed on the right-hand side. When the icon is flashing, the transmitter is waiting to connect to a receiver. The flashing will stop when successfully connected to the receiver. If no icon is visible, this indicates that the Receiver Radio Link has not been activated.



5. While the icon on the transmitter is flashing (indicating that it is waiting to connect to a receiver), switch on the vLoc3 series receiver and enter the user menu by pressing and holding the information button. Scroll down the menu options until Transmitter Link is highlighted.

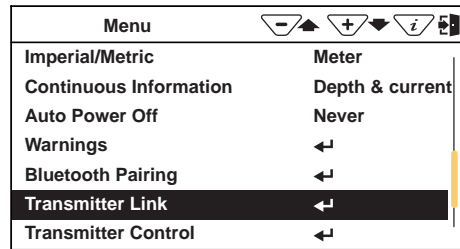

Note that the order of enabling the transmitter or receiver radio links does not matter.

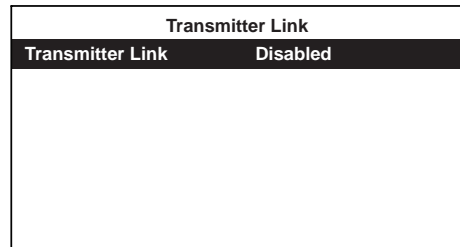

6. Select the "Transmitter Link." Check that the radio module is enabled. If not, press the return button to enable the Transmitter Link. After a short scan, the available devices will be displayed. Highlight the one to be selected and press the return button. Press the information button to return to the main menu.

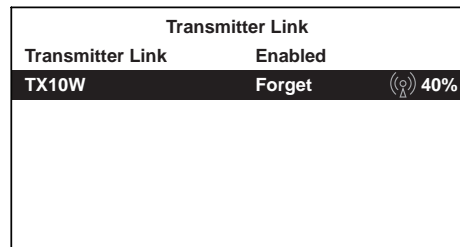

7. The "Beacon" icon on the transmitter should not be flashing anymore at this point. A solid icon indicates that the link has been established.

5 The Loc3 Series Transmitters

8. From the main menu, select the “Transmitter Control” option. (that will become visible when the two devices are linked)
A screen similar to the below should be seen:

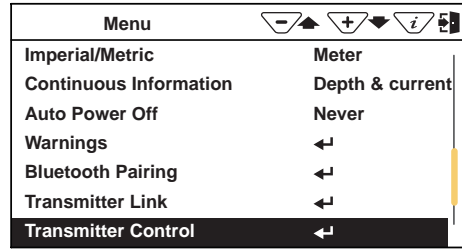

From this screen, if the link status shows “Connected,” it is possible to:
a. Alter the output level of the transmitter using the “+” and “-” buttons.
b. Alter the transmit frequency using the “f” button.

Also shown is the:

- Radio link signal strength, in this case, 40%.
- Output mode, in this case, direct connection.
- Output current, in this case, 100mA.
- Beeper volume setting, in this case, level 2.
- Transmitter battery level.

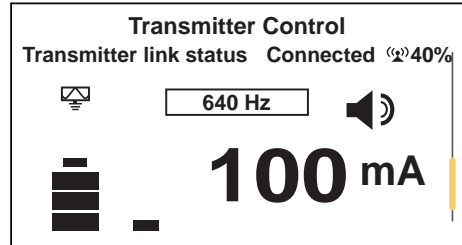

Use the Information button to navigate/exit back to the locate screen.
When in the Locate screen, the status of the link is displayed in the Status bar.



The various indications of the status are listed below:

	No radio module or it is disabled (Always disable in the User Menu when not in use)
	No link and no signal
	No link and poor signal
	No link but good signal
	Is linked to the transmitter but the signal is poor
	Is linked to the transmitter with a good signal

TIP



While the Transmitter and Receiver are linked, changing the Receiver Frequency will automatically result in a similar change to the Transmitter frequency, so there is no need to re-enter the menu screen to change the Transmitter frequency remotely. The Frequency indicator will flash when resetting or if an invalid frequency is requested.

If the Tx/Rx Radio link is not being used, make sure the receiver’s link is set to “Disabled” on both RX and TX. The radio link will continue to search for the transmitter or receiver that may interfere with the Bluetooth operation. Also, disabling when not in use will conserve battery charge.

6. Accessories & Options

6.1 Transmitter Signal Clamps



Clamps are accessories used to apply the transmitter signal to an insulated line, removing the need to connect the transmitter signal directly to a conductor or cable sheath.

Sizes

5-Watt and 10-Watt Transmitters: 2-inch (50mm), 4-inch (100mm), 5-inch (125mm) and 18-inch (45cm) flexible version.

25-Watt Transmitter: 4-inch (100mm) and 5-inch (125mm).

6.2 A-Frame Fault Locator



The A-frame accessory is used to detect ground faults on pipes and cables. In the case of pipes, the faults consist of coating defects. In cables, faults are usually caused by insulation damage allowing the metallic sheath (or internal conductor) to contact the earth.

6.3 vLoc3-MLA (Marker Locator Adapter)





The vLoc3-MLA (Marker Locator Adapter) is designed for easy, fast, and accurate location of buried EMS markers. Once located, the MLA will give the depth of cover to the buried marker with the touch of a button.

The MLA attaches to the bottom of vLoc3-Pro, RTK-Pro, vLoc3-9800, and vLoc3-5000 receivers. When attached and plugged into the receivers, two marker related operating modes are enabled.

Visit us at www.vxmt.com to see the full range of receiver and transmitter accessories and available options.

7. Glossary

Active Locate	A locate where a transmitter is used to apply a signal to a buried pipe or cable, which is then located by a receiver tuned to the same frequency.
Active Signal	A signal is applied by the locator transmitter to a buried line. Typical, this is a very precise frequency.
Attenuation	The reduction of an electromagnetic signal from a pipe or cable.
Clamp (or Coupler)	An accessory used to apply the transmitter signal to an insulated line, removing the need to connect the transmitter signal directly to a conductor or cable sheath.
Compass	Line direction indicator. (Although visually like a compass, this is the only relation to a compass.)
Coupling	The act of signals transferring to lines to which they were not originally applied. The coupling can be "direct" where the target line has an electrical connection to another line or "induced," where the signal radiates from the target line to another line or lines.
Datalog	Refers to data stored in the memory of the vLoc3 Locator.
Display	The information visually available on the dot matrix display.
Firmware	Permanent software programmed into the vLoc3 read-only memory.
.kml File	Keynote Markup Language (KML) is a file format used to display geographic data in an Earth browser such as Google Earth, Google Maps, and Google Maps.
Line	A generic term for any buried pipe or cable.
Null	A minimum  response to a buried line.
MyLocator3	App created to manage software updates and datalog transfers associated with the vLoc3 range of cable locators.
Passive Locate	A locate where the receiver searches for a wide range of signals that radiate from buried pipes or cables. These signals come from various sources in the environment and couple to the buried (& overhead) lines. Typical examples 50/60Hz and LF/VLF radio.
Passive Signals	A wide range of signals radiates from buried pipes or cables. These signals come from various sources in the environment and couple to the buried (& overhead) lines. Typical examples 50/60Hz and LF/VLF radio.
Peak	Maximum response to a buried line. 
Pinpoint	Using a receiver to identify the exact position of a buried line.
Response	The indication that the receiver gives is caused by the signals it is receiving. This can be visual, audio, or both. Typically, it is displayed on the locator's dot matrix display and audibly from a loudspeaker in the receiver housing.
Search (sweep)	This describes the act of looking for a buried line within a given area.
shapefile	The shapefile is a grouping of several files formatted to represent different aspects of geodata: <ul style="list-style-type: none"> • .shp — shape format; the feature geometry itself. • .shx — shape index format; a positional index of the feature geometry to quickly seek forward and backward. • .dbf — attribute format; columnar attributes for each shape, in dBase IV format.
Sonde	A small transmitting coil may be built into a product such as a sewer camera or packaged as a small self-contained battery-powered transmitter. A receiver tuned to the same frequency can locate the Sonde's position and hence whatever it is attached to or in. Frequently used for locating sewer cameras and non-metallic pipes.
Target Line	The buried pipe or cable to be located.
.txt Text File	A .txt file is a standard text document that contains the unformatted text.
Trace	Using a locator to follow the path of a buried line.

Illustrations used in this manual's preparation will inevitably show some resemblance to similar illustrations from other manufacturers. These manufacturers have permitted the use of their graphics. This statement is intended to attribute such credit.

The Bluetooth® word mark and logos are registered trademarks owned by the Bluetooth SIG, Inc.

iOS is a trademark of Cisco Systems, Inc., registered in the U.S.

Android, Google and Google Maps are registered trademarks of Google LLC.

Disclaimer: Product and accessory specification and availability information are subject to change without prior notice.

