

PHANTOM 4 RTK

User Manual v2.6

2023.09

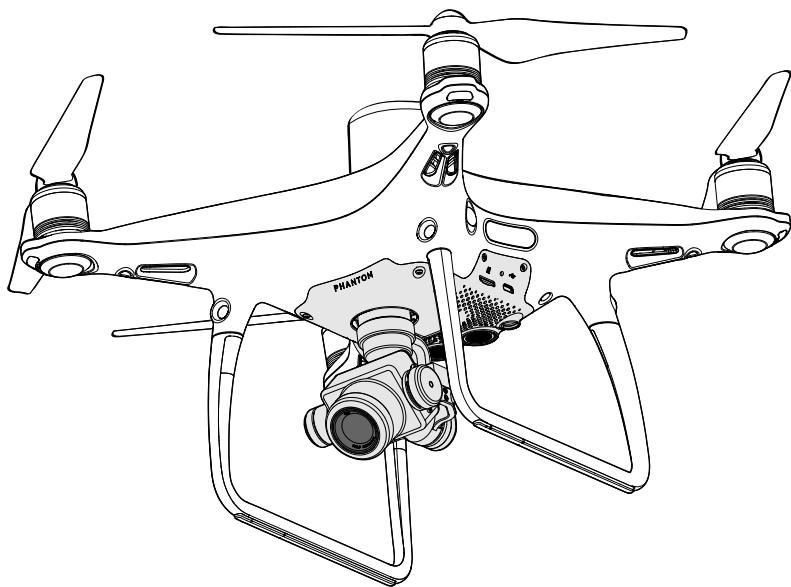

Searching for Keywords

Search for keywords such as “battery” and “install” to find a topic. If you are using Adobe Acrobat Reader to read this document, press Ctrl+F on Windows or Command+F on Mac to begin a search.

Navigating to a Topic

View a complete list of topics in the table of contents. Click on a topic to navigate to that section.

Printing this Document

This document supports high resolution printing.

Revision Log

Version	Date	Revision
v2.4	2021.07	Added instructions to update the firmware of the remote controller (P70, P75).
v2.6	2023.09	Added FAR Remote ID compliance information (P78).

Information

There are two kinds of altitudes displayed in the DJI GS RTK app, absolute altitude and relative altitude.

Absolute altitude: The geographical attribute, in relation to longitude and latitude.

Relative altitude: The altitude data of the operation tasks relative to the Home Point. In the same operation, the absolute altitude for the same point during the operation will vary when taking off from locations with different elevations.

Using this manual

Legends

⚠ Warning

⚠ Important

💡 Hints and Tips

📖 Reference

Read Before the First Flight

Read the following documents before using the PHANTOM™ 4 RTK:

1. In the Box
2. User Manual
3. Quick Start Guide
4. Disclaimer and Safety Guidelines
5. Intelligent Flight Battery Safety Guidelines

We recommend that you watch all tutorial videos on the official DJI™ website and read the Disclaimer and Safety Guidelines before you fly. Prepare for your first flight by reviewing the Quick Start Guide and refer to the User Manual for more details.

Watch the Tutorial Videos

Please watch the tutorial videos at the link below, which demonstrates how to use the Phantom 4 RTK safely: <http://www.dji.com/product/phantom-4-rtk/info#video>



Download the DJI Assistant 2 for Phantom

Download DJI ASSISTANT™ 2 for Phantom from: <http://www.dji.com/phantom-4-rtk/info#downloads>

⚠ The operating temperature of this product is 0° to 40° C. It does not meet the standard operating temperature for military grade application (-55° to 125° C), which is required to endure greater environmental variability. Operate the product appropriately and only for applications that it meets the operating temperature range requirements of that grade.

Contents

Information	2
Using this manual	2
Legends	2
Read Before the First Flight	2
Watch the Tutorial Videos	2
Download the DJI Assistant 2 for Phantom	2
Product Profile	6
Introduction	6
Features Highlights	6
Installation	6
Aircraft Overview	9
Remote Controller Overview	10
Aircraft	13
Profile	13
Flight Modes	13
Aircraft Status Indicators	14
Return to Home (RTH)	15
Industrial Applications	20
Vision System and Infrared Sensing System	30
RTK Functions	33
Flight Recorder	35
Attaching and Detaching the Propellers	35
DJI Intelligent Flight Battery	36
Remote Controller	42
Profile	42
Using the Remote Controller	42
Remote Controller Status LED	46
Linking the Remote Controller	47
Multi-Aircraft Control Function	48
Gimbal and Camera	51
Camera	51
Gimbal	53

DJI GS RTK App	55
Main Screen	55
Planning View	56
Camera View	58
Cloud PPK Service	60
Flight	64
Flight Environment Requirements	64
GEO (Geospatial Environment Online) System	64
Flight Restrictions	65
GEO Unlocking	67
Calibrating the Compass	68
Preflight Checklist	68
Starting/Stopping the Motors	69
Stopping Motors Mid-flight	69
Flight Test	70
DJI Assistant 2 for Phantom	72
Installation and Launching	72
Using DJI Assistant 2 for Phantom	72
Appendix	74
Specifications	74
Updating the Firmware	77
FAR Remote ID Compliance Information	78

Product Profile

This section introduces the Phantom 4 RTK and lists the components of the aircraft and remote controller.

Product Profile

Introduction

The Phantom 4 RTK is a smart mapping and imaging drone capable of highly accurate mapping functions. The aircraft has a built-in DJI Onboard D-RTK™, which provides precision data for centimeter-level positioning accuracy*. Multi-directional obstacle sensing achieved through vision and infrared sensors enables intelligent obstacle avoidance during flight and indoor hovering and flight. The Phantom 4 RTK records videos at 4K and captures 20 megapixel photos. The Ocusync™ HD video downlink built into both the aircraft and remote controller ensures a reliable and stable transmission.

Features Highlights

The Phantom 4 RTK aircraft has a built-in DJI Onboard D-RTK, providing high-precision data for centimeter-level positioning when used with Network RTK service or a DJI D-RTK 2. Raw satellite observations and exposure event records can be used for post-processed kinematic (PPK) differential corrections.

The Phantom 4 RTK can hover and fly in extremely low altitude and indoor environments, and provides multi-directional obstacle sensing and vision positioning functions. Obstacles detection and avoidance in large range and landing protection enhance flight safety.

The Phantom 4 RTK is equipped with a 24 mm (35 mm format equivalent) wide angle camera, high-precision and anti-shake gimbal, 1-inch CMOS sensor, mechanical shutter to offer the best in aerial photo analysis.

Built into the remote controller is the latest DJI OcuSync technology with enhanced anti-interference capability to deliver a more stable and smoother video downlink. When combined with the receiver in the aircraft, the remote controller has a transmission range up to 4.3 mi / 7 km (FCC-compliant version). The remote controller is equipped with a 5.5-inch high luminance monitor, and an integrated DJI GS RTK App for real-time HD display. Users can plan flight paths and perform flight operations in the app for operation types of Photogrammetry, Waypoint Flight, Linear Flight, Terrain Awareness Mode, Block Segmentation, Linear Flight (Adjustable Height), and Angled Flight Route. For Photogrammetry, Linear Flight, Terrain Awareness Mode, and Block Segmentation operations, simply tap on the map in the app or import files to set a flight area. For waypoint operations, fly the aircraft to set waypoints and configure waypoint actions, then the aircraft will be able to perform automated operations.

The remote controller's Multi-Aircraft Control mode can be used to coordinate the operation of up to five aircraft at the same time, enabling pilots to work very efficiently.

Image data from the Phantom 4 RTK can be used to generate maps for field planning when operating a DJI AGRAS™ aircraft. Users can also import photos to the DJI PC GS Pro application or third-party mapping software to composite highly accurate maps for different applications.

Installation

Preparing the Aircraft

1. Remove the gimbal clamp from the camera as shown below:

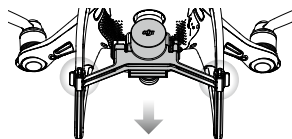

* This should be used with Network RTK service, a DJI D-RTK 2 High-Precision GNSS Mobile Station (purchased additionally) or post-processed kinematic (PPK) data (recommended when RTK signal is weak during operation).

2. Attaching the Propellers

Mount the propellers with black propeller rings to the motors with black dots. Mount the propellers with silver propeller rings to the motors without black dots. Press the propeller down onto the mounting plate and rotate in the lock direction until it is secured.

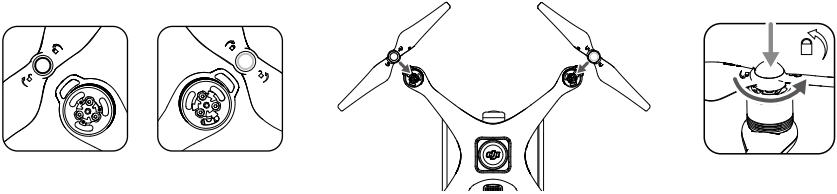

3. Battery Installation

Slide battery into the battery compartment according to the arrow's direction as shown below.

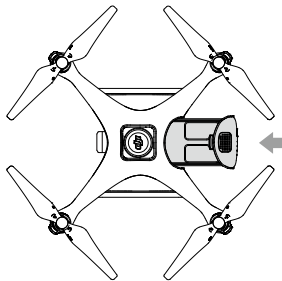

When the upper and lower buckles on the battery are in place, a click sound indicates the battery is securely installed. Failure to do so may affect the flight safety of your aircraft.

Preparing the Remote Controller

1. Mounting the Remote Controller Battery

The remote controller uses an easily removable interchangeable Intelligent Battery for long-term operation.

- ① Slide the battery compartment cover lock on the back of the remote controller down to open the cover.
- ② Insert the Intelligent Battery into the compartment and push it to the top.
- ③ Close the cover.

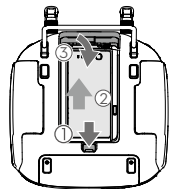

To remove the Intelligent Battery, open the cover, press and hold the battery release button, then push the battery downward.

2. Mounting the Dongle and SIM Card

- ① Lift the dongle compartment cover at the gap at its lower right corner, then remove it.
- ② Insert the dongle into the USB port with the SIM card inserted into the dongle and test. *
- ③ Re-mount the cover. To secure the cover, open the silicone protectors on it, insert and tighten two Phillips screws, then close the protectors.

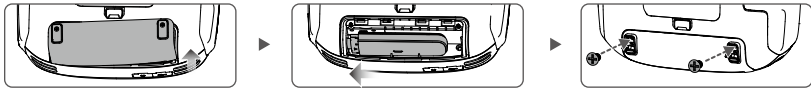

* Test procedure: Press the remote controller power button once, then press again and hold to turn the remote controller on. In the DJI GS RTK app tap > and select Network Diagnostics. If the statuses of all the devices in the network chain are shown in green the dongle and SIM card are functioning properly.



- The Phantom 4 RTK remote controller can access the Internet using a 4G dongle with SIM card or Wi-Fi signal. For UK, EU, ACUK, or ACEU versions, a Network RTK server can only be accessed using a 4G dongle with SIM card. For NA, AU or AFUS versions, using a 4G dongle with SIM card is recommended, but a Wi-Fi signal can also be used. To confirm the version of your unit, please view the version code after the product name on the label on the product packaging. When uploading or downloading system logs or operation data, using a Wi-Fi signal for Internet access is recommended.
- Only use a DJI approved dongle.
- The dongle supports various network standards. Use a SIM card that is compatible with the chosen mobile network provider and select a mobile data plan according to the planned level of usage.
- The dongle and SIM card are used to enable the remote controller to access to specific networks and platforms, such as the DJI AG platform. Be sure to mount them correctly, or else network access will not be available.

3. Unfolding the Remote Controller

Tilt the display device on the remote controller to the desired position, then adjust the antennas so they are facing outward.

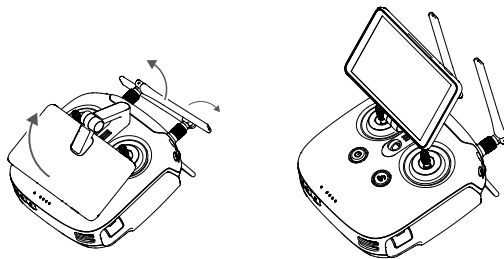

Aircraft Overview

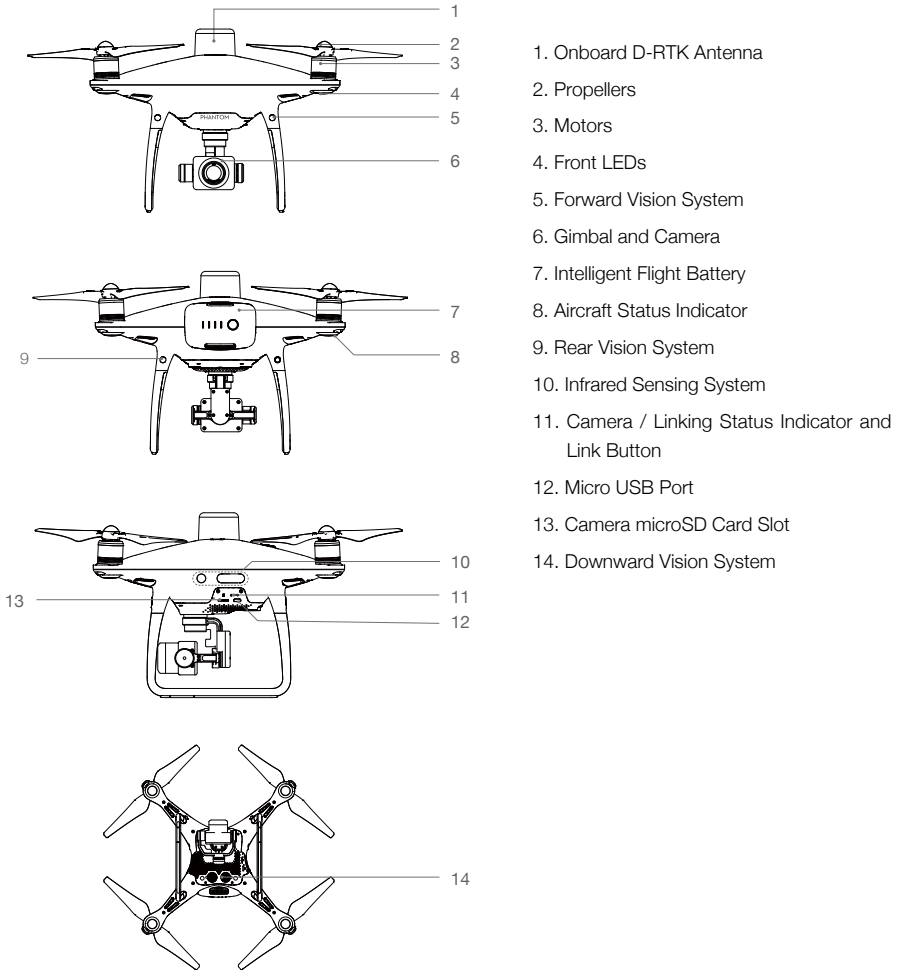

Remote Controller Overview

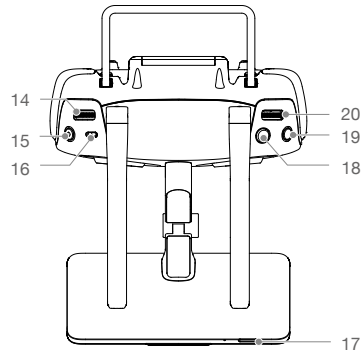
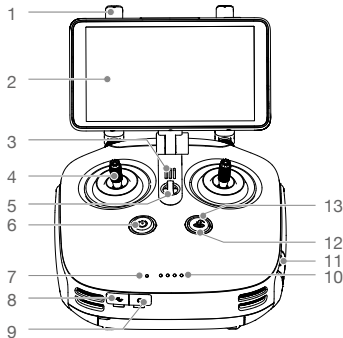

1. Antennas
Relays aircraft control signals.
2. Display Device
Android-based to run the DJI MG app.
3. Speaker
Audio output.
4. Control Sticks
Controls aircraft movement. Can be set to Mode 1, Mode 2, or a custom mode.
5. Lanyard Attachment
Used to attach the remote controller lanyard.
6. Power Button
Used to turn the remote controller on and off.
7. Status LED
Indicates whether the remote controller is linked to the aircraft.
8. USB-C Port
Connects to a computer via a USB-C cable for configuration. Connects to the aircraft via a USB-C OTG cable and a Micro USB cable for aircraft firmware update.
9. 3.5 mm Audio Jack
Used to connect audio input/output devices.
10. Battery Level LEDs
Displays current battery level.
11. MicroSD Card Slot
Provides display device with up to 128 GB of extra storage.
12. RTH Status LED
Circular LED around the RTH button. Displays RTH status.
13. RTH Button
Press and hold this button to initiate Return to Home (RTH).
14. Gimbal Dial
Use this dial to control the tilt of the gimbal.
15. Video Recording Button
Press to start recording video. Press again to stop recording.
16. Pause Switch
During a Photogrammetry or Waypoint operation, toggle to pause the operation.
During RTH, toggle to pause RTH.
17. Sleep/Wake Button
Press to sleep/wake the screen; press and hold to restart.
18. Shutter Button
Press to take a photo.
19. Reserved Button
20. Aircraft Control Switch Dial
Turn and press the dial to switch among the aircraft when using Multi-Aircraft Control function.

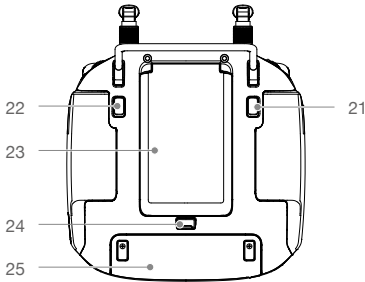

21. Button C1

Press Button C1 to switch between Map View and Camera View.

22. Button C2

When you are planning a Waypoint Flight operation, it adds a waypoint. The button is disabled in any other operations.

23. Battery Compartment Cover

Open the cover to mount or remove the Intelligent Battery from the remote controller.

24. Battery Compartment Cover Lock

Slide the lock down to open the cover.

25. Dongle Compartment Cover

Open the cover to mount or remove the dongle.

Aircraft

This section introduces the aircraft components, features and functions.



Aircraft

Profile

The Phantom 4 RTK aircraft includes a flight controller, a communication system, a positioning system, a propulsion system and an Intelligent Flight Battery. This section describes the functions of these components.

Flight Modes

The Phantom 4 RTK uses a DJI dedicated flight controller, which provides the flight modes below:

P-mode (Positioning): P-mode works best when the GNSS signal is strong. The aircraft utilizes the GNSS / RTK module and Vision System to automatically stabilize itself, navigate between obstacles, and perform a Photogrammetry or Waypoint Flight operation.

When the GNSS signal is strong, the aircraft uses GNSS for positioning. When RTK module is enabled and the differential data transmission is good, it provides centimeter-level positioning. When the GNSS signal is weak and the lighting conditions are sufficient, the aircraft uses Vision System for positioning.

When the forward obstacle sensing is enabled and lighting conditions are sufficient, the maximum flight attitude angle is 25° with a maximum flight speed of 31 mph (50 kph). When forward obstacle sensing is disabled, the maximum flight attitude angle is 35° and the maximum flight speed is 36 mph (58 kph).

A-mode (Attitude): GNSS and Vision System are NOT used for positioning and aircraft can only maintain altitude using the barometer. It enters A-mode only when there is weak GNSS signal or when the compass experiences interference where the Vision System is unavailable.

Attitude Mode Warning

The aircraft will fly in P-mode by default. It enters A-mode only when there is weak GNSS signal or when the compass experiences interference where the Vision System is unavailable.

In A-mode, the Vision System and some advanced features are disabled. Therefore, the aircraft cannot position or auto-brake in this mode and is easily affected by its surroundings, which may result in horizontal shifting. Use the remote controller to position the aircraft.

Maneuvering the aircraft in A-mode can be difficult. Avoid flying in areas where GNSS signal is weak, or in confined spaces. The aircraft will otherwise be forced to enter A-mode, leading to potential flight risks, please land it in a safe place as soon as possible.

Aircraft Status Indicators

The Phantom 4 RTK has Front LEDs and Aircraft Status Indicators. The positions of these LEDs are shown in the figure below:

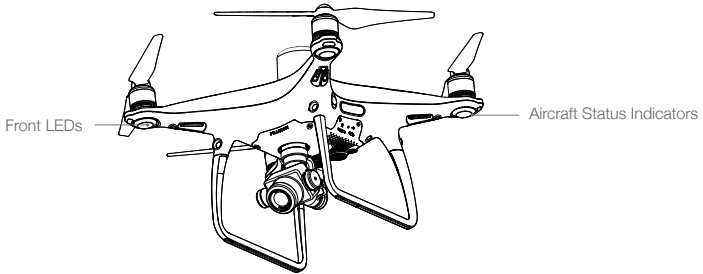

The Front LEDs show the orientation of the aircraft. The Front LEDs glow solid red when the aircraft is turned on to indicate the front (or nose) of the aircraft. The Aircraft Status Indicators communicate the system status of the flight controller. Refer to the table below for more information about the Aircraft Status Indicators.

Aircraft Status Indicator Description

Normal



..... Alternate red, green and yellow flashing	Turning On and Self Diagnostic Testing
..... Alternate green and yellow flashing	Warming Up
..... Slow green flashing	P-mode with GNSS or RTK
..... Two green flashes	P-mode with Vision System
..... Slow yellow flashing	A-mode but No GNSS or Vision System
..... Fast green flashing	Braking

Warning

..... Fast yellow flashing	Remote Controller Signal Lost
..... Slow red flashing	Low Battery Warning
..... Fast red flashing	Critical Battery Warning
..... Red flashing	Uneven Placement or Large Sensors Bias
— Solid red	Critical Error
..... Alternate red and yellow flashing	Compass Calibration Required

Return to Home (RTH)

Return to Home (RTH) function brings the aircraft back to the last recorded Home Point. There are three types of RTH: Smart RTH, Low Battery RTH, and Failsafe RTH. This section describes these three scenarios in detail.

	GNSS	Description
Home Point		If a strong GNSS signal was acquired before takeoff, the Home Point is the location from which the aircraft launched. The GNSS signal strength is indicated by the GNSS icon (). Less than 4 bars is considered a weak GNSS signal). The aircraft status indicators will blink rapidly when the home point is recorded.



- The aircraft can sense and avoid obstacles when the Forward Vision System is enabled and lighting conditions are sufficient. The aircraft will automatically climb up to avoid obstacles and descend slowly as it returns to the Home Point. To ensure the aircraft returns home forwards, it cannot rotate or fly left and right during RTH while the Forward Vision System is enabled.

Updating the Home Point







You can update the Home Point in the DJI GS RTK app during flight. There are two options for setting the Home Point:

1. Set the aircraft's current coordinates as the Home Point.
2. Set the remote controller's current coordinates as the Home Point.



- Ensure the space above the remote controller's GNSS module (located beneath the DJI logo) is not obstructed and that there are no tall buildings around when updating the Home Point.

Follow the instructions below to update the Home Point:

1. Go to DJI GS RTK > Fly.
2. Tap  >  , select  in Home Point settings to set the aircraft's current coordinates as the Home Point.
3. Tap  >  , select  in Home Point settings to set the remote controller's current coordinates as the Home Point.
4. The Aircraft Status Indicator will blink green to indicate that the new Home Point has successfully been set.

Failsafe RTH

The Forward Vision System allows the aircraft to create a real-time map of its flight route as it flies. If the Home Point was successfully recorded and the compass is functioning normally, Failsafe RTH will be automatically activated if the remote controller signal is lost for more than three seconds. The aircraft will plan its return route and retrace its original flight route home. During RTH, if the remote controller signal is recovered, users can control the aircraft altitude and speed. Press the RTH button once to cancel RTH.

Failsafe Illustration

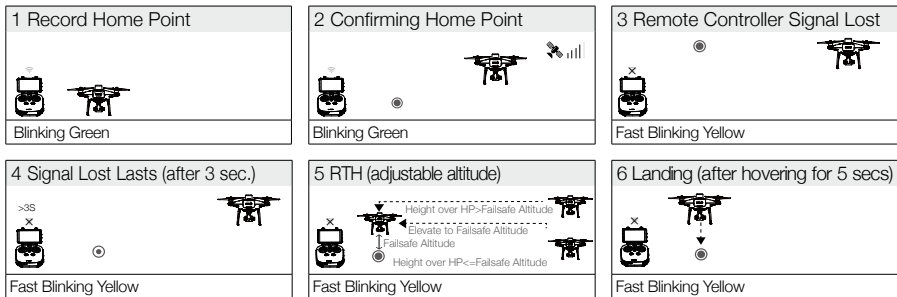

Smart RTH

Use the RTH button on the remote controller when GNSS is available to initiate Smart RTH. The aircraft will then automatically return to the last recorded Home Point. Use the remote controller to control the aircraft's speed or altitude to avoid a collision during the Smart RTH process. As the aircraft returns, it will use the primary camera to identify obstacles as far as 300m in front, allowing it to plan a safe route home. Press and hold the Smart RTH button once to start the process, and press the Smart RTH button again to terminate the procedure and regain full control of the aircraft.

Low Battery RTH

The low battery level failsafe is triggered when the DJI Intelligent Flight Battery is depleted to a point that may affect the safe return of the aircraft. The user can cancel the RTH procedure by pressing the RTH button on the remote controller. The thresholds for these warnings are automatically determined based on the aircraft's current altitude and distance from the Home Point. The Low Battery RTH will only be triggered once during the same flight.

The aircraft will land automatically if the current battery level can only support the aircraft long enough to descend from its current altitude. The user cannot cancel the auto landing but can use the remote controller to alter the aircraft's orientation during the landing process.

The Battery Level Indicator is displayed in the DJI GS RTK app, and is described below:

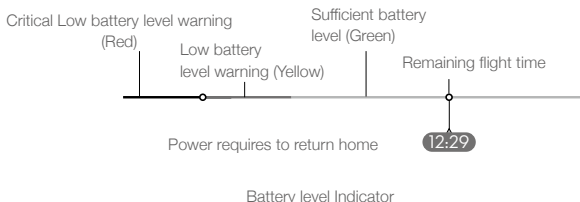

Battery Level Warning	Remark	Aircraft Status Indicator	DJI GS RTK App	Flight Instructions
Low battery level warning	Battery power is low. Fly the aircraft back.	Aircraft status indicator blinks RED slowly.	N/A	The aircraft will return to the Home Point automatically and hover at 2 meters above the Home Point. Users can also cancel the RTH process and land manually. Note: The Low Battery Level Warning will not prompt after users cancel RTH and regain control.
Critical Low battery level warning	The aircraft must land immediately.	Aircraft status indicator blinks RED quickly.	The DJI GS RTK app display will flash red and the aircraft will start to descend. The remote controller will sound an alarm.	Allow the aircraft to descend and land automatically.
Estimated remaining flight time	Estimated remaining flight based on current battery level.	N/A	N/A	N/A



- When the Critical low battery level warning is triggered and the aircraft begins to land automatically, push the left stick upward to make the aircraft hover at its current altitude, giving you an opportunity to navigate to a more appropriate landing location.
- The colored zones and markers on the battery level indicator bar reflect the estimated remaining flight time. They are automatically adjusted according to the aircraft's current location and status.
- The Low Battery Warning threshold set in the Aircraft Battery settings page in the app is only for an alert and will not trigger RTH.

Precision Landing

The aircraft automatically scans and attempts to match the terrain features underneath during Return to Home. When current terrain matches home point terrain, the aircraft will start landing immediately to achieve precision landing.



- Landing Protection is active during precision landing.
- Precision Landing performance is subject to the following conditions:
 - a) Home point is recorded upon take off, and cannot not be refreshed during flight.
 - b) Aircraft must take off vertically. Take off altitude must be greater than 7 meters.
 - c) Home point terrain features remain largely unchanged.
 - d) Home point terrain with no distinctive features will affect the performance.
 - e) Lighting conditions cannot be too light nor too dark.
- The following actions are available during landing:
 - a) Pull throttle down to accelerate landing.
 - b) Moving the control sticks in any other direction will stop Precision Landing. The aircraft will descend vertically and Landing Protection will remain active.

RTH Safety Notices



The aircraft cannot avoid obstruction during RTH when the Forward Vision System is disabled. Users can use the remote controller to control aircraft altitude and speed. It is important to set a suitable Failsafe altitude before each flight. Launch the DJI GS RTK app, tap ●●● and tap  to set the Failsafe Altitude.







If the aircraft is flying under 65 feet (20 meters) and RTH (including Smart RTH, Low Battery RTH and Failsafe RTH) is triggered, the aircraft will first automatically ascend to 65 feet (20 meters) from the current altitude. You can only cancel the ascending by exiting the RTH.



The aircraft will automatically descend and land if RTH is triggered when the aircraft flies within a 16-feet (5 meters) radius of the Home Point and when the aircraft altitude is under 98 feet (30 meters), or if the obstacle sensing function is disabled. The aircraft will not ascend, and will land immediately at the current location.



Aircraft cannot return to the Home Point when GNSS signal is weak (    ) displays grey) or the module is unavailable.



If you move the throttle stick after the aircraft rises above 65 feet (20 meters) but below the pre-set Failsafe RTH altitude, the aircraft will stop ascending and immediately return to the Home Point.

Obstacle Avoidance During RTH

Aircraft can now sense and actively attempt to avoid obstacles during RTH, provided that the lighting conditions are adequate for the Forward Vision System. Upon detecting an obstacle, the aircraft will act as follows:

1. The aircraft will use the primary camera to identify obstacles as far as 984 feet (300 meters) in front, allowing it to plan a safe route home.
2. The aircraft decelerates when an obstacle is sensed at 49 feet (15 meters) ahead.
3. The aircraft stops and hovers then starts ascending vertically to avoid the obstacle. Eventually, the aircraft will stop climbing when it is at least 16 feet (5 meters) above the detected obstacle.
4. Failsafe RTH procedure resumes, the aircraft will continue flying to the Home Point at the current altitude.

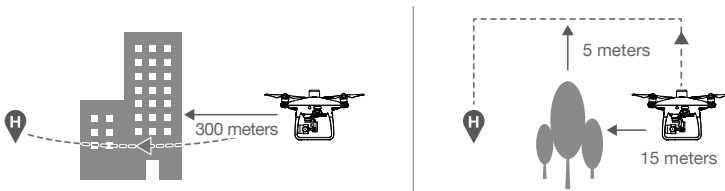

- The Obstacle Sensing function is disabled during RTH descent. Operate with care.
- To ensure the aircraft returns home forwards, it cannot rotate during RTH while the Forward Vision System is enabled.
- The aircraft cannot avoid obstacles above, beside, or behind the aircraft.

Landing Protection Function

Landing Protection will activate during auto landing.

1. Landing Protection determines whether the ground is suitable for landing. If so, the aircraft will land gently.
2. If Landing Protection determines that the ground is not suitable for landing, the aircraft will hover and wait for pilot confirmation. The aircraft will hover if it detects the ground is not appropriate for landing even with a critically low battery warning. Only when the battery level decreases to 0% will the aircraft land. Users retain control of aircraft flight orientation.
3. If Landing Protection is inactive, the DJI GS RTK app will display a landing prompt when the aircraft descends below 0.3 meters. Tap to confirm or pull down the control stick for 2 seconds to land when the environment is appropriate for landing.



- Landing Protection will not be active in the following circumstances:
 - a) When the user is controlling the pitch/roll/throttle sticks (Landing ground detection will re-activate when control sticks are not in use)
 - b) When the positioning system is not fully functional (e.g. drift position error)
 - c) When the Downward Vision System needs re-calibration
 - d) When light conditions are not sufficient for the Downward Vision System
- If an obstacle is within 1-meter of the aircraft, the aircraft will descend to 0.3m above the ground and hover. The aircraft will land upon with user confirmation.

Industrial Applications

The Phantom 4 RTK can be used for industrial applications including but not limited to, photogrammetry and power line inspections. Select Photogrammetry, Waypoint Flight, Linear Flight, Terrain Awareness, or Block Segmentation, plan flight paths, set parameters, and then the aircraft will perform automated operations. Operation resumption and obstacle avoidance are available. Users can import images to the DJI PC GS Pro application or a third-party mapping software to composite highly accurate maps for different applications. KML/KMZ files can be imported into the DJI GS RTK app to help plan operations.



KML/KMZ File Import

To plan operations, insert the microSD card with the KML/KMZ files into the microSD card slot on the remote controller to import the files into DJI GS RTK. For files including polygons, users can view the data on the map and use it to plan flight areas. For files including line strings, users can only view the data on the map, but cannot use it for planning.



Preparing Files

1. Create a folder named "DJI" in the root directory of the microSD card. Then create a folder named "KML" under this folder. (The letters are not case sensitive.)
2. Store the KML/KMZ files into the "KML" folder created above.

Importing Files

1. Insert the microSD card into the microSD card slot on the remote controller. There will be a pop-up window on the main screen in the DJI GS RTK app then. If not, tap , then tap .
2. Tap the file in the window to select it. To delete the file, swipe to the left and tap . Select files and then tap to import the files. Wait until the app indicates successful import.

Viewing Files

1. Go DJI GS RTK main screen >  > , select KML Files in the drop-down menu on the top to view the files. They are sort by time. KML file names displayed in the app are the original names of the files. KMZ files will be named in sequence: doc, doc(1), doc(2), etc.
2. Tap the icon on the right of each file to enter Map View and view the data on the map.



Users can also tap  on the left in Camera View or Map View, and then select KML File in the drop-down menu to enter the file list page.

3. Tap Edit to edit the waypoints for photogrammetry operation planning if the waypoint number is fewer than 125. Refer to the Photogrammetry section below for details on operation planning. If the waypoint number is more than 125, users have to reimport KML/KMZ files that meet the requirements.

Photogrammetry

After the operation area has been set, and settings have been configured, the DJI GS RTK app produces a flight route based on the user's input. After planning, the aircraft can carry out automated operations following the flight route. There are three types of Photogrammetry operations: 2D, 3D (Double Grid) and 3D (Multi-oriented). The 2D flight route is s-shaped and can be used for digital orthophoto map (DOM). The 3D (Double Grid) flight route consists of s-shaped routes that are crisscrossed to create 3D models. The default values of the gimbal pitch angle for the two types are different. The 3D (Multi-oriented) flight routes consist of

a single nadir view flight path and four oblique flight paths to create more accurate 3D models.

Planning a Flight Route

1. Add edge points of the operation area through the two methods below:
 - View the imported KML/KMZ file, and then tap Edit. The vertices of the polygon in the file will be converted to the edge points of the operation area.
 - Go to the main screen in the DJI GS RTK app, tap Plan, and select Photogrammetry to enter Planning View. Then tap on the map to add edge points.
2. Edit edge points

Move: Drag the point to move.

Fine Tuning: Tap the point to show Fine Tuning buttons. Tap to adjust.

Delete: Tap twice to delete a point.
3. Settings: After points are added, there will be a settings list on the right screen. Configure the settings and the app will produce a corresponding flight route.
4. Adjust the route direction: Tap and drag the  icon near the route to adjust the flight direction of the produced route.
5. Tap Save, name the operation, and then tap OK.

Waypoint Flight

Fly the aircraft to desired positions, add waypoints and configure settings and actions for each waypoint. The waypoints will produce a flight route in sequence. After the operation is started, the aircraft will fly alongside the route and perform pre-set actions at each waypoint.

Planning Route

1. Go to the main screen in the DJI GS RTK app, tap Plan, and select Waypoint Flight to enter Planning View.
2. Fly the aircraft to the desired position, and short press the C2 Button on the remote controller once to add a waypoint.



The position of the added waypoints cannot be adjusted. Users can edit the waypoint for other configurations. See details below.

3. Edit waypoints

Tap the added waypoint on the map and there will be a settings list on the screen. Tap < / > to switch among the waypoints to edit each waypoint.

Altitude: The relative altitude between the aircraft and the Home Point at the selected waypoint. The aircraft will ascend or descend gradually to the altitude pre-set at the next waypoint if the values at the two consecutive waypoints are different. Tap the button, and then slide up or down anywhere on the screen to adjust the value.

Heading: The aircraft heading at the selected waypoint. North is 0°, with a positive value indicating clockwise and a negative value indicating counter clockwise. The aircraft will rotate gradually to the heading pre-set at the next waypoint if the values at the two consecutive waypoints are different. Tap the button, and then slide up or down anywhere on the screen to adjust the value.

Pitch: The gimbal pitch angle at the selected waypoint. Pitch angle can range from -90° to 0°, with downward represented by -90° and forward represented by 0°. The gimbal will tilt to the angle pre-set

after reaching the selected waypoint. Tap the button, and then slide up or down anywhere on the screen to adjust the value.

Action: Waypoint actions include: single shot, 3 continuous shots and none.

 : Tap to delete the selected waypoint.



Users cannot add waypoints during Edit Mode. Waypoints can be added after tapping Save or Cancel in the settings list.

4. Route settings: After waypoints are added, tap the route settings button on the lower right corner to set an ending action for a task, action for when RC signal is lost, aircraft heading, cruising speed, and route recording. (Note that if route recording is enabled, shooting actions set for all the waypoints will be disabled, and the raw satellite observations will not be recorded.) Close the menu after configuration.
5. Tap Save, name the operation, and then tap OK.

Linear Flight Mission

The DJI GS RTK app automatically generates linear flight area and several independent flight paths after the user has set the linear flight points, expansion distance, and linear flight cutting distance. Users perform the operation, and the aircraft will automatically fly alongside the selected flight paths in the linear flight area.

Planning a Flight Route

1. Add linear flight points by:
 - Viewing the imported KML/KMZ file, and then tapping Edit to convert points in the file to points in a linear flight mission.
 - Going to the main screen in the DJI GS RTK app, tapping Plan, and selecting Linear Flight to enter Planning View. Then tap on the map to add linear flight points.
2. Edit linear flight points
 - Move: Drag the point to move.
 - Delete: Tap twice to delete a point.
3. After points are added, there will be a settings list on the right side of the screen. Configure the settings accordingly.
 - Expansion Distance to Left or Right: Adjusts the expansion distance to the left or right of the linear flight area, where the front is defined by the line that any point on the linear flight path makes with the previous point.
 - Linear Flight Cutting Distance: Divides linear flight areas with a long center line into multiple segments according to this setting.
4. Tap Generate Flight Route. The app will generate the corresponding flight route. Each segment will have a sub-mission with an independent flight route if the linear flight area is divided. Users can select the desired flight route before performing the operation. Tap Back to edit the linear flight points and settings mentioned above if needed.
5. After the flight route is generated, there will be a settings list on the right side of the screen. Configure the settings accordingly. If sub-missions are created, the settings will apply to all of them.
 - Height: The altitude of the aircraft during the operation.
 - Speed: The flight speed during the operation.
 - Working Mode: The area where images are collected and the flight route generated will vary in different working modes. If Full Coverage is selected, the flight route will include an extra path on both sides of the linear flight area. If Efficiency is selected, the flight route will just cover the linear flight area.

Shooting Mode: Select between Timed Shooting and Distance Shooting.

Finish: Aircraft action after the operation is completed. Users can choose from RTH, hovering, landing, and returning to the first flight point.

Flight route generated along center line: Select whether the flight route generated will include the center line. The center line refers to the line made by connecting the linear flight points added when planning the flight route.

Camera Settings: Includes photo ratio, white balance, gimbal angle, shutter priority and distortion correction.



If distortion correction is enabled, the image quality may be lower due to processing. It is recommended to disable this option when original images are need for post processing.

Advanced Settings: Includes horizontal overlapping rate and vertical overlapping rate. The vertical overlapping rate is the overlapping rate of two pictures captured consecutively in the same heading along the flight path. The horizontal overlapping rate is the overlapping rate of two pictures taken on two parallel paths.

6. Tap Save, name the operation, and then tap OK.

Terrain Awareness Mode

Import DSM files including altitude information to plan a Terrain Awareness Mode operation and perform precise terrain follow flight.



Preparing Files

1. Create a folder named "DJI" in the root directory of the microSD card. Then create a folder named "DSM" under this folder. (The letters are not case sensitive.)
2. In the DSM folder created in the previous step, create a folder for each DSM data set, and then put the TIF and TFW files or a TIF file including TFW strings in the folder.



Make sure that there is only one TIF file and one TFW file in each folder. Otherwise, the files may not be identified when importing.

Importing Files

1. Insert the microSD card into the microSD card slot on the remote controller. A window will pop up on the main screen in the DJI GS RTK app. If not, tap , then tap .
2. Tap the file in the window to select it. Once selected, swipe to the left and tap  to delete the file, or tap Import to import the files. Wait until the app indicates a successful import.

Planning a Flight Route

1. Go to the main screen in the DJI GS RTK app, tap Plan, and select Terrain Awareness Mode to enter Planning View. There will be a list of imported DSM files on the right side of the screen.
2. Tap the desired DSM file, and then tap Plan Task.
3. A white dotted box on the center of the map will indicate the area covered by the DSM file. Add and edit edge points of the operation area in the white dotted box by:
 - Tapping the KML icon on the top of the screen, select the KML/KMZ file, and then tap Import. The points in the file will be converted to the edge points for the operation area.
 - Tapping on the map to add edge points.

Edit the edge points to adjust the location and shape of the operation area. The instructions are similar to those for Photogrammetry operations.

 If the points imported through the KML/KMZ file are outside of the dotted box, edit them to make sure they are in the white dotted box so the operation can be performed.

4. After the edge points are added, the app will produce the flight route automatically. The curve of the altitude of the whole flight route will be displayed at the bottom of the screen. Tap the point on the curve to show the altitude of this point and the corresponding waypoint on the flight route will turn blue.
5. Configure other settings accordingly.
6. Tap Save, name the operation, and then tap OK.

Linear Flight (Adjustable Height)

Fly the aircraft to the target object and set the position and altitude of the aircraft as a point in the flight area or import a KML file to add points, and then configure the extension length and other settings. The app will automatically generate the corresponding linear flight area and flight routes. Once chosen, the mission will be carried out automatically, following the flight route in the linear flight area. This feature best captures corridor areas with large changes in elevation, for example, power line corridors, highways, or rivers.

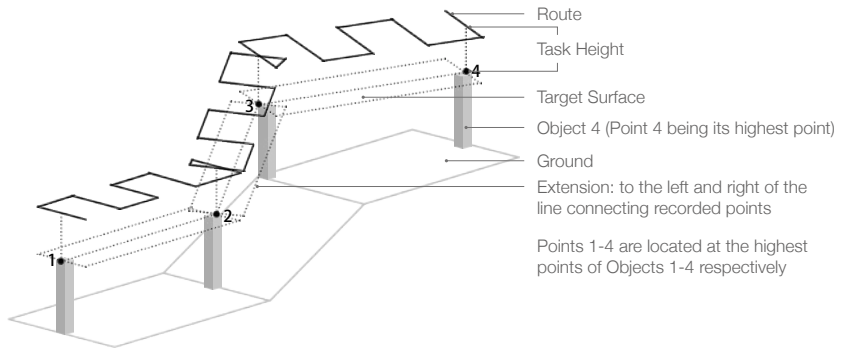

Planning a Flight Route

Go to the main screen in the DJI GS RTK app, tap Plan, and select Linear Flight (Adjustable Height) to enter Planning View. Read the instructions in the app carefully before planning.

1. Select the height mode for the added points: Relative Height refers to the relative height above the takeoff point. Absolute Height refers to the actual elevation. The datum of this elevation should be consistent with the elevation datum used for aircraft positioning, such as the ellipsoidal height in the CGCS2000 or WGS84 system.
2. Add points in the linear flight area using one of the two methods below:
 - Make sure to import the KML/KMZ files according to the instructions mentioned above. Tap the KML button to the right of Planning View and select the desired file to convert the points in the file into points in a Linear Flight (Adjustable Height) operation.
 - Fly the aircraft to the top of the target object, and then press the C2 button on the remote controller once.
3. Edit the points: Tap the point to select it and adjust its height. Tap twice to delete a point.



- In Absolute Height mode, make sure to use RTK positioning. In Relative Height mode, the takeoff points for planning tasks and for executing tasks must be at the same height.
- When importing KML/KMZ files, make sure that the type of coordinates in the file is “LineString” and that the altitude mode is “absolute”. If the altitude mode is not “absolute” or there is no information for altitude mode, only latitude and longitude data will be imported. Users can set height for each point according to the height mode preset in the DJI GS RTK app.
- In Absolute Height mode, follow the instructions below to obtain a more precise absolute height for the point in the flight area. Firstly, fly the aircraft to the point and add the point using the latitude and longitude of the aircraft. Then fly to one side of the target object, set the gimbal angle to 0, which means that the gimbal is facing the front of the aircraft, and move the aircraft to align the center of the Camera View to the top of the object. Mark down the rtkH value on the left lower corner of the screen and set the height of the corresponding point to this rtkH value.

4. Set the extension length: Tap Extension and set the extension length to the left and right when generating the linear flight area. Left or right refers to either side of the line connecting recorded points. The dotted box displayed on the screen after configuration is a preview of the width of the linear flight area.
5. Tap Next, and the app will automatically generate a corresponding flight route, which is a single route covering the whole linear flight area.
6. After the flight route is generated, there will be a settings list on the right side of the screen. Configure the settings accordingly.
The height in the settings list refers to the aircraft's vertical height relative to the plane where the added point in the linear flight area is when performing the operation. Other settings are similar to the ones for other operation types.
7. Tap Save, name the operation, and then tap OK.

Angled Flight Route

In Angled Flight Route operations, points A, B, and C can define the inclined or vertical target plane so that users can plan and execute missions. Fly the aircraft to the desired positions and set the position and altitude of the aircraft as points A, B and C to define the angled plane, or import a KML file to add points, and then configure the extension length and other settings. The app will automatically generate the corresponding flight area and flight routes. Once chosen and configured, mission will be carried out automatically, following the flight route in the flight area. This is suitable for photogrammetry data acquisition for reconstructions of slopes and buildings.

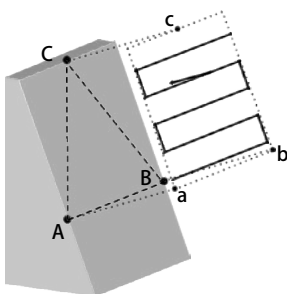

Perpendicular to Target Surface

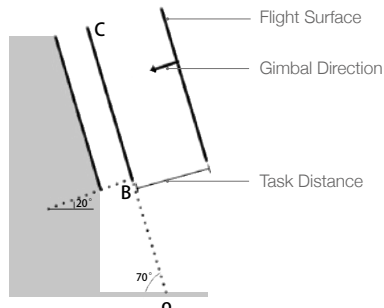

Perpendicular to Target Surface (Side View)

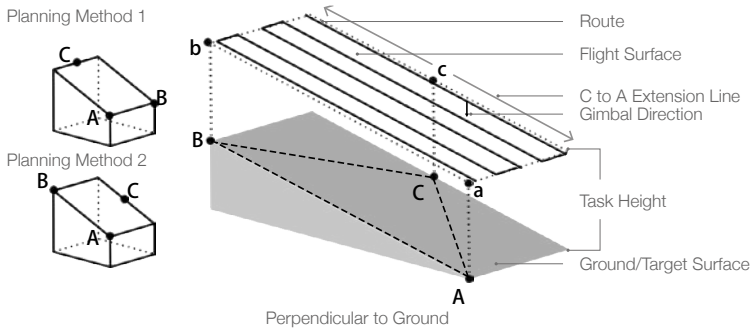

Planning a Flight Route

Go to the main screen in the DJI GS RTK app, tap Plan, and select Angled Flight Route to enter Planning View. Read the instructions in the app carefully before planning.

1. Select the height mode for points A, B, and C: Relative Height refers to the relative height above the takeoff point. Absolute Height refers to the actual elevation. The datum of this elevation should be consistent with the elevation datum used for aircraft positioning, such as the ellipsoidal height in the CGCS2000 or WGS84 system.
2. Add points using one of the two methods below:
 - Make sure to import the KML/KMZ files according to the instructions mentioned above. Tap the KML button to the right of Planning View and select the desired file to convert points in the file into points A, B, and C.
 - Fly the aircraft to the desired position, and then press the C2 button on the remote controller once.
3. Edit the points: Tap the point to select it and adjust its height. Tap twice to delete a point.



- In Absolute Height mode, make sure to use RTK positioning. In Relative Height mode, the takeoff points for planning tasks and for executing tasks must be at the same height.
- When importing KML/KMZ files, make sure that the type of coordinates in the file is “LinearRing” and that the altitude mode is “absolute”. If the altitude mode is not “absolute” or there is no information for altitude mode, only latitude and longitude data will be imported. Users can set height for points A, B, and C according to the height mode preset in the DJI GS RTK app.

4. Set the extension length: Tap Extension and set the extension length from point C to its left and right when generating the flight area. C to A Extension Length refers to the length from point C to A on the direction parallel to line AB while C to B Extension Length refers to the length from point C to B. The dotted box displayed on the screen after configuration is the preview for the flight area.
5. Tap Next, and the app will automatically generate a corresponding flight route.
6. After the flight route is generated, there will be a settings list on the right side of the screen. Configure the settings accordingly. Users can preview the actual shape of the flight route in the separate window at the bottom of the screen. Tap the  icon on the lower right corner of the separate window to collapse or expand the preview.

Distance: When gimbal mode is set to Perpendicular to Target Surface, this value refers to the distance between the aircraft and ABC surface on the direction perpendicular to the ABC surface when performing the operation. When gimbal mode is set to Perpendicular to Ground, this value refers to the vertical distance between the aircraft and the ABC surface when performing the operation.

Gimbal Mode: Perpendicular to Target Surface means that the gimbal faces to the ABC surface. Perpendicular to Ground means that the gimbal faces to the ground. Other settings are similar to the ones for other operation types.





When using the aircraft to set points A, B, and C, it may be hard to fly the aircraft to an exact position in relation to the target surface, which means that the aircraft may be at a height difference from the target surface. In this case, the actual overlap rate may be lower than the setting. Users can increase the overlap rate accordingly.

7. Tap Save, name the operation, and then tap OK.

Performing Operations

An operation can be performed directly after planning. Follow the instructions below if the operation was not used immediately.

1. Power on the remote controller, and then power on the aircraft.
2. Go to the main screen in the DJI GS RTK app, and then tap Fly.
3. Tap  in the Camera View for camera settings. Tap  on the left, select Plan in the drop-down menu, and then select an operation route. Tap the map to enter Edit Status to edit the waypoints and adjust operation settings, and then save.
4. Tap Invoke, and then tap Start. Wait for the flight route uploaded to the aircraft.
5. Takeoff and perform the operation.
 - ① If you fly the aircraft manually, slide to start the operation.
 - ② If the aircraft is on the ground, slide to takeoff and start the operation.

Block Segmentation

Block Segmentation operations can be used to divide the operation area into several small blocks when the operation area is large. Users can then fly one aircraft to cover each block or fly several aircraft using the Multi-Aircraft Control function to cover different blocks.

Planning a Flight Route

1. Add edge points of the operation area by:
 - Viewing the imported KML/KMZ file, and then tapping Edit. The points in the file will be converted to the edge points of the operation area.
 - Going to the main screen in the DJI GS RTK app, tapping Plan, and selecting Block Segmentation to enter Planning View. Then tap on the map to add edge points.
2. Edit edge points

Move: Drag the point to move.

Fine Tuning: Tap the point to show Fine Tuning buttons. Tap to adjust.

Delete: Tap twice to delete a point.
3. A segmentation grid will be displayed on the map. Configure the grid as follows:

Set the area for segmentation: The size of the grid will change according to the area value for segmentation.

Move the grid: Drag the grid to move.

Adjust the direction of the grid lines: Tap and drag the  icon near the grid to adjust the direction of the grid lines. Tap +/- for fine tuning.

4. Tap Next to divide the operation area into smaller blocks. Each block is a sub-mission. Tap the block to select it and split the block or merge blocks. Tap Back to adjust the grid again if needed.
5. Tap Save, name the operation, and then tap OK.
6. Tap Edit to adjust the grid again. Tap Parameter Configuration to set the height, speed, shooting mode, ending action, camera settings, overlapping rates, and enable altitude optimization. Tap and drag the  icon near the route to adjust the flight direction of the route. These settings will apply to all of the sub-missions.
7. Tap Save, name the operation, and then tap OK.

Mission Assignment

When only one aircraft is used to perform operations, assign the desired blocks to the aircraft after selecting the operation in the operation list.

When multiple aircraft are used to perform operations, link all the aircraft to one remote controller following instructions for the Multi-Aircraft Control function, and then select the operation in the operation list. In this case, bind an aircraft to each block in the aircraft list to assign the corresponding mission.

 Important instructions for performing Block Segmentation operations with multiple aircraft:

- Operate the remote controller at a location central to all the aircraft that will perform the sub-missions to ensure optimal transmission.
 - Switch between aircraft to check all their status to ensure flight safety.
 - Make sure that the distance between each aircraft is more than 5 m. The distance should be further if you want all aircraft to take off at the same time.
-

Performing Operations

1. Tap Start, and then wait for the flight routes to be uploaded to the aircraft.
 2. Slide the slider for each aircraft to perform the mission bound to the aircraft.
 3. Slide the slider at the bottom to take off all of the aircraft and perform all of the missions simultaneously.
-

 You cannot have all aircraft take off at the same time if the number of linked aircraft exceeds the number of blocks.

Elevation Optimization

When planning Photogrammetry (2D), Angled Flight Route (with the gimbal mode of Perpendicular to Ground), or Block Segmentation missions, the elevation optimization option in the parameters list is enabled by default. The aircraft will fly an additional path in the operation area to collect a set of images after the flight to optimize the elevation accuracy.

If elevation optimization is disabled when planning an operation, the configuration works for the current operation only. Elevation optimization will still be enabled when a new operation is created.

Operation Safety Notices



- Only take off in open areas.
 - The operation will be automatically cancelled if the motors are started before beginning the operation. You will need to recall the operation in the operation list.
 - During a Photogrammetry operation, the aircraft heading will follow the flight route. However, users can control the heading (not recommended), and fly forward or backward using the control sticks.
 - During a Waypoint Flight operation, the aircraft heading can be set to follow the flight route or the customized angle pre-set for each waypoint in Route Settings. However, users cannot control the heading with the control stick, but they can control the direction of flight (forward or backward).
 - During the operation, tap Pause on the screen and the aircraft will hover. Users can fly the aircraft forward or backward along the flight route. Tap Resume and the operation will resume from the current position.
 - An operation can be paused by toggling the Pause switch. The aircraft will hover and record the breakpoint, and then the aircraft can be controlled manually. To continue the operation, select it from the list again and then resume. The aircraft will automatically return to the breakpoint and resume the operation.
 - The aircraft will hover at the end point automatically once the operation is complete. Instead of RTH, the aircraft can also be set to perform other flight actions within the app.
-

Operation Resumption

When exiting an operation, the aircraft will record a breakpoint. The Operation Resumption function allows you to pause an operation temporarily (e.g., to change battery, and avoid obstacles manually) and then resume operation at the breakpoint.

Recording a Breakpoint

Exit an operation through one of the following methods and the aircraft will record its location as a breakpoint if GNSS signal is strong:

1. Tap the End button on the lower right corner of the screen.
2. Initialize the RTH procedure.
3. Toggle the Pause switch.
4. If the GNSS signal is weak, the aircraft enters Attitude mode and exits the current operation. The last position where there was a strong GNSS signal is recorded as a breakpoint.



- Ensure that GNSS signal is strong when using the Operation Resumption function. Otherwise, the aircraft cannot record and return to the breakpoint.
 - The breakpoint is updated as long as it meets one of the above conditions.
-

Resuming Operation

1. Exit an operation through one of the above methods. The aircraft will record the current location as the breakpoint.
2. The aircraft will end the current operation and record the operation progress. Users can control the aircraft manually.
3. Select the operation in the Executing tag of the operation list again. The aircraft will automatically return to the breakpoint and resume the operation.

System Data Protection

During an operation, the System Data Protection feature enables the DJI GS RTK app to retain vital system data (e.g. operation progress, breakpoint) after the aircraft is powered off for battery replacement. Follow the instructions in Operation Resumption to resume the operation after restarting the aircraft.

Vision System and Infrared Sensing System

The main components of the Vision System are located on the front, rear and bottom of the aircraft, including [1] [2] [4] three stereo vision sensors and [3] two ultrasonic sensors. The Vision System uses ultrasound and image data to help the aircraft maintain its current position, enabling precision hovering indoors or in environments where a GNSS signal is not available. The Vision System constantly scans for obstacles, allowing the aircraft to avoid them by going over, around, or hovering.

The Infrared Sensing System consists [5] of two 3D infrared modules on both sides of the aircraft. These scan for obstacles on both sides of the aircraft and is active in certain flight modes.

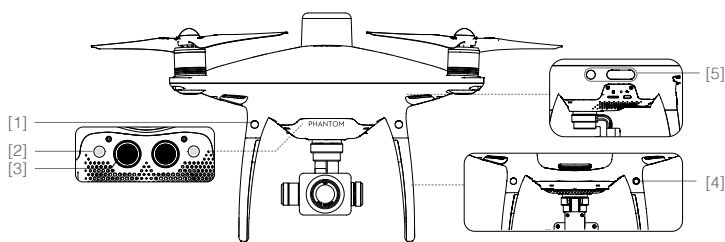

Detection Range

The detection range of the Vision System and Infrared Sensing System are depicted as follow. Note that the aircraft cannot sense and avoid the obstacles that are not within the detection range.

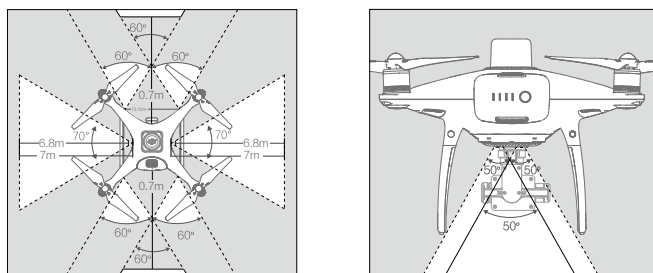

In P-mode, both the forward and the rear Vision Systems work if the speed is within 13mph (22kph). At higher speeds, only the vision system facing the direction of travel is active.

Calibrating Sensors

Vision Systems cameras installed on the aircraft are calibrated on delivery. However these cameras are vulnerable to excessive impact and will require occasional calibration via DJI Assistant 2 for Phantom. Follow the steps below to calibrate the sensors.

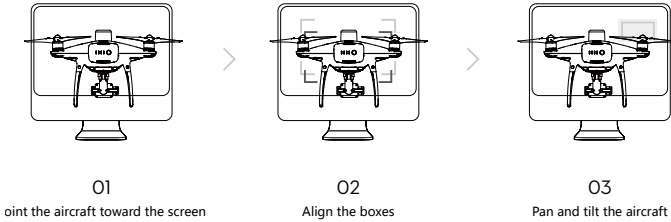

Using Vision Positioning

Vision Positioning is activated automatically when the aircraft is turned on. No further action is required. Vision Positioning is typically used in indoor environments, where GNSS is unavailable. Using the sensors that are built into the Vision System, the aircraft can hover precisely even without GNSS. The Downward Vision System works best when the aircraft is at altitudes of under 33 ft (10 m). Operate the aircraft with great caution when flying at high speeds at low altitudes (under 0.5 m).

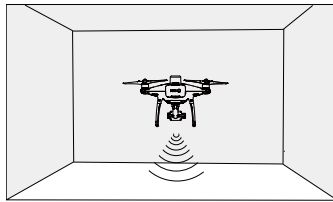

Follow the steps below to use Vision Positioning:

1. Turn on the aircraft. The aircraft status indicator will flash green two times, which indicates the Vision Positioning is ready.
2. Gently push the left stick up to lift off and the aircraft will hover in place.

Assisted Braking from Obstacle Sensing

Powered by the Obstacle Sensing, the aircraft will now be able to actively brake when obstacles are detected around the aircraft. Note that Obstacle Sensing function works best when lighting is adequate and the obstacle is clearly marked or textured. The aircraft must fly at no more than 31mph (50kph) to allow sufficient braking distance.

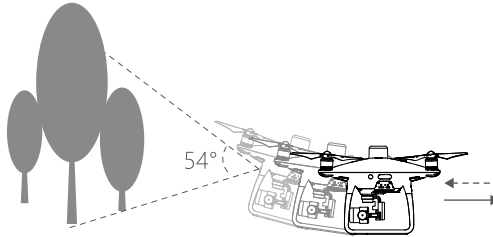

- The 3D Infrared Sensing System is only active in Beginner mode* and Tripod mode*. Fly with caution.
- The performance of your Vision System and Infrared Sensing System are affected by the surface being flown over. Ultrasonic sensors may not be able to accurately measure distances when operating above sound-absorbing materials and the camera may not function correctly in suboptimal environments. The aircraft will switch from P-mode to A-mode automatically if neither vision sensors nor ultrasonic sensors and Infrared Sensing System are available. Operate the aircraft with great caution in the following situations:
 - a) Flying over monochrome surfaces (e.g. pure black, pure white, pure red, pure green).
 - b) Flying over a highly reflective surfaces.
 - c) Flying at high speeds of over 31mph (50kph) at 2 meters or over 11mph (18kph) at 1 meter.
 - d) Flying over water or transparent surfaces.
 - e) Flying over moving surfaces or objects.
 - f) Flying in an area where the lighting changes frequently or drastically.
 - g) Flying over extremely dark (lux < 10) or bright (lux > 100,000) surfaces.
 - h) Flying over surfaces that can absorb sound waves (e.g. thick carpet).
 - i) Flying over surfaces without clear patterns or texture.
 - j) Flying over surfaces with identical repeating patterns or textures (e.g. tiling).
 - k) Flying over inclined surfaces that will deflect sound waves away from the aircraft.
 - l) Flying over obstacles with too small effective infrared reflective surface.
 - m) DO NOT position the sides of two aircraft toward each other to avoid interference between the 3D infrared modules.
 - n) DO NOT cover the protective glass of the infrared module. Keep it clean and undamaged.
 - o) Flying at high speed at low altitude (under 0.5 m).



- Keep sensors clean at all times. Dirt or other debris may adversely affect their effectiveness.
- Vision Positioning is only effective when the aircraft is at altitudes of 0.3 to 10 meters.
- The Vision Positioning may not function properly when the aircraft is flying over water.
- The Vision System may not be able to recognize pattern on the ground in low light conditions (less than 100 lux).
- Do not use other ultrasonic devices with frequency of 40 kHz when Vision System is in operation.

* This mode will be supported later.

RTK Functions

The aircraft has a built-in DJI Onboard D-RTK, which provides more accurate data for centimeter-level positioning to improve operation precision when using with the DJI D-RTK 2 High-Precision GNSS Mobile Station or Network RTK service. The onboard D-RTK, providing precision position and speed information combined with optimized algorithms, is more accurate than a standard compass sensor and functions even with magnetic interference from metal structures, ensuring stable flight. If the RTK signal is weak and differential data cannot be transmitted during a Photogrammetry or Waypoint Flight operation, users can read the raw satellite observations* recorded in the microSD card in the aircraft after the flight, and then use PPK technology to achieve centimeter-level positioning.

Enable/Disable RTK

Ensure that the "RTK Function" is enabled and RTK service type is correctly set (D-RTK 2 Mobile Station or Network RTK service) before each use. Go to Camera View in the DJI GS RTK app > ⋮ > RTK to view and set.

Make sure to disable RTK function if not in use. Otherwise, the aircraft will not be able to take off when there is no differential data.

Using with the DJI D-RTK 2 Mobile Station

1. Refer to the D-RTK 2 Mobile Station User Guide to complete linking between the aircraft and the mobile station and setup of the mobile station.
2. Power on the mobile station and wait for the system to start searching for satellites. The RTK status icon on top of the Camera View in the DJI GS RTK app will show  to indicate that the aircraft has obtained and used the differential data from the mobile station.



After enabling the RTK function and connecting to a data source, be sure to wait for the aircraft's RTK module to finish initializing and the RTK / GNSS signal strength icon in the app shows FIX so that the aircraft can take off.

Recording Input D-RTK 2 Coordinates

The DJI GS RTK app can record multiple coordinates of the D-RTK 2 Mobile Station input by users, making it easy to manage the input history for use in future missions.

1. After connecting to the D-RTK 2 Mobile Station, go to Advanced Settings in RTK Settings in the app.
2. Input a measured latitude, longitude and altitude of the D-RTK 2 Mobile Station in the corresponding text box and add notes for the coordinates. Note that the coordinates input should not be more than 50 m away from the actual location of the D-RTK 2 Mobile Station.
3. Tap Settings to write the coordinates into the D-RTK 2 Mobile Station. The coordinates will be recorded in the History list.
4. Tap Reset to clear the information in the text boxes.
5. Choose the item in the History list to fill the information in the text boxes. If the information in the text boxes has been changed, a new item will be generated after tapping the Settings button.
6. Tap Editing Mode in the History list to delete items in this mode.

* The raw satellite observations are stored in the same directory as the aerial photos. They will only be recorded during Photogrammetry or Waypoint Flight operations. For Waypoint Flight operations, route recording should be disabled in Route Settings. Otherwise, the raw satellite observations cannot be recorded. In other situations, such as flying the aircraft and shooting manually, the data will not be recorded.

Using with the Network RTK Service

The Network RTK service uses the remote controller instead of the base station to connect to an approved Network RTK server for differential data. Keep the remote controller on and connected to the Internet when using this function.

1. Ensure that the remote controller is connected to the aircraft and has access to the Internet.
2. Go to Camera View in the DJI GS RTK app > ●●● > RTK, select the RTK service type to custom network RTK, and then input the network information.
3. Wait for the remote controller to be connected with the Network RTK server. The RTK status icon on top of the Camera View in the DJI GS RTK app will show  to indicate that the aircraft has obtained and used the RTK data from the server.

Maintain Positioning Accuracy Mode

Maintain Positioning Accuracy mode keeps the aircraft in the RTK FIX status when RTK is not working properly, e.g. RTK is disconnected or receiving no satellite signals, so that the aircraft will not read a sudden change in positioning. This helps avoid flight hazards due to the change of the positioning accuracy. Follow the instructions below.

1. Make sure that the RTK module is working properly. In the DJI GS RTK app, enable Maintain Positioning Accuracy mode in RTK Settings.
2. There will be a prompt to show that the aircraft is entering Maintain Positioning Accuracy mode and a warning icon  will be shown in the status bar on top of the screen when RTK is abnormal. If Maintain Positioning Accuracy mode was disabled, the aircraft can also enter this mode when it is enabled after RTK is abnormal.
3. The warning icon in the status bar will disappear if the RTK signal source is reconnected within 10 min after the aircraft enters Maintain Positioning Accuracy mode and the RTK status is FIX after the reconnection.
4. If RTK signal source still cannot be reconnected after 10 min, the aircraft will automatically exit from RTK positioning and switch to GNSS positioning.







- If the aircraft never entered RTK FIX status before RTK is abnormal, it cannot enter Maintain Positioning Accuracy mode.
 - When the aircraft is in Maintain Positioning Accuracy mode, note:
 - a) The aircraft positioning accuracy will decrease gradually. Be sure to fly with caution. Stop the flight or reconnect to the RTK signal source immediately to avoid flight hazards.
 - b) Flying the aircraft for a long distance (for example, automatically performing operations alongside the planned flight route), or controlling the aircraft with a large stick movement will lead to faster positioning accuracy decrease.
 - c) The RtkFlag of the images the aircraft captured is 16, which cannot meet the requirements for mapping. It is not recommended to use Maintain Positioning Accuracy mode in flight route operations, especially in operations with an absolute altitude. This mode is more suitable for inspection or waypoint operations.
-

Flight Recorder

Flight data is automatically recorded to the internal storage of the aircraft. To access this data, connect the aircraft to the PC through the Micro USB port and launch the DJI Assistant 2.

Attaching and Detaching the Propellers

Use only DJI approved propellers with your aircraft. The grey and black ring on the propeller indicate where they should be attached and in which direction they should spin.

Propellers	Silver Ring	Black Ring
Figure		
Attach On	Motors without black dots	Motors with black dots
Legends	 Lock : Turn the propellers in the indicated direction to mount and tighten.  Unlock : Turn the propellers in the indicated direction to loosen and remove.	

Attaching the Propellers

1. Be sure to remove the warning stickers from the motors before attaching the propellers.
2. Mount the propellers with black propeller rings to the motors with black dots. Mount the propellers with silver propeller rings to the motors without black dots. Press the propeller down onto the mounting plate and rotate in the lock direction until it is secured in its position.

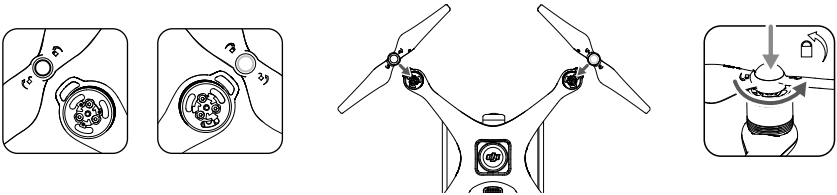

Detaching the Propellers

Press the propellers down into the motor mount and rotate in the unlock direction.



- Be aware of the sharp edges of the propellers. Handle with care.
- Use only the DJI approved propellers. Do not mix propeller types.
- Check that the propellers and motors are installed correctly and firmly before every flight.
- Ensure that all propellers are in good condition before each flight. **DO NOT** use aged, chipped, or broken propellers.
- To avoid injury, **STAND CLEAR** of and **DO NOT** touch propellers or motors when they are spinning.
- **ONLY** use original DJI propellers for a better and safer flight experience.

DJI Intelligent Flight Battery

The DJI Intelligent Flight Battery has a capacity of 5870 mAh, a voltage of 15.2 V, and a smart charge/discharge functionality. It should only be charged using an appropriate DJI approved power adapter and charging hub.

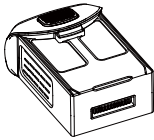

Intelligent Flight Battery

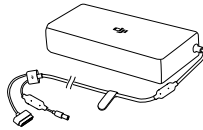

AC Power Adapter

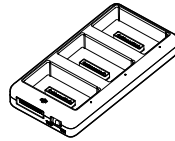

Charging Hub



- The Intelligent Flight Battery must be fully charged before using it for the first time.
 - Never insert or remove the battery when it is turned on.
 - Ensure the battery is mounted firmly. The aircraft will not take off if the battery is mounted incorrectly.
-

DJI Intelligent Flight Battery Functions

1. Battery Level Display: The LED indicators display the current battery level.
2. Auto-Discharging Function: To prevent swelling, the battery automatically discharges to below 65% of total power when it is idle for more than ten days. It takes around two days to discharge the battery to 65%. It is normal to feel moderate heat being emitted from the battery during the discharge process.
3. Balanced Charging: Automatically balances the voltage of each battery cell when charging.
4. Overcharge Protection: Charging automatically stops when the battery is fully charged.
5. Temperature Detection: The battery will only charge when the temperature is between 5°C (41°F) and 40°C (104°F).
6. Over Current Protection: The battery stops charging when a high amperage (more than 8 A) is detected.
7. Over Discharge Protection: To prevent over-discharge damage, discharging automatically stops when the battery voltage reaches 12 V.
8. Short Circuit Protection: Automatically cuts the power supply when a short circuit is detected.
9. Battery Cell Damage Protection: The DJI GS RTK app displays a warning message when a damaged battery cell is detected.
10. Sleep Mode: To save power, the battery enter sleep mode after 20 minutes of inactivity.
11. Communication: Information pertaining to the battery's voltage, capacity, current, etc. is transmitted to the aircraft's main controller.



Refer to Phantom 4 Series Intelligent Flight Battery Safety Guidelines before use. Users take full responsibility for all operations and usage.

Using the Battery

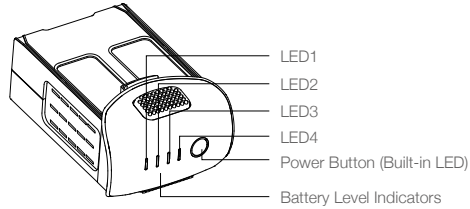

Turning ON/OFF

Turning On: Press the Power Button once, then press again and hold for 2 seconds to turn on. The Power LED will turn green and the Battery Level Indicators will display the current battery level.

Turning Off: Press the Power Button once, then press again and hold for 2 seconds to turn off. The battery power LED will flash when powering off the Phantom to allow automatically stopping of a recording during the event recording wasn't stopped.

Low Temperature Notice:

1. Battery capacity is significantly reduced when flying in low temperature ($< 0^{\circ}\text{C}$) environments.
2. It is not recommended that the battery be used in extremely low temperature ($< -10^{\circ}\text{C}$) environments. Battery voltage should reach the appropriate level when operating environment with temperatures between -10°C and 5°C .
3. End the flight as soon as the DJI GS RTK app displays the "Low Battery Level Warning" in low temperature environments.
4. Keep the battery indoors to warm it before flying in low temperature environments.
5. To ensure optimal performance of the battery, keep the battery temperature above 20°C .
6. The charger will stop charging the battery if the battery cell's temperature is not within the operating range ($0^{\circ}\text{C} \sim 40^{\circ}\text{C}$).

 In cold environments, insert the battery into the battery compartment and turn on the aircraft for approximately 1-2 minutes to warm up before taking off.

Checking the Battery Level

The Battery Level Indicators display how much power remains. When the battery is turned off, press the Power Button once. The Battery Level Indicators will light up to display the current battery level. See below for details.

 The Battery Level Indicators will also show the current battery level during charging and discharging. The indicators are defined below.

-  : LED is on.  : LED is flashing.
-  : LED is off.

Battery Level Indicators				
LED1	LED2	LED3	LED4	Battery Level
☐	☐	☐	☐	87.5%~100%
☐	☐	☐	⦿	75%~87.5%
☐	☐	☐	☐	62.5%~75%
☐	☐	⦿	☐	50%~62.5%
☐	☐	☐	☐	37.5%~50%
☐	⦿	☐	☐	25%~37.5%
☐	☐	☐	☐	12.5%~25%
⦿	☐	☐	☐	0%~12.5%
☐	☐	☐	☐	=0%

Charging the Intelligent Flight Battery



- Air cool the Intelligent Flight Battery after each flight. Allow its temperature to drop to room temperature before charging.
- The charging temperature range is 5° to 40° C. The battery management system will stop the battery from charging when the battery cell temperature is out of range.
- Always turn off the battery before inserting it or removing it from the aircraft. Never insert or remove a battery when it is turned on.

Using only the Power Adapter for Charging

1. Connect the AC power adapter to a power source (100-240 V 50/60 Hz).
2. Connect the Intelligent Flight Battery to the power adapter to start charging. If the battery level is above 95%, turn on the battery before charging.
3. The Battery Level Indicator will display the current battery level as it is charging.
4. The Intelligent Flight Battery is fully charged when the Battery Level Indicators are all off.

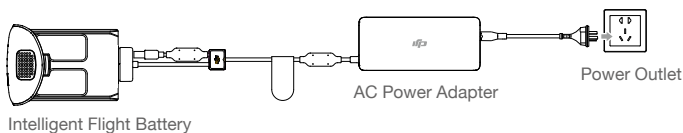

Battery Level Indicators While Charging				
LED1	LED2	LED3	LED4	Battery Level
⦿	☐	☐	☐	0%~25%
⦿	⦿	☐	☐	25%~50%
⦿	⦿	⦿	☐	50%~75%
⦿	⦿	⦿	⦿	75%~100%
☐	☐	☐	☐	Fully Charged

Using the Power Adapter and Charging Hub for Charging

1. Connecting to a Power Source

Connect the power adapter to a power outlet (100-240V, 50/60Hz), then connect the charging hub to the power adapter.

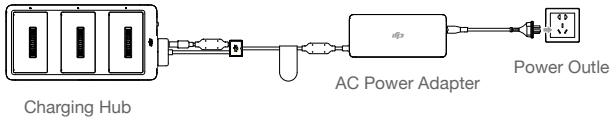

2. Connecting Batteries

Charging Mode:

Align the grooves on the Intelligent Flight Battery with the battery slot tracks to insert the battery and begin charging. The Intelligent Flight Battery with the highest power level will be charged first. Other batteries will be charged in sequence according to their power levels.

If the Status LED Indicator of the charging hub is solid green and the LED lights on the Intelligent Flight Battery turn off, charging is complete and the Intelligent Flight Battery can be disconnected from the charging hub.

Storage Mode:



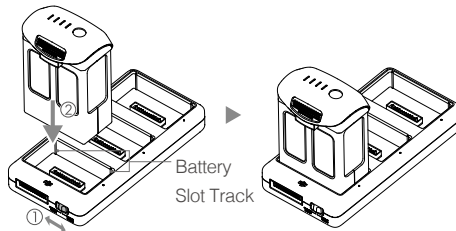







The charging hub will discharge batteries with more than 50% power to reduce the charge to 50%. Meanwhile batteries with less than 50% charge will be charged to 50%.



• Be sure to align the grooves on the Intelligent Flight Battery with the battery slot tracks. The Status LED Indicator will turn solid yellow if the battery is properly inserted.

























• In storage mode, you can power on the Intelligent Flight Batteries to discharge them without having to connect to a power source if all batteries have more than 50% power.

Status LED Indicator Description

Status LED Indicator	Description
Charging Mode	
 — Solid Yellow	Queuing to charge
 Blinking Green	Charging
 — Solid Green	Fully charged
 — Solid Red	No battery detected
 All Blinking Red	Power supply error, please check the connection to the Battery Charger
Storage Mode	
 — Solid Yellow	Ready to charge or discharge
 Blinking Blue	Charging or discharging
 — Solid Blue	The battery's power level is 50%
 — Solid Red	No battery detected
 All Blinking Red	Power supply error, please check the connection to the Battery Charger

Battery Protection LED Display

The table below shows battery protection mechanisms and corresponding LED patterns.

Battery Level Indicators while Charging					
LED1	LED2	LED3	LED4	Blinking Pattern	Battery Protection Item
				LED2 blinks twice per second	Over current detected
				LED2 blinks three times per second	Short circuit detected
				LED3 blinks twice per second	Over charge detected
				LED3 blinks three times per second	Over-voltage charger detected
				LED4 blinks twice per second	Charging temperature is too low
				LED4 blinks three times per second	Charging temperature is too high

After these issues are resolved, press the Power Button to turn off the Battery Level Indicator. Unplug the Intelligent Flight Battery from the charger and plug it back in to resume charging. Note that you do not need to unplug and plug in the charger in the event of a room temperature error; the charger will resume charging when the temperature is within the allowable range.



- DJI does not take any responsibility for damage caused by third-party chargers.
- If the battery level is above 95%, turn on the battery before charging.



How to discharge your Intelligent Flight Battery:

Place the Intelligent Flight Battery into the battery compartment and turn it on. Fly the aircraft out doors until the battery level is low (such as 20% of power left).

Remote Controller

This section describes the features of the remote controller and includes instructions for controlling the aircraft and the camera.

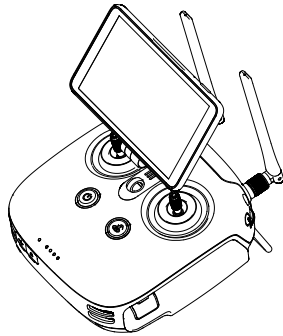

Remote Controller

Profile

The Phantom 4 RTK remote controller has a transmission range of up to 4.3 mi / 7 km (FCC-compliant version) with controls for camera tilt and photo capture. Built into the remote controller is the latest DJI OcuSync to enhance anti-interference ability for more stable and smoother video downlink. The remote controller includes a 5.5-inch high luminance monitor with integrated DJI GS RTK app for HD display. Users can plan flight paths and perform both Photogrammetry and Waypoint Flight operations in the app. The remote controller's Multi-Aircraft Control mode can be used to coordinate the operation of up to five aircraft at the same time, enabling pilots to work more efficiently.



- Compliance Version: The remote controller is compliant with local compliance and regulations.
- Stick Mode: Control can be set to Mode 1 or Mode 2, or to a custom mode.
- Mode 1: The right stick serves as the throttle.
- Mode 2: The left stick serves as the throttle.

Using the Remote Controller

Turning the Remote Controller On and Off

The remote controller uses a removable, interchangeable Intelligent Battery. The battery level is indicated via the Battery Level LEDs on the front panel after the battery is mounted. Follow the steps below to turn on your remote controller:

1. When the remote controller is turned off, press the Power button once to check the current battery level, indicated by the Battery Level LEDs. If the battery level is too low, recharge before use.
2. Press the Power button once. Then press and hold to turn on the remote controller.
3. The remote controller will beep when turned on. The Status LED will rapidly blink green, indicating that the remote controller is linking to the aircraft. They will glow solid green when linking is complete.
4. Repeat Step 2 to turn off the remote controller.

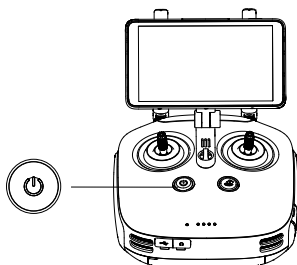

The remote controller internal backup battery allows users to insert and remove the external Intelligent Battery while the remote controller is still on and in use. The device will enter Sleep Mode to save power. Users are then required to replace the Intelligent Battery within three minutes, or the remote controller will power off.

Charging the Remote Controller

Charge the remote controller Intelligent Battery using the included AC power adapter and Charging Hub.

1. Place the battery into the Charging Hub, connect the AC power adapter to the Charging Hub, and then connect the charger to a power outlet (100-240V, 50/60Hz).
2. The Charging Hub will intelligently charge batteries in sequence according to battery power levels from high to low.
3. The Status LED blinks green when charging and turns solid green when fully charged. The buzzer will begin beeping when charging is complete. Remove the battery or turn off the buzzer to stop it.

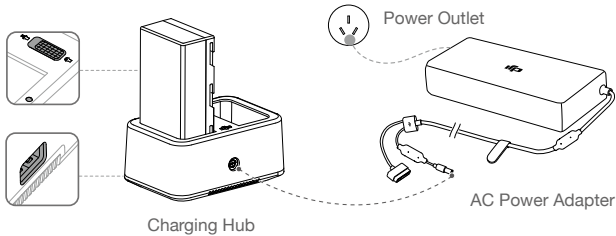

USB power supply port can be used to charge the mobile device of 5V/2A.

Status LED	Description
Blinks Green	Charging
Solid Green	Fully charged
Blinks Red	Battery Charger Error. Retry with an official battery charger.
Solid Red	Battery error
Blinks Yellow	Battery temperature too high/low. Temperature must be within operating range (5°-40°C)
Solid Yellow	Ready to charge
Alternating Green Blinks	Intelligent Battery not detected

Controlling the Camera

Shoot videos/photos, and adjust gimbal pitch angle via the Shutter Button, Record Button, and Gimbal Dial on the remote controller.

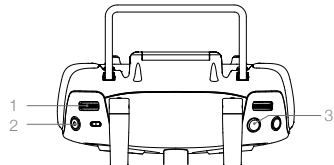

1. Gimbal Dial
Control the tilt of the gimbal. Turn left to tilt the gimbal upward and right to tilt the gimbal downward.
2. Video Recording Button
Press once to start recording video, then press again to stop recording.
3. Shutter Button
Press to take a photo.

Controlling the Aircraft

This section explains how to control the orientation of the aircraft through the remote controller. Control can be set to Mode 1, Mode 2 or Mode 3, or to a custom mode.

Mode 1

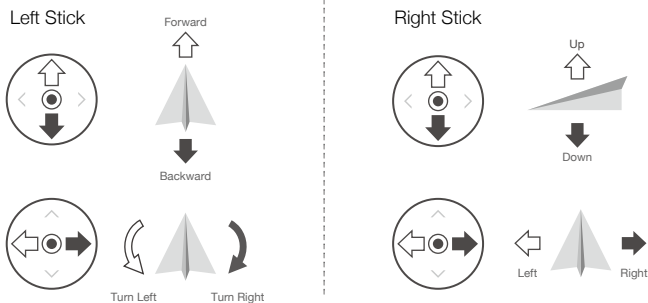

Mode 2

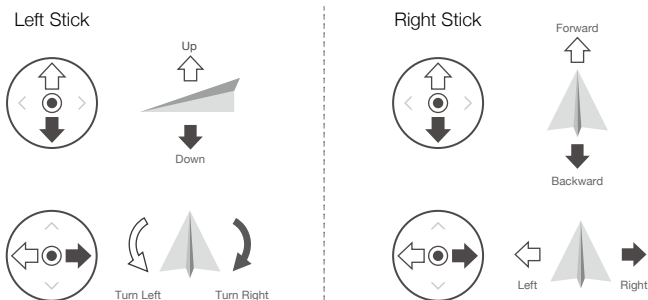

Mode 3

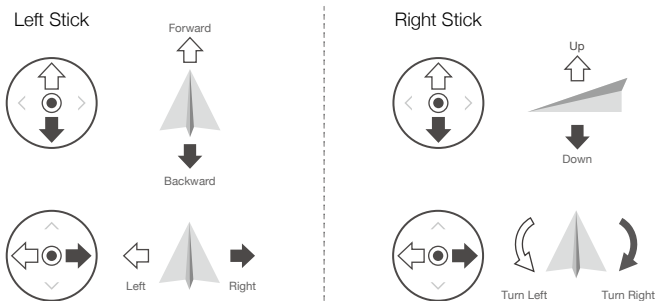





The Remote Control is set to Mode 2 by default.

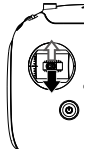
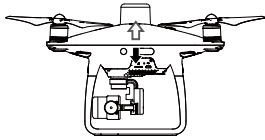
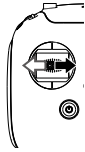

Stick Neutral/Mid-Point: Control sticks are in the center position.

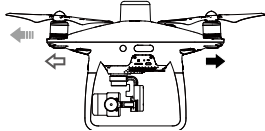
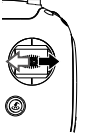
Moving the Control Stick: The control stick is pushed away from the center position.

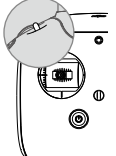
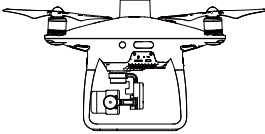
Remote Controller (Mode 2)	Aircraft (← Indicates Nose Direction)	Remarks
		<p>Moving the left stick up and down changes the aircraft's elevation.</p> <p>Push the stick up to ascend and down to descend. When both sticks are centered, the aircraft will hover in place.</p> <p>The more the stick is pushed away from the center position, the faster the aircraft will change elevation. Always push the stick gently to prevent sudden and unexpected elevation changes.</p>
		<p>Moving the left stick to the left or right controls the rudder and rotation of the aircraft.</p> <p>Push the stick left to rotate the aircraft counter-clockwise, push the stick right to rotate the aircraft clockwise. If the stick is centered, the aircraft will maintain its current orientation.</p> <p>The more the stick is pushed away from the center position, the faster the aircraft will rotate.</p>
		<p>Moving the right stick up and down changes the aircraft's forward and backward pitch.</p> <p>Push the stick up to fly forward and down to fly backward. The aircraft will hover in place if the stick is centered.</p> <p>Push the stick further away from the center position for a larger pitch angle (maximum 30°) and faster flight.</p>
		<p>Moving the right stick control left and right changes the aircraft's left and right pitch.</p> <p>Push left to fly left and right to fly right. The aircraft will hover in place if the stick is centered.</p>
		<p>During an automatic flight, toggle the Pause Switch to exit from the automatic flight. The aircraft will hover at the current position.</p>

Adjusting Controller Sticks

Hold and twist the controller sticks clockwise or counter clockwise to adjust the length of the controller sticks. A proper length of controller sticks can improve the controlling accuracy.

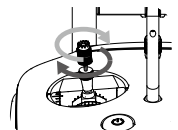

RTH Button

Press and hold the RTH button to start the Return to Home (RTH) procedure. The LED ring around the RTH Button will blink white to indicate that the aircraft is entering RTH mode. The aircraft will then return to the last recorded Home Point. Press this button again to cancel the RTH procedure and regain control of the aircraft.

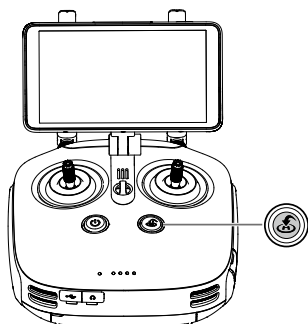

Optimal Transmission Range

The transmission signal between the aircraft and the remote controller is most reliable within the area that depicted below:

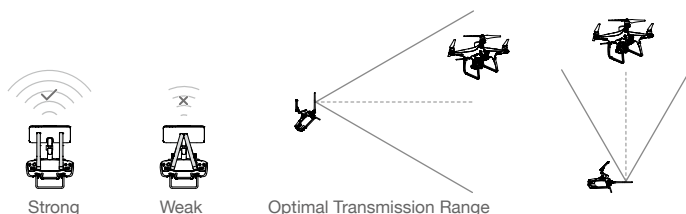







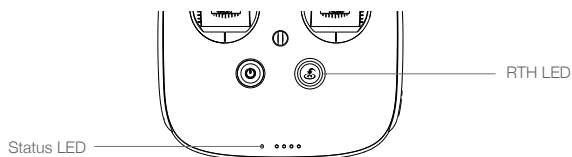





Ensure that the aircraft is flying within the optimal transmission zone. To achieve the best transmission performance, maintain the appropriate relationship between the operator and the aircraft.

Remote Controller Status LED

The Status LED reflects the strength of the connection between the remote controller and the aircraft. The RTH LED indicates the RTH status of the aircraft. The table below contains more information about these indicators.



Status LED	Alarm	Remote Controller Status
 — Solid Red	 Chime	The remote controller is disconnected from the aircraft.
 — Solid Green	 Chime	The remote controller is connected to the aircraft.
 Slow Blinking Red	D-D-D.....	Remote controller error.
 /  Red and Green/ Red and Yellow Alternate Blinks	None	HD downlink is disrupted.
RTH LED	Sound	Remote Controller Status
 — Solid White	 Chime	Aircraft is returning home.
 Blinking White	D . . .	Sending RTH command to the aircraft.
 Blinking White	DD	RTH procedure in progress.

 The Remote Controller Status Indicator will blink red and sound an alert, when the battery level is critically low.

Linking the Remote Controlle

The remote controller is linked to your aircraft by default. Linking is only required when using a new remote controller for the first time. If using Multi-Aircraft Control function, linking all the aircraft to the same remote controller is required.

1. Power on the remote controller and open the DJI GS RTK app. Power on the aircraft.
2. Tap Fly to enter Camera View and tap ●●● > . Select Aircraft as the linking device, tap Single Linking or Multi Linking (if Multi-Aircraft Control is in use), and then tap Pairing. The Status LED blinks blue and the remote controller sounds double beep repeatedly, indicating that the remote controller is ready for linking.

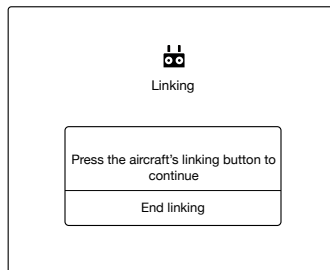

3. Press the Link button on the aircraft. Then release and wait for a few seconds.
4. The Status and Link LED will glow solid green if linking is successful. If the Link LED does not glow solid green, linking failure occurred. Enter linking status again and retry.
5. Repeat steps 3 and 4 to complete linking between all the aircraft (up to five) and the remote controller, if Multi Linking is selected. Then tap End linking.

Multi-Aircraft Control Function

The remote controller features Multi-Aircraft Control function which can be used to coordinate the operation of up to five aircraft at the same time, enabling pilots to work very efficiently. Turn the Aircraft Control Switch Dial on the remote controller to switch between different aircraft for single control of the desired aircraft.

-
-  When using the Multi-Aircraft Control function, to avoid interference among operation groups, do not operate more than three groups within a 50-meter radius. Unless using the Phantom 4 RTK with a DJI D-RTK 2 Mobile Station, it is necessary to manually configure each remote controller's serial number in the DJI GS RTK app.
-

Enter Multi-Aircraft Control Mode

1. Link all the aircraft (up to five) to the same remote controller according to the steps in “Linking the Remote Controller”.
2. Close the settings menu after linking. The linked aircraft will be listed on the left of the screen sorted by number.

Switch Control

Users can switch control among different aircraft via the aircraft status box on the left screen in the app or the Aircraft Control Switch Dial on the remote controller. The Front LEDs of the selected aircraft will be solid red while the Front LEDs of other aircraft will be solid yellow.





Switch in the App

Tap the status box of the corresponding number in the app. The side of the box will turn blue and the Front LEDs of the aircraft will blink red quickly, indicating the corresponding aircraft has been selected.

Switch by the Dial

1. Turn the Aircraft Control Switch Dial on the remote controller. There will be an arrow near the corresponding status box in the app, and the Front LEDs of the aircraft will blink yellow quickly, indicating the corresponding aircraft is in pre-selected status.
2. Press the dial once. The side of the box in the app will turn blue and the Front LEDs of the aircraft will blink red quickly for a few seconds and then turn to solid red, indicating the corresponding aircraft has been selected.

Multi-Aircraft Operations

1. Select the desired aircraft by switching control.
2. Tap the status box of the selected aircraft, then tap  on the left of the screen, or tap  on top of the screen to select and use an operation in the Plan tag. Perform the operation after setting operation parameters. The selected flight routes data will be uploaded to the aircraft.
3. Use an operation to each aircraft. Tap  to show the status boxes of all the aircraft and tap another status box to switch to the corresponding aircraft.
4. Tap Start after using operations for all the aircraft. Users can slide the sliders for each aircraft in the prompted window or slide the slider for all aircraft at the bottom position to take off all the aircraft and start operations at the same time.
5. If there is any emergency during operation, toggle the Pause Switch on the remote controller to brake all the aircraft. Then all operations will be paused and the aircraft will hover in place and can be controlled manually. To continue the operation, users should use the operation again in Executing tag in  icon.



During multi-aircraft operations, aircraft will automatically avoid each other based on positioning information. When the distance between aircraft is 15 m, they will slow down, and when the distance is 5 m, the aircraft will not be able to get any closer to each other.

Exit from Multi-Aircraft Control Mode

Users can exit from the mode through the following three methods.

Method 1: Link the remote controller to the only one desired aircraft according to the previous instructions (Single-Machine Pairing should be selected).

Method 2: Delete other aircraft and remain the only one aircraft in the Linked Aircraft list. So the remote controller can control this aircraft only.

Method 3: Power off the other aircraft that don't need control and power on the only one desired aircraft. So the remote controller can control this aircraft only. Note: if power on the other aircraft again, the remote controller and the linked aircraft will enter Multi-Aircraft Control mode automatically. Exit from this mode completely through method 1 or 2 if needed.

Gimbal and Camera

This section provides the technical specifications of the camera and explains the gimbal's operation modes.

Gimbal and Camera

Camera

Profile

The Phantom 4 RTK camera uses a 1-inch CMOS sensor with effective pixels of 20 M and a 24 mm (35 mm format equivalent) wide-angle lens. It is equipped with a blue glass filter to deliver enhanced picture quality and a UV lens for additional protection. An ND filter can be used when the operating environment is too bright.

The Phantom 4 RTK supports the capture of 4K at 30fps and a maximum video bitrate of 100 Mbps.

The 20 megapixel photos taken by Phantom 4 RTK is the result of the application of advanced image processing technique. A mechanical shutter with a 1/2000 max speed eliminates rolling shutter distortion when capturing stills of fast moving objects.

Camera Micro SD Card Slot

To store your photos and videos, insert the microSD card into the slot as shown below before turning on the aircraft. The Phantom 4 RTK comes with a 16 GB microSD card and supports microSD cards up to 128 GB. A UHS-1 and above microSD card is recommended due to their fast read and write speeds that support high-resolution video data. Users can read the photos and videos, and the raw satellite observations during Photogrammetry and Waypoint Flight operations from the microSD card.

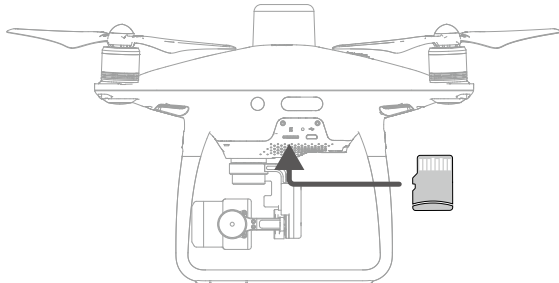

Do not remove the microSD card from the aircraft when it is shooting.



To ensure the stability of the camera system, single video recordings are capped at 30 minutes.

Micro USB Port

Turn on the aircraft and connect a Micro USB cable to the Micro USB Port to update firmware, read the photos and videos, and the raw satellite observations during Photogrammetry and Waypoint Flight operations.

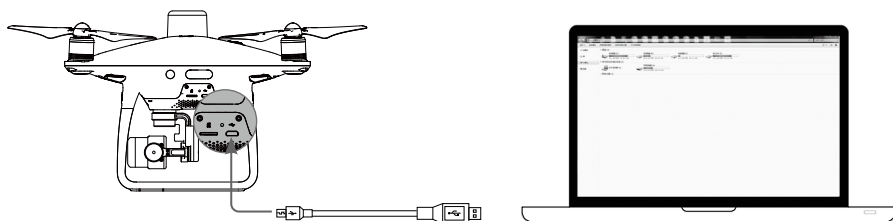











Camera Operation

Use the Shutter and Video Recording buttons on the remote controller or in the DJI GS RTK app to shoot the photos or videos.

Camera Status LED Indicator Descriptions

The Camera LED Indicator lights up after the flight battery is powered on. It provides information on the working status of the camera.

Camera LED Indicator	Camera status
 Green Fast Blink	System is warming up
 — Solid Green	The system is warmed up, the microSD card is inserted and working properly
 Green Blink Once	Taking a single picture
 Slow Red Blink	Recording
 Fast Red Blink	microSD card error
  x2 Double Red Blink	Overheated Camera
 — — Solid Red	System error
  Green and Red Blink	Firmware Upgrading

Gimbal

Profile



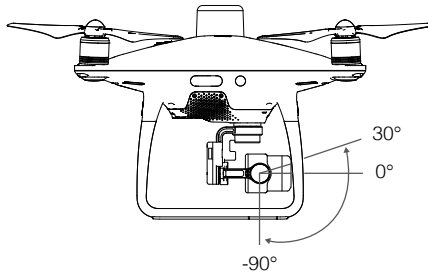

The 3-axis gimbal provides a steady platform for the attached camera, allowing you to capture clear, stable images and video. Turn the dial to adjust the gimbal pitch angle.

Controllable range of the pitch angle is -90° to $+30^{\circ}$. The default range is -90° to 0° . This can be adjusted in the DJI GS RTK app.



Gimbal Operation Modes

Two gimbal operation modes are available. Switch between the different operation modes on the gimbal settings page of the DJI GS RTK app. Refer to the table below for details:

	 <p>Follow Mode</p>	<p>The angle between the gimbal's orientation and aircraft's nose remains constant at all times.</p>
	 <p>FPV Mode</p>	<p>The gimbal will synchronize with the movement of the aircraft to provide a first-person perspective flying experience.</p>
	<ul style="list-style-type: none"> • A gimbal motor error may occur in these situations: <ol style="list-style-type: none"> (1) the aircraft is placed on uneven ground or the gimbal's motion is obstructed. (2) the gimbal has been subjected to an excessive external force, such as a collision. Please take off from flat, open ground and protect the gimbal at all times. • Flying in heavy fog or clouds may make the gimbal wet, leading to temporary failure. The gimbal will recover full functionality after it dries. • It is normal for the gimbal to produce a short beeping tone upon initialization. • In the case of less exposure time (no more than 1/200 second) or flight in S-mode with full remote controller stick movement, the aerodynamic vibration of the aircraft may increase due to aerodynamic forces. This can make the gimbal more susceptible to wind, causing photos to show a noticeable dynamic deformation (i.e., the "rolling shutter" effect). In such cases, it is suggested to increase the exposure time by using the filter or reducing the lens aperture, or reduce flying with smaller remote controller stick movement for better picture performance. 	

DJI GS RTK App

This section introduces the main functions of the DJI GS RTK app.

DJI GS RTK App

The DJI GS RTK app is designed for mapping applications. It can be used to plan operation areas and flight routes, set various parameters, and view the status of the operations in real time.

Main Screen

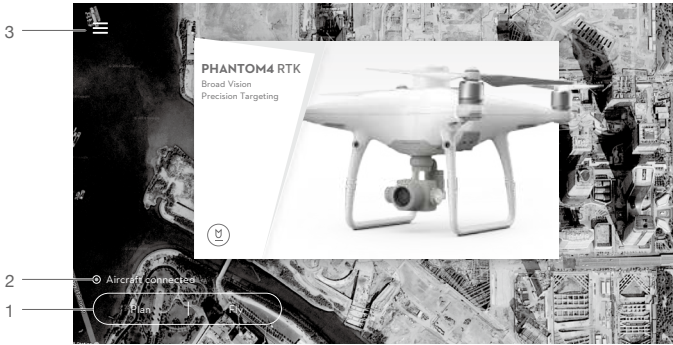

1. Plan a Field | Execute Operation

Plan: Tap the button and then select Photogrammetry or Waypoint Flight operation, and then enter Planning View for planning.

Fly: Tap to enter Camera View or Map View to view the aircraft status, configure the settings and perform operations.

2. Aircraft Connection Status

○ : Shows whether the aircraft is connected to the remote controller.

3. Menu

Tap **☰** to manage tasks, view user information, aircraft information, and configure general settings.

📅 : Task Management — View the progress of operations, planned operations and imported KML files.

👤 : User Info — View user information of the account logged in.

🔗 : Aircraft Info — View the information of the connected aircraft.

⚙️ : General Settings — Tap for settings such as units of measurement, network diagnosis, and Android system settings

Planning View

Photogrammetry



1. Main Screen

DJI: Tap this icon to return to the main screen.

2. Operation Type

Photogrammetry : Shows the current type of operation being planned.

3. Planning Information

Shows the mapping area, estimated flight time, and number of photos.

4. More Settings

Tap **⋮** to enter the extended menu to view and adjust the parameters of all other settings. Refer to the introduction for Camera View.

5. Location

📍 : Tap to center the map around the aircraft's location or the latest recorded Home Point.

6. Map Mode

🗺️ : Tap to switch among Standard, Satellite, or Night modes.

7. Operation Parameters Settings

This settings list will pop-up after edge points added by tapping on the map.

Height: The altitude of the aircraft during the operation.

Speed: The flight speed during the operation. The preset flight speed cannot exceed the maximum speed displayed above the Speed setting. The maximum speed is the flight speed at which images meeting mapping requirements can be captured and is calculated by the app according to current settings.

Relative Altitude: The relative height between the takeoff point and the operation area. The actual operation height is the aircraft height minus the relative height. **NOTE**: Make sure to set the correct relative height to ensure the results contain appropriate overlap rates.

Finish: The aircraft action after the operation is completed. Choose from RTH, hovering, landing, and back to the start point.

Camera Settings: Includes photo ratio, white balance, metering mode, gimbal angle, shutter priority and distortion correction.



- The default metering mode is average metering as it best serves mapping applications.
- If distortion correction is enabled, the image quality may be lower due to processing. It is recommended to disable this option when original images are need for post processing.

Advanced Settings: Includes horizontal overlapping rate, vertical overlapping rate and margin. The vertical overlapping rate indicates the overlapping rate of two pictures captured consecutively along the same path. The horizontal overlapping rate indicates the overlapping rate of two pictures on two parallel paths.

8. Map Zoom In/Out

⬆️: Tap to show the slider, and then slide it to zoom in or out.

9. Route Direction



The system automatically produces flight routes after adding edge points and setting parameters. Tap and drag this icon to adjust the flight direction of the produced route. Tap the icon for fine tuning in the pop-up menu.

The descriptions above use Photogrammetry operations as an example. Operations such as Terrain Awareness Mode, Block Segmentation and others have similar interfaces with Photogrammetry operations. For 3D Photogrammetry (Multi-oriented) operations, click the numbers 1 to 5 in the map view to preview each flight path. 1 refers to the nadir view flight path, and 2 to 5 refer to the four oblique flight paths respectively.

Waypoint Flight

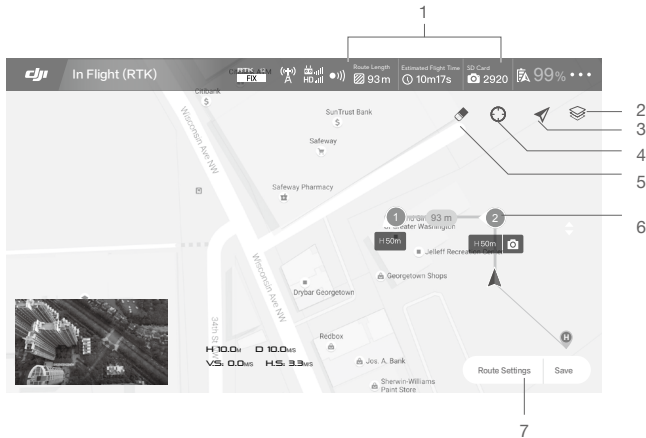

1. Planning Information

Shows the planned route length, estimated flight time, and microSD card capacity.

2. Map Mode

☁️: Tap to switch among Standard, Satellite, or Night modes.

3. Location Follow

📍: Tap to center the map around the aircraft's location at all times, following its location update.

4. Location

📍: Tap to center the map around the aircraft's location or the latest recorded Home Point.

5. Clear Screen

🧹: Tap to clear the flight path currently shown on the map.

6. Waypoints

📍: The waypoints added by pressing the C2 Button on the remote controller. Tap to set the flight altitude, heading, speed, gimbal angle and waypoint actions of each waypoint, switch among waypoints, and delete the waypoint.

7. Route Settings | Save

Route Settings: Tap to enter the route settings menu to set task ending action, remote controller signal loss action, aircraft heading in relevance to the flight route, cruising speed and route recording.

Other elements in this view are the same as the ones in Camera View.

Camera View

After tapping Fly in the main screen, users can switch between Camera View and Map View. The descriptions below use the Camera View as an example.

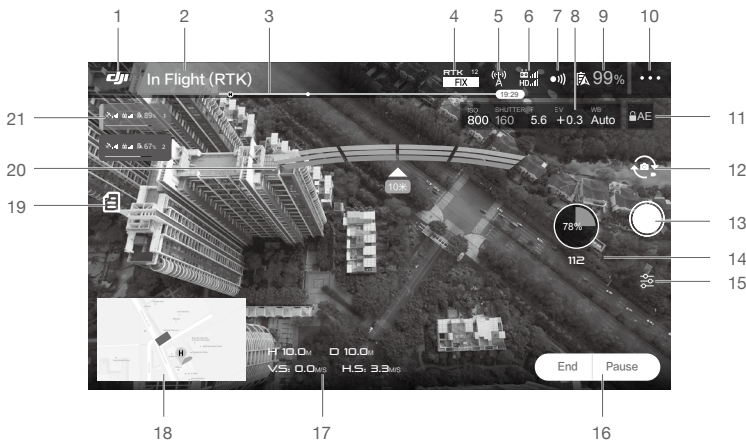

1. Main Screen

DJI: Tap this icon to return to the main screen.

2. Aircraft Status

In Flight (RTK): Indicates current flight modes and warning messages.

3. Battery Level Indicator

🔋: The battery level indicator provides a dynamic display of the battery level. The colored zones on the battery level indicator represent the power levels needed to carry out different functions.

4. RTK / GNSS Signal Strength

RTK 12: This icon is displayed once the RTK is enabled and begins working properly. The number on the upper right corner indicates the number of satellites connected. The RTK status below includes

two statuses: FIX indicates that differential data analysis is completed and RTK can be used for aircraft positioning. Only under this status can the aircraft take off. FLOAT indicates that differential data is in analysis. Waiting for it to be FIX is required.

 : This icon is displayed if the RTK is disabled, indicating the current GNSS signal strength and number of satellites connected.

5. RTK Data Source Status

Icons displayed when using RTK data. The display varies when using the D-RTK 2 or Network RTK Service.

 : Displays RTK signal strength when using the D-RTK 2.

 : Indicates that the connection with the D-RTK 2 is abnormal. Refer to the prompts in the app.

 : Displays RTK signal strength when using the Network RTK Service.

 : Indicates that the connection with the Network RTK server is abnormal. Refer to the prompts in the app.

6. Control and HD Video Link Signal Strength

 : Shows the signal strength of the control and HD video downlink connection between the aircraft and the remote controller.

7. Obstacle Sensing Function Status

 : Tap into this button to enable or disable features provided by the Vision System.

8. Camera Parameters

Displays camera settings parameters and capacity of the microSD card.

9. Battery Level

 99% : Shows the current battery level. Tap to set the Low Battery Warning threshold and view battery information.

10. More Settings

Tap  to enter the extended menu to view and adjust the parameters of all other settings.

 : Aircraft Settings — Includes Home Point settings, Return to Home Altitude, maximum altitude, distance limit, remote controller signal lost action, advanced settings, etc.

RTK:  : RTK Settings — Includes RTK function switch, RTK service type and their corresponding settings.

 : Sensor Settings — Includes enabling obstacle avoidance, radar map display, advanced vision settings, etc.

 : Remote Controller Settings — Includes remote controller calibration, stick mode, linking, etc.

HD : Image Transmission Settings — Includes channel mode and sweep frequency chart selection.

 : Aircraft Battery Settings — Includes low battery warning thresholds, battery information, etc. When a high discharge current, a short circuit, high or low discharge temperatures or battery cells damage is detected, there will be an on-screen prompt.

 : Gimbal Settings — Includes gimbal mode, advanced settings, gimbal roll adjustment, and auto gimbal calibration.

 : General Settings — Includes map settings, flight route display, to find aircraft, etc.

11. Auto Exposure Lock

 AE : Tap to lock the exposure value.

12. Photo/Video Button

 : Tap to switch between photo and video recording modes.

13. Shutter / Record Button

 : Tap to shoot photos or start/stop recording. When recording, the time code below the button indicates the length of the recording. Users can also press the Shutter or Video Recording button on the remote controller to shoot photos or record video.

14. Operation Progress

 : Shows the progress of the Photogrammetry operation and number of photos taken.

15. Camera Settings

 : Tap to set ISO, shutter, exposure values, OSD information, continuous auto focus (available for manual flying and shooting), etc.

16. Operation Control Buttons

Buttons to control during different operation types, including invoke, start, pause, or end an operation, etc.

17. Flight Parameters

H : Vertical distance from the aircraft to the Home Point.

D : Horizontal distance from the aircraft to the Home Point.

V.S : Movement speed across a vertical distance.

H.S : Movement speed across a horizontal distance.

18. Map

Tap the mini map to switch between Camera View and Map View. The icons  in Map View are the same as those in Planning View.

19. Operation List

 : Tap to view the planned operations, operations in progress and the imported KML files. Select Plan or Executing in the drop-down menu on top to use the operations. Select KML File to view and edit the data and use the data to plan the Photogrammetry operation area.

20. Obstacle Detection Status

Shows information on the detected obstacles when the obstacle avoidance function is enabled. Front obstacle information appears on the upper screen, and rear obstacle information appears on the lower screen. Red, orange, yellow, and green bars indicate the distance of obstacles in succession. The value indicates the distance between the aircraft and the nearest obstacle.

21. Aircraft Status Box in Multi-Aircraft Control Mode

Displays the status of all the connected aircraft sorted by number when using Multi-Aircraft Control function. Tap to switch the selected aircraft and the left side of the box will turn blue.

Cloud PPK Service

PPK is a post-processing differential correction technique that produces results with centimeter-level positioning accuracy. Unlike RTK (real-time kinematic), PPK records rover data and base station data separately to conduct post-process calculations and is therefore not restricted by the real-time communication link and protocols between the base station and the rover. In addition, PPK has a longer baseline distance than RTK, improving reliability. The DJI GS RTK app's Cloud PPK Service (premium add-on) supports multiple base station data sources, enabling users to connect to the cloud server for PPK calculations.

Purchase



Once purchased, the Cloud PPK Service will be bound to the aircraft SN. The app can only recognize operation data that corresponds to an aircraft SN with Cloud PPK Service activated.

Contact your local DJI authorized dealer to purchase an activation code for Cloud PPK Service.



In-app purchase is only supported in Mainland China. Users in other countries or regions can purchase the activation code of Cloud PPK Service from a dealer.

Activation

1. Connect the aircraft for which Cloud PPK Service has been purchased, or insert the microSD card that contains the operation data of the aircraft into the remote controller, so that the app can recognize the unique aircraft SN.
2. Go to the main screen of the app, tap  on the upper left corner, then , and select Cloud PPK Service to enter the settings menu, and tap Activate.
3. Read the Terms of Use and Privacy Policy carefully, and check the box to agree.
4. Input the activation code from the dealer.
5. Cloud PPK Service is available once activated.



Users can use Cloud PPK Service to calculate data collected before the activation if the firmware of the aircraft is v02.02.0312 or later.

Usage

Go to the Cloud PPK Service settings page. First, enable PPK Data Upload, and then tap START USING NOW to enter the Cloud PPK Service page. The page includes Account Information, Create Task, Current Tasks, and Past Tasks. In the Account Information tab, view the activated aircraft SN. In the Create Task tab, create tasks for PPK calculations. In Current Tasks and Past Tasks, view task progress and download PPK calculation results. The process is as follows:

1. Access PPK data from the aircraft:

Data storage path: The folder that contains the PPK data and signature file is the same folder where images of the flight tasks are stored. Make sure that the name of the folder is same as the task code of the data, for example, microSD card\DCIM\SURVEY\100_0005.

To import data: Insert the microSD card that contains the data into the remote controller. The app will recognize the folders in the card. Users can select data from one or multiple flight tasks in the app.



- Users can select the desired data in the Submitted tab if the aircraft PPK data has already been uploaded to the server.
- When users want to use aircraft PPK data with base station data from a RINEX base station, the RINEX base station data must be stored in: microSD card\third_base.

2. Make sure that the remote controller has access to the internet via a 4G dongle or Wi-Fi. In the Network Diagnostics page, check the status of the links and make sure the remote controller is connected to the DJI AG platform.
3. Go to the Cloud PPK Service page in the app.
4. Tap Create Task, and select one or more aircraft PPK source datasets. View details on the right side of the screen.

5. Tap Select Base Station Data to select the required base station data from the sources below.
- DJI Base Station: Set up the D-RTK 2 Mobile Station near the operation area to record the base station data when the aircraft performs operations. When finished, connect it to the remote controller using a USB-C OTG cable and a USB-C cable to access the data from it.
-

-  • If the latitude, longitude, and altitude of the base station was manually entered when setting up the D-RTK 2 Mobile Station, the input values will be used as the reference position. If the D-RTK 2 Mobile Station loses power during the operation but, once restarted, is within 5 m from the initial position, the initial position will be used. If it moves further than 5 m, the single point positioning (SPP) location of the D-RTK 2 Mobile Station will be used as the reference point.
- If no coordinates are entered, the D-RTK 2 Mobile Station will use the SPP location as the reference point.
-

RINEX base station: Insert the microSD card with the RINEX base station data stored in the path "microSD card\third_base" into the remote controller. Select datasets in the app, and manually input the base station coordinates or select the single point positioning (SPP) as the reference point.

6. Tap Start Calculations, and then wait for the calculations to finish.
7. Tap Current Tasks to view the data processing progress.
8. Tap Past Tasks to view and download the results of completed tasks. The downloaded data will be stored in the corresponding flight mission folder.
-

-  Users can import the PPK result file to DJI Terra for 2D or 3D reconstructions to improve accuracy. Refer to the DJI Terra User Manual for more details.
-



Flight

This section describes safe flight practices and flight restrictions.

Flight

Once the pre-flight preparation is complete, it is recommended to hone your flight skills through training and practice flying safely. The altitude limit is 1,640 feet (500 meters). Avoid flying at any altitudes higher. It is important to understand basic flight guidelines for the safety of both you and those around you. Refer to the Disclaimer and Safety Guidelines for more information.

Flight Environment Requirements

1. Do not use the aircraft in severe weather conditions. These include wind speeds exceeding 10 m/s, snow, rain and fog.
2. Only fly in open areas. Tall structures and large metal structures may affect the accuracy of the on-board compass and GNSS system.
3. Avoid obstacles, crowds, high voltage power lines, trees, and bodies of water.
4. Minimize interference by avoiding areas with high levels of electromagnetism, including base stations and radio transmission towers.
5. Aircraft and battery performance is subject to environmental factors such as air density and temperature. Be very careful when flying at altitudes greater than 19,685 feet (6000 meters) above sea level, as the performance of the battery and aircraft may be affected.
6. In the Earth's polar regions the aircraft can only operate in Attitude mode or using vision positioning.

GEO (Geospatial Environment Online) System

Introduction

DJI's Geospatial Environment Online (GEO) System is a global information system committed to providing real-time airspace information within the scope of international laws and regulations. GEO provides flight information, flight times and location information to assist Unmanned Aerial Vehicle (UAV) users in making the best decisions related to their personal UAV use. It also includes a unique Regional Flight Restrictions feature which provides real-time flight safety and restriction updates and blocks UAVs from flying in restricted airspace. While safety and obeying air traffic control laws is a paramount concern, DJI recognizes the need for exceptions to be made under special circumstances. To meet this need, GEO also includes an Unlocking feature that enables users to unlock flights within restricted areas. Prior to making their flight, users must submit an unlock request based on the current level of restrictions in their area.

GEO Zones

DJI's GEO System designates safe flight locations, provides risk levels and safety concerns for individual flights, and offers restricted airspace information, which can be viewed by users in real time on the DJI GS RTK app. The locations designated by GEO are called GEO Zones. GEO Zones are specific flight areas that are categorized by flight regulations and restrictions. GEO Zones that prohibit flight are implemented around locations such as airports, power plants, and prisons. They can also be temporarily implemented around major stadium events, forest fires, or other emergency situations. Certain GEO Zones do not prohibit flight but do trigger warnings informing users of potential risks. All restricted flight areas are referred to as GEO Zones, and are further divided into Warning Zones, Enhanced Warning Zones, Authorization Zones, Altitude Zones, and Restricted Zones. By default, GEO limits flights into or taking off within zones that may result in safety or security concerns. There is a GEO Zone Map, which contains comprehensive global GEO Zone information on the official DJI website: <https://www.dji.com/flysafe>.

The GEO System is for advisory purposes only. Individual users are responsible for checking official sources and determining which laws or regulations may apply to their flight. In some instances, DJI has selected widely-recommended general parameters (such as a 1.5-mile radius at airports) without making any determination as to whether these guidelines match regulations that apply to specific users.

GEO Zone Definitions

Warning Zones: Users receive a warning message with information relevant to their flight.

Enhanced Warning Zones: Users receive a prompt from the GEO System at the time of flight. They are required to submit an unlock request to fly in the zone, for which they must confirm their flight path.

Authorization Zones: Users receive a warning message and the flight is prohibited by default. Authorization Zones can be unlocked by authorized users with a DJI-verified account. Self-Unlocking privileges must be applied for online.

Altitude Zones: Flights are limited to a specific altitude.

Restricted Zones: Flights are completely prohibited. UAVs cannot fly in these zones. If you have obtained permission to fly in a Restricted Zone, please go to <https://www.dji.com/flysafe> or contact flysafe@dji.com to unlock the zone.

DJI GEO Zones aim to ensure the user's flight safety, but it cannot be guaranteed to be in full compliance with local laws and regulations. Users should check local laws, regulations, and regulatory requirements before each flight and are responsible for the flight safety.

All intelligent flight features will be affected when DJI aircraft fly nearby or into GEO Zones. Such interference includes, but is not limited to, decreased speed, takeoff failure, and flight termination.

Flight Restrictions

Introduction

UAV operators should abide by all flight regulations established by the relevant government and regulatory agencies, including the ICAO and the FAA. For safety reasons, flights are restricted by default, which helps users operate DJI products safely and legally. Flight restrictions include altitude and distance limits, and GEO Zones.

When Global Navigation Satellite Service (GNSS) is available, altitude limits, distance limits, and GEO Zones are all taken into account to ensure flight safety. Otherwise, only altitude limits take effect.

Maximum Altitude & Radius Restrictions

Maximum flight altitude restricts an aircraft's flight altitude, while maximum radius restricts its distance. These limits can be set using the DJI GS RTK app.

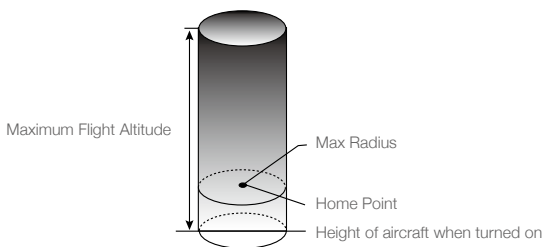

Strong GNSS Signal		
Restriction	Description	DJI GS RTK App Message
Max Altitude	Aircraft's altitude cannot exceed the specified value.	Maximum Flight Altitude reached. Adjust your altitude using Aircraft Settings if required.
Max Radius	Flight distance cannot exceed the specified value.	Maximum Flight Distance reached. Adjust your distance using Aircraft Settings if required.

Weak GNSS Signal		
Restriction	Description	DJI GS RTK App Message
Max Altitude	Altitude is restricted to 26 ft (8 m) when GNSS signal is weak and the Vision System is activated. Altitude is restricted to 98 ft (30 m) when GNSS signal is weak and the Vision System is deactivated.	Maximum Flight Altitude reached. Adjust your altitude using Aircraft Settings if required.
Max Radius	No limit.	N/A

- When an aircraft exceeds a specified limit, the pilot can still control the aircraft but it will be unable to fly any farther.
- When an aircraft exceeds the max radius it automatically flies back within range when GNSS signal is strong.
- For safety reasons, do not fly near airports, highways, railway stations, railway lines, city centers, or other sensitive areas. Only fly aircraft in areas that are within your direct line of sight.

GEO Zone Flight Restrictions

GEO Zone	Description
Restricted Zone	Takeoff: The aircraft's motors cannot be started.
	In-flight: When GNSS signal changes from weak to strong, DJI GS RTK starts a 20-second countdown. Once the countdown is over, the aircraft immediately lands in semi-automatic descent mode and turns off its motors after landing.
	In-flight: When the aircraft approaches the boundary of the Restricted Zone, it automatically decelerates and hovers.
Authorization Zone	Takeoff: The aircraft's motors cannot be started. Takeoff is only available after submitting an unlock request with the user's phone number.
	In-flight: When GNSS signal changes from weak to strong, DJI GS RTK starts a 20-second countdown. Once the countdown is over, the aircraft immediately lands in semi-automatic descent mode and turns off its motors after landing.
Enhanced Warning Zone	The aircraft flies normally but the user is required to confirm the flight path.
Warning Zone	The aircraft flies normally but the user receives warning messages.
Altitude Zone	When GNSS signal is strong, the aircraft cannot exceed the specified altitude. In-flight: When GNSS signal changes from weak to strong, the aircraft will descend and hover below the altitude limit.
	When the GNSS signal is strong, the aircraft approaches the boundary of the Altitude Zone. If it is higher than the altitude limit, the aircraft decelerates and hovers in place.
	When the GNSS signal changes from weak to strong, DJI GS RTK app starts a 20-second countdown. Once the countdown is over, the aircraft will descend and hover below the altitude limit.
Free Zone	The aircraft flies normally with no restrictions.

GEO Unlocking

Due to differing laws and regulations between countries and regions, and differing flight restrictions between GEO Zones, DJI provides users with two methods for unlocking GEO Zones: Self-Unlocking and Custom Unlocking.

Self-Unlocking is used for Authorization Zones, where the user is required to submit an unlock request by authenticating their phone number for a registered DJI account. This feature is only available in certain countries. Users can choose whether to submit their unlock request via the website at <https://www.dji.com/flysafe> (Scheduled Self-Unlocking), or through the DJI GS RTK app (Live Self-Unlocking).

Custom Unlocking is based on special requirements for individual users. It sets a special flight

area that users can unlock by providing flight permission files according to their specific GEO Zone and other requirements. It is available in all countries and can be applied for on the website: <https://www.dji.com/flysafe>.

For more information about unlocking, please visit <https://www.dji.com/flysafe> or contact flysafe@dji.com.

Preflight Checklist

1. Remote controller, Intelligent Flight Battery are fully charged.
2. Propellers are mounted correctly and firmly.
3. MicroSD card has been inserted.
4. Gimbal and camera are functioning normally.
5. Motors can start and are functioning normally.
6. The DJI GS RTK app is successfully connected to the aircraft.
7. Ensure that the sensors for the Vision System and Infrared Sensing System are clean.

Calibrating the Compass

Only calibrate the compass when the DJI GS RTK app or the status indicator prompt you to do so. Observe the following rules when calibrating your compass:

-  DO NOT calibrate your compass where there is a chance of strong magnetic interference, such as magnetite, parking structures, and steel reinforcements underground.
- DO NOT carry ferromagnetic materials with you during calibration such as cellular phones.
- The DJI GS RTK app will prompt you to resolve the compass issue if the compass is affected by strong interference after calibration is complete. Follow the prompted instructions to resolve the compass issue.

Calibration Procedures

Choose an open area to carry out the following procedures.

1. Tap the Aircraft Status Bar in the app and select "Calibrate", then follow the on-screen instructions.
2. Hold the aircraft horizontally and rotate 360 degrees. The Aircraft Status Indicators will display a solid green light.
3. Hold the aircraft vertically, with nose pointing downward, and rotate it 360 degrees around the center axis.

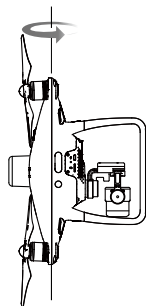
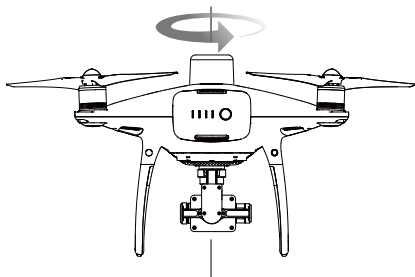

4. Re-calibrate the aircraft if the aircraft status indicators glows blinking red.

- ⚠️ • If the Aircraft Status Indicator blinks red and yellow after the calibration procedure, move your aircraft to a different location and try again.
-
- ☀️ • DO NOT calibrate the compass near metal objects such as a metal bridge, cars, scaffolding.
 - If the aircraft status indicators are blinking red and yellow alternately after placing the aircraft on the ground, the compass has detected magnetic interference. Change your location.

Starting/Stopping the Motors

Starting the Motors

A Combination Stick Command (CSC) is used to start the motors. Push both sticks to the bottom inner or outer corners to start the motors. Once the motors have started spinning, release both sticks simultaneously.

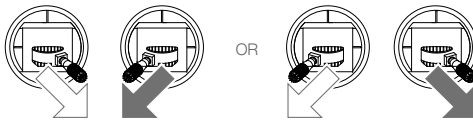

Stopping the Motors

There are two methods to stop the motors.

Method 1: When the aircraft has landed, push the left stick down ①, then conduct the same CSC that was used to start the motors, as described below ②. Motors will stop immediately. Release both sticks once motors stop.

Method 2: When the aircraft has landed, push and hold the left stick down. The motors will stop after three seconds.

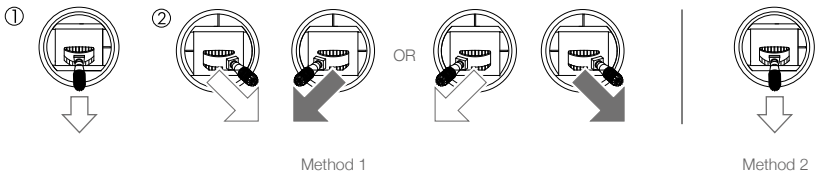

Stopping Motors Mid-flight

Perform the CSC to stop the motors. It can be enabled in the app. Go to Camera View > ●●● > ⚙️ > Advanced Settings to set the Urgent Stop Mode. Only stop motors mid-flight in emergency situations when doing so can reduce the risk of damage or injury.

Flight Test

Takeoff/Landing Procedures

1. Place the aircraft in an open, flat area with the battery level indicators facing towards you.
2. Turn on the remote controller and then turn on the Intelligent Flight Battery.
3. Launch the DJI GS RTK app and tap Fly.
4. Wait until the Aircraft Status Indicators start to blink green slowly, which indicates that GNSS or RTK is in use. If using RTK, ensure that the RTK function is enabled and that the RTK/GNSS signal strength icon shows FIX. Then perform CSC to start motors.
5. Push the left stick up slowly to take off.
6. To land, hover over a level surface and gently pull down on the left stick to descend.
7. After landing, hold the left stick at its lowest position until the motors stop.
8. Turn off the Intelligent Flight Battery first, then the remote controller.



- When the Aircraft Status Indicators blink yellow rapidly during flight, the aircraft has entered Failsafe mode.
 - A low battery level warning is indicated by the Aircraft Status Indicators blinking red slowly or rapidly during flight.
 - Watch our video tutorials for more flight information.
-

Video Suggestions and Tips

1. Go through the full pre-flight checklist before each flight.
2. Select the desired gimbal operation mode in the app.
3. Only shoot photos or record videos when flying in P-mode.
4. Always fly in good weather conditions and avoid flying in rain or heavy wind. An ND filter can be used when the operating environment is too bright.
5. Choose the camera settings that suit your needs. Settings include ISO, exposure values, etc.
6. Perform flight tests to establish flight routes and preview scenes.
7. Push the control sticks gently to keep the aircraft's movement smooth and stable.



It is important to understand basic flight guidelines, for the safety of both you and those around you. Do not forget to read the Disclaimer and Safety Guidelines.

DJI Assistant 2 for Phantom

This section introduces the usage of the DJI Assistant 2 for Phantom software.

DJI Assistant 2 for Phantom

Update firmware, copy flight records and calibrate the Vision System in the DJI Assistant 2 for Phantom software. For users that own DJI Agras aircraft, the DJI Assistant 2 for MG can also be used for the functions above.

Installation and Launching

1. Download the software installation file from the Phantom 4 RTK download page:
<http://www.dji.com/phantom-4-rtk/info#downloads>
2. Install the software.
3. Launch DJI Assistant 2 for Phantom.

Using DJI Assistant 2 for Phantom

Connecting the Aircraft

Connect the Micro USB port of the aircraft to your computer with a Micro USB cable. Then power on the aircraft.



Be sure to remove the propellers before using DJI Assistant 2 for Phantom.

Firmware Update

A DJI account is required for firmware updates. Login with your DJI account or register for one.

Data Upload

Save the flight data recorded by the flight controller or the system logs to a local path or upload them.

Flight Data

Click Open Data Viewer to view flight data. Data Viewer is used to view and analyze the flight data files of the aircraft for performance analysis and troubleshooting.

Calibration

Calibrate the Vision System here when the app prompts for calibration.

Connecting the Remote Controller

Connect the USB-C port of the remote controller to your computer with a USB-C cable. Then power on the remote controller.

Firmware Update

A DJI account is required for firmware updates. Login with your DJI account or register for one. For the Phantom 4 RTK Remote Controller, the firmware can only be updated using DJI Assistant 2 if the firmware is v02.01.0012 or earlier.



- DO NOT power off the remote controller during the update.
 - DO NOT perform the firmware update while the aircraft is in the air. Only carry out the firmware update when the aircraft is on the ground.
 - The remote controller may become unlinked from the aircraft after the firmware update. Relink the remote controller and aircraft if necessary.
-

Appendix

Appendix

Specifications

Aircraft	
Weight (Battery & Propellers Included)	1391 g
Diagonal Size (Excluding Propellers)	350 mm
Max Ascent Speed	6 m/s (automatic flight); 5 m/s (manual control)
Max Descent Speed	3 m/s
Max Speed	31 mph (50 kph) (P-mode); 36 mph (58 kph) (A-mode)
Max Tilt Angle	25° (P- mode); 35° (A-mode)
Max Angular Speed	150°/s (A-mode)
Max Service Ceiling Above Sea Level	19685 ft (6000 m)
Max Wind Speed Resistance	10 m/s
Max Flight Time	Approx. 30 minutes
Operating Temperature	32° to 104° F (0° to 40° C)
Operating Frequency	2.400 GHz to 2.483 GHz (Europe, Japan, Korea) 5.725 GHz to 5.850 GHz (United States, China)
EIRP	2.4 GHz CE (Europe) / MIC (Japan) / KCC (Korea): < 20 dBm 5.8 GHz FCC (United States) / SRRC (Mainland China) / NCC (Taiwan, China): < 26 dBm
Hover Accuracy Range	RTK enabled and functioning properly: Vertical: ±0.1 m; Horizontal: ±0.1 m RTK disabled: Vertical: ±0.1 m (with vision positioning); ±0.5 m (with GNSS positioning) Horizontal: ±0.3 m (with vision positioning); ±1.5 m (with GNSS positioning)
Image Position Offset	The position of the camera center is relative to the phase center of the onboard D-RTK antenna under the aircraft body's axis: (36, 0, and 192 mm) already applied to the image coordinates in Exif data. The positive x, y, and z axes of the aircraft body point to the forward, rightward, and downward of the aircraft, respectively.
GNSS	
Single-Frequency High-Sensitivity GNSS	GPS + BeiDou + Galileo (Asia); GPS + GLONASS + Galileo (other regions)

* Supported later.

Multi-Frequency Multi-System High-Precision RTK GNSS	<p>Frequency Used GPS: L1/L2; GLONASS: L1/L2; BeiDou: B1/B2; Galileo: E1/E5 First-Fixed Time: < 50 s Positioning Accuracy: Vertical 1.5 cm + 1 ppm (RMS); Horizontal 1 cm + 1 ppm (RMS). 1 ppm indicates error with a 1 mm increase over 1 km of movement. Velocity Accuracy: 0.03 m/s</p>
Mapping Functions	
Mapping Accuracy*	Mapping accuracy meets the requirements of the ASPRS Accuracy Standards for Digital Orthophotos Class III.
Ground Sample Distance (GSD)	(H/36.5) cm/pixel, H indicates the aircraft altitude relative to the shooting scene (unit: m)
Acquisition Efficiency	Max operating area of approx. 1 km ² for a single flight (at an altitude of 182 m, i.e., GSD is approx. 5 cm/pixel, meeting the requirements of the ASPRS Accuracy Standards for Digital Orthophotos Class III).
Gimbal	
Stabilization	3-axis (pitch, roll, yaw)
Controllable Range	Pitch: -90° to +30°
Max Controllable Angular Speed	Pitch: 90°/s
Angular Vibration Range	±0.02°
Vision System	
Velocity Range	≤ 31 mph (50 kph) at 6.6 ft (2 m) above ground with adequate lighting
Altitude Range	0 - 33 ft (0 - 10 m)
Operating Range	0 - 33 ft (0 - 10 m)
Obstacle Sensory Range	2 - 98 ft (0.7 - 30 m)
FOV	Forward/Rear: 60° (horizontal), ±27° (vertical) Downward: 70° (front and rear), 50° (left and right)
Measuring Frequency	Forward/Rear: 10 Hz; Downward: 20 Hz
Operating Environment	Surfaces with clear patterns and adequate lighting (> 15 lux)
Infrared Sensing System	
Obstacle Sensory Range	0.6 - 23 ft (0.2 - 7 m)
FOV	70°(Horizontal), ±10°(Vertical)
Measuring Frequency	10 Hz
Operating Environment	Surface with diffuse reflection material, and reflectivity > 8% (such as wall, trees, humans, etc.)
Camera	
Sensor	1" CMOS; Effective pixels: 20M

* The actual accuracy depends on surrounding lighting and patterns, aircraft altitude, mapping software used, and other factors when shooting.

Lens	FOV (Field of View) 84°, 8.8 mm (35 mm format equivalent: 24 mm), f/2.8 - f/11, auto focus at 1 m - ∞
ISO Range	Video: 100 - 3200 (Auto), 100 - 6400 (Manual) Photo: 100 - 3200 (Auto), 100 - 12800 (Manual)
Mechanical Shutter	8 - 1/2000 s
Electronic Shutter	8 - 1/8000 s
Max Image Size	4864×3648 (4:3); 5472×3648 (3:2)
Still Photography Modes	Single shot
Video Recording Modes	H.264, 4K: 3840×2160 30p
Max. Bitrate Of Video	100 Mbps
Photo	JPEG
Video	MOV
Supported File Systems	FAT32 (≤ 32 GB); exFAT (> 32 GB)
Operating Temperature	32° to 104° F (0° to 40° C)
Remote Controller	
Operating Frequency	2.400 GHz to 2.483 GHz (Europe, Japan, Korea) 5.725 GHz to 5.850 GHz (United States, China)
EIRP	2.4 GHz CE / MIC / KCC: < 20 dBm 5.8 GHz SRRC / NCC / FCC: < 26 dBm
Max Transmission Distance	FCC / NCC: 4.3 mi (7 km); CE / MIC / KCC / SRRC: 3.1 mi (5 km) (Unobstructed, free of interference)
Power Consumption	16 W (typical value)
Display Device	5.5 inch screen, 1920×1080, 1000 cd/m ² , Android system, 4G RAM + 16G ROM
Operating Temperature	32° to 104° F (0° to 40° C)
Intelligent Flight Battery (PH4-5870mAh-15.2V)	
Capacity	5870 mAh
Voltage	15.2 V
Battery Type	LiPo 4S
Energy	89.2 Wh
Net Weight	468 g
Operating Temperature	14° to 104° F (-10° to 40° C)
Max Charging Power	160 W
Intelligent Flight Battery Charging Hub (P4CH)	
Voltage	17.5 V
Operating Temperature	41° to 104° F (5° to 40° C)

Remote Controller Intelligent Battery (WB37-4920mAh-7.6V)

Capacity	4920 mAh
Voltage	7.6 V
Battery Type	LiPo 2S
Energy	37.39 Wh
Operating Temperature	-4° to 104° F (-20° to 40° C)

Intelligent Battery Charging Hub (WCH2)

Input Voltage	17.3 to 26.2 V
Output Voltage and Current	8.7 V, 6 A; 5 V, 2 A
Operating Temperature	41° to 104° F (5° to 40° C)

AC Power Adapter (PH4C160)

Voltage	17.4 V
Rated Power	160 W

Updating the Firmware

Users can update the firmware in the DJI Assistant 2 for Phantom. The DJI GS RTK app can also be used to update the firmware of both the aircraft and remote controller, if using a firmware version of 01.04.0330 or above. Follow the instructions below.

1. Power on the remote controller and the aircraft. Ensure that the remote controller has access to the Internet.
2. Connect the USB-C port on the remote controller to the Micro USB port on the aircraft via a USB-C OTG cable and a Micro USB cable.
3. There will be a prompt on the lower right corner in the DJI GS RTK app if there is new firmware. Tap the text to enter firmware page.
4. Select the desired firmware and tap Update to enter firmware information page.
5. Tap Download XXX (XXX indicates the firmware version) to download the firmware package for all the devices.
6. When the download is complete, tap Update XXX under each device to enter the update page for the corresponding device, then tap Install and wait for the update complete.
7. After successfully completing the update, restart the remote controller and the aircraft manually.



- The battery level should be above 30% for the firmware update.
- The remote controller and the aircraft will restart automatically during firmware update. Be sure to keep the connection between the remote controller and the aircraft. DO NOT operate them manually until the app indicates installation is completed.
- The remote controller may become unlinked from the aircraft after the firmware update. Relink the remote controller and aircraft if necessary.
- Users can also update the firmware of the Phantom 4 RTK Remote Controller using a microSD card. Visit <https://www.dji.com/phantom-4-rtk/info#downloads> for more information about updating firmware and to download the latest firmware.

FAR Remote ID Compliance Information

The aircraft complies with the requirements of 14 CFR Part 89:

- The aircraft automatically broadcasts Remote ID messages from takeoff to shut down. An external device such as a cell phone or tablet is required to be connected as a location source to the SDK Remote Controller, and must run the DJI flight control app in the foreground and always allow the DJI flight control app to obtain its accurate location information. The connected external device must minimally be one of the following:
 - 1) FCC Certified personal wireless device that uses GPS with SBAS (WAAS) for location services; or
 - 2) FCC Certified personal wireless device with integrated GNSS.Also, the external device must be operated in a way that does not interfere with the location reported and its correlation to the operator location.
- The aircraft automatically initiates a pre-flight self-test (PFST) of the Remote ID system before takeoff and cannot take off if it does not pass the PFST ^[1]. The results of the PFST of the Remote ID system can be viewed in a DJI flight control app such as DJI GS RTK and DJI Pilot.
- The aircraft monitors the Remote ID system functionality from pre-flight to shut down. If the Remote ID system malfunctions or has a failure, an alarm will be displayed in a DJI flight control app such as DJI GS RTK and DJI Pilot.
- The user shall keep the DJI flight control app running in the foreground and always allow it to obtain the location information of the remote controller.
- Developers who develop third-party applications based on the DJI Mobile SDK shall obtain and display the PFST results and the failure status of the Remote ID system during operation by calling specific APIs ^[2].

Footnotes

[1] The pass criterion for PFST is that the hardware and software of the Remote ID required-data source and transmitter radio in the Remote ID system are functioning properly.

[2] For detailed APIs information, please visit <https://developer.dji.com/mobile-sdk/>.

DJI Support
<http://www.dji.com/support>

This content is subject to change.

Download the latest version from
<http://www.dji.com/phantom-4-rtk>

If you have any questions about this document, please contact
DJI by sending a message to **DocSupport@dji.com**.

PHANTOM is a trademark of DJI.
Copyright © 2023 DJI All Rights Reserved.